

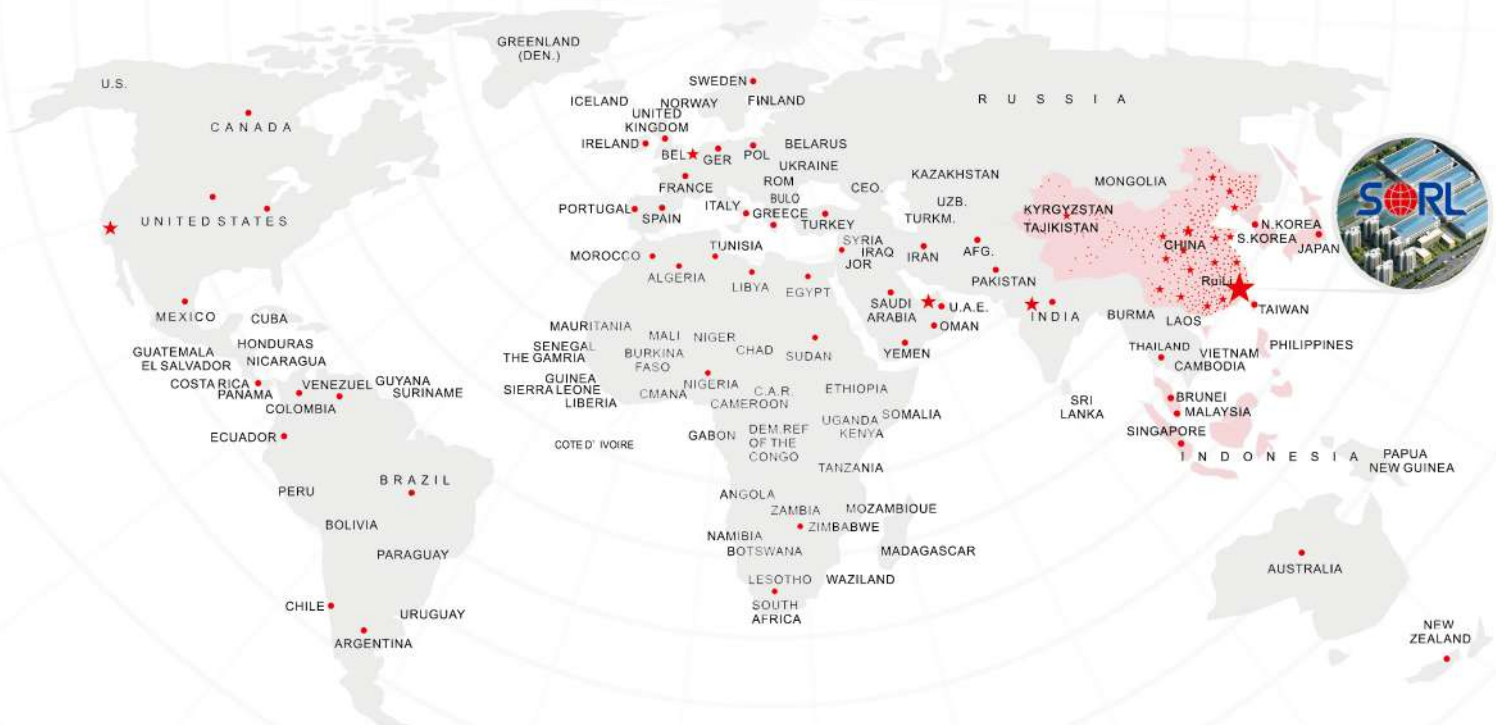

SALES NETWORK





COMPANY PROFILE

SORL Auto Parts, Inc. located in Ruian, Zhejiang Province, a coastal city by East China Sea, is a major manufacturer of spare parts for all commercial vehicles brands. With a registered capital of 53,788,900 US Dollar and about 4000 employees working in a Plant of 270,000 m², SORL was successfully listed on the main-board of NASDAQ global market in 2006.

The company supplies air brake systems and relative components to more than 70 OEM customers in China, such as FAW and DongFeng, and were awarded several times as Excellent Supplier. Moreover, it has 7 sales branches and established relations with hundreds of distributors all around the world, as well as a distribution network with 27 authorized distributors and 800 sub-distributors all over China.

Decades of effort makes SORL the biggest Manufacturing Base of Air Brake Valves in China, China Top 100 Auto Parts Enterprises, National Export Base of Auto Parts, China Top 500 Competitive Large Enterprises, Most Competitive Top 50 of Chinese Non-governmental Enterprises, and its products were awarded as “China Top Brand”

SORL wins the market share with its advantages in technique, quality, product variety, as well as its unique service. Guided by the orientation of market, service, quality, science and technology, the company has been making progress all the time. SORL is dedicating itself to continuously satisfying customers and it believes that it will create a more brilliant future with partners worldwide.

HIGH STANDARD MANUFACTURING

One main factor that's contributed to SORL's improvement in quality has been the implementation and use of modern and advanced equipment. SORL is always looking at the latest manufacturing technology and processes in order to continuously improve productivity and quality. Dedicated to 'quality' SORL makes no compromise when delivering new products to a customer, and ensures all products delivered match the customer's specification. SORL products are second to none and meet global quality standards in their class and range of manufacture. In keeping with this, SORL has put in place rigorous quality control procedures to ensure the supply of products are defect free.



R&D Department



Tooling Workshop



Die-Casting Workshop



Stamping Workshop



Machining Workshop



Assembly Workshop

QUALITY GUARANTEE

Certificate

Standard ISO / TS 16949:2009
(7th edition, 2009-05-19)

Certificate Register No. 01 111 019323
IATF Certificate No. 0232035

Certificate Holder: Ruili Group Ruian Auto Parts Co., Ltd.
No. 2666 Kaitang Avenue, Ruian Development Zone,
Ruian, Zhejiang Province 325200, P. R. China

Scope: Design and Manufacturing of Air Brake System Components, Hydraulic Brake System Components, Power Steering Pumps, Electric Parts (Switches, Wiper Blade Assy., Solenoid Valves, Horns, Flashers, Relays and Window Regulators)

Proof has been furnished by means of an audit that the requirements of ISO / TS: 16949:2009 are met.

Issue date/Expiry date: The certificate is valid from 2016-02-19 until 2018-06-14.

Release date: 2016-02-19

T. Hirsch
TÜV Rheinland Cert Group
Am Lieben Stein • 51105 Köln
Germany

 TÜVRheinland®
Precisely Right.

РОССИЙСКАЯ ФЕДЕРАЦИЯ СЕРТИФИКАТ СООТВЕТСТВИЯ (обязательная сертификация)

№ C-CN.AG.88.B.68741 ТР 18029TT
(1-значный номер стандарта)

ЗАЯВИТЕЛЬ: "RUILI GROUP RUIAN AUTO PARTS CO., LTD." Адрес: No. 1169 Yumeng Road, Ruian Economic Development Zone, Zhejiang, 325200, China, Китай. Телефон: 0086757909800.
(полное наименование заявителя)

ИЗГОТОВИТЕЛЬ: "RUILI GROUP RUIAN AUTO PARTS CO., LTD." Адрес: No. 1169 Yumeng Road, Ruian Economic Development Zone, Zhejiang, 325200, China, Китай. Телефон: 0086757909800.
(полное наименование изготовителя)

ОРГАН ПО СЕРТИФИКАЦИИ: ООО "Росстандарт", 125438, г. Москва, Златоустовский переулок, дом 18А, 3 этаж, комната 25. Контакт: (495) 626-2642, факс: (495) 626-2442, адрес электронной почты: info@rosstandart.ru, ОГРН: 1117746038430. Адресат: иерархията № РОСС RU.0001.11A7.98 и/или федеральной службы по метрологии.

ПОДЛЕЖАЕТ, ЧТО: Комбинаты транспортных средств т.н. "SORKI", изделия класса ПРОДУКЦИЯ Серийный выпуск.

СООТВЕТСТВУЕТ ТРЕБОВАНИЯМ: Технический регламент о безопасности колесных транспортных средств (Постановление Правительства РФ от 19.09.2009 N 720)

ПРОВЕДЕННЫЕ ИССЛЕДОВАНИЯ: Протокол № 4192-Т057-8698 от 03.03.2014 г., Испытания в соответствии с требованиями Дипломатическое соглашение ООО "Юлсер", пат. № РОСС RU.0001.21A95 от 28.10.2011 и 28.10.2015, адрес: 437000, Самарская обл., Марш. д. 5, стр. 207

ПРЕДСТАВЛЕННЫЕ ДОКУМЕНТЫ: Сертификат, протокол испытаний, декларация о соответствии, декларация о соответствии, протокол испытаний, протокол испытаний, протокол испытаний, протокол испытаний

СРОК ДЕЙСТВИЯ СЕРТИФИКАТА СООТВЕТСТВИЯ: с 03.03.2014 по 02.03.2017

ИИИ ОК 005 (ОКТИ) 45 4100
ИИИ ЕКТС
ИИИ ТН ВЭД России 3917.31.000.9

Л.Л. Суляев
П.В. Мануйлов

Certificate of Registration

Intertek

This is to certify that the environmental management system of

Ruili Group Ruian Auto Parts Co., Ltd.

Registered Address: No. 1169 Yumeng Road, Ruian Economic Development Zone, Zhejiang Province, P. R. China
Production Address: No. 2666, Development Road, Ruian Economic Development Zone, Zhejiang, P. R. China

has been assessed and registered by Intertek as conforming to the requirements of

ISO 14001: 2004

The environmental management system is applicable to the management of environmental aspects related to:

Design, manufacturing and sales of automotive brake system brake components.

Organization Code: 75906785-X
Certificate Number: 7384-EM5
Original Issue Date: 14 June 2006
Certificate Issue Date: 08 May 2015
Certificate Expiry Date: 09 June 2018

Ch. Hillier
Authorized Signatory: Chair Intertek - President Business Assurance
Intertek Certification Limited, 100 Victoria Park, Victoria Place, Derby DE24 0DT, United Kingdom
Intertek Certification Limited is a UKAS accredited body under the scope of accreditation no. 014



Intertek, Intertek, Intertek, Intertek, Intertek, Intertek

Certificate of Registration

Intertek

This is to certify that the occupational health & safety management system of

Ruili Group Ruian Auto Parts Co., Ltd.

Registered Address: No. 1169 Yumeng Road, Ruian Economic Development Zone, Zhejiang Province, P. R. China
Production Address: No. 2666, Development Road, Ruian Economic Development Zone, Zhejiang, P. R. China

has been assessed and registered by Intertek as conforming to the requirements of

OHSAS 18001: 2007

The occupational health & safety management system is applicable to the management of occupational health and safety risks associated with:

Design, manufacturing and sales of automotive brake system brake components.

Organization Code: 75906785-X
Certificate Number: 7384-OHS
Original Issue Date: 09 August 2006
Certificate Issue Date: 08 May 2015
Certificate Expiry Date: 30 May 2018

Ch. Hillier
Authorized Signatory: Chair Intertek - President Business Assurance
Intertek Certification Limited, 100 Victoria Park, Victoria Place, Derby DE24 0DT, United Kingdom
Intertek Certification Limited is a UKAS accredited body under the scope of accreditation no. 014



Intertek, Intertek, Intertek, Intertek, Intertek, Intertek

SORL adopts a number of advanced management systems, especially ISO/TS16949 which is specially required by the international auto industry, to control the whole process of production, from designing, manufacturing, packing to aftermarket service, ensuring the stability and consistency of products. Recently the company is actively bringing in Six Sigma Management to achieve further improvement.

CATALOGUE INSTRUCTION

We list the majority of our parts for various kinds of commercial vehicle throughout this catalogue. Pictures, cross references and main specifications will assist identification.

How to Navigate

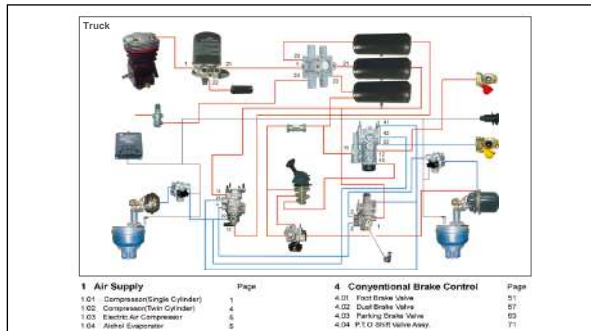

On page P1-P2 you will have an overview of how the parts in catalogue are organized.

TABLE OF CONTENT 1

Product	No.	Page
Air Dryer Base	1.32	35
Air Dryer Heater	1.15	42
Air Dryer(Single Cammer)	1.11	29
Air Dryer(Twin Cammer)	1.10	27
Air Hose	0.07	210
Air Processing Unit	1.00	28
Air Reservoir	1.01	72
Aisher Compressor	1.04	17
Anti-Compound Valve	4.19	139
Anti-Freeze Pump	1.10	43
Automatic Drain Valve	2.04	75
Automatic Slack Adjusters	15.02	289
Brake Chamber(Cam Brake)	12.04	245
Brake Chamber(Disc Brake)	12.02	243
Brake Chamber(Wedge Brake)	12.03	245
Bush	0.06	159
Cable	0.09	160
Cable Signal	0.05	209
Charging (Overflow) Valve	2.05	60
Check Valve	11.01	212
Clutch Master Cylinder	0.05	197
Clutch Servo	0.01	191

On page P3-P4 you will find the contents of parts organized in alphabetic order.

INDEX BY PART MANUFACTURERS

Cross Ref.	SORL No.	SORL EU No.	Page	Cross Ref.	SORL No.	SORL EU No.	Page
085 04	RL318J204	3510 021 205 0	146	10570	RL318J4A	3510 021 191 0	147
085 04	RL318J2A	3510 021 191 0	146	10520	RL318J8A	3510 021 191 0	145
085 05	RL318H204	3510 006 002 0	144	10528	RL318J12	3510 021 143 0	145
085 05	RL318H2A	3510 006 006 0	144	10581	RL318J8	3510 021 191 0	145
085 06	RL318T7	3510 021 200 0	151	10582	RL318J8A	3510 021 191 0	145
085 06	RL318T706	3510 021 200 0	151	10587	RL318J9A	3510 021 191 0	147
085 06	RL318T708	3510 021 200 0	151	10594	RL318J20B	3510 021 191 0	147
085 06	RL318T7-C	3510 021 200 0	151	10594	RL318J8E	3510 021 191 0	147
085 04	RL318H4C1	3510 006 004 0	119	10595	RL318J8B	3510 021 191 0	145
085 04	RL318H4E2	3510 006 006 0	118	10592	RL318J10	3510 021 191 0	145
085 06	451 0702240	451 0702245	330	10598	RL318J10P	3510 021 191 0	147
085 07	451 0002241	451 0002245	330	10598	RL318J10	3510 021 191 0	147
085 07	451 0002242	451 0002245	330	10598	RL318J10	3510 021 191 0	147
085 07	451 0002243	451 0002245	330	10598	RL318J10	3510 021 191 0	147
085 07	451 0002244	451 0002245	330	10598	RL318J10	3510 021 191 0	147
085 07	451 0002245	451 0002245	330	10598	RL318J10	3510 021 191 0	147
085 07	451 0002246	451 0002245	330	10598	RL318J10	3510 021 191 0	147
085 07	451 0002247	451 0002245	330	10598	RL318J10	3510 021 191 0	147
085 07	451 0002248	451 0002245	330	10598	RL318J10	3510 021 191 0	147
085 07	451 0002249	451 0002245	330	10598	RL318J10	3510 021 191 0	147
085 07	451 0002250	451 0002245	330	10598	RL318J10	3510 021 191 0	147
085 07	451 0002251	451 0002245	330	10598	RL318J10	3510 021 191 0	147
085 07	451 0002252	451 0002245	330	10598	RL318J10	3510 021 191 0	147
085 07	451 0002253	451 0002245	330	10598	RL318J10	3510 021 191 0	147
085 07	451 0002254	451 0002245	330	10598	RL318J10	3510 021 191 0	147
085 07	451 0002255	451 0002245	330	10598	RL318J10	3510 021 191 0	147
085 07	451 0002256	451 0002245	330	10598	RL318J10	3510 021 191 0	147
085 07	451 0002257	451 0002245	330	10598	RL318J10	3510 021 191 0	147
085 07	451 0002258	451 0002245	330	10598	RL318J10	3510 021 191 0	147
085 07	451 0002259	451 0002245	330	10598	RL318J10	3510 021 191 0	147
085 07	451 0002260	451 0002245	330	10598	RL318J10	3510 021 191 0	147
085 07	451 0002261	451 0002245	330	10598	RL318J10	3510 021 191 0	147
085 07	451 0002262	451 0002245	330	10598	RL318J10	3510 021 191 0	147
085 07	451 0002263	451 0002245	330	10598	RL318J10	3510 021 191 0	147
085 07	451 0002264	451 0002245	330	10598	RL318J10	3510 021 191 0	147
085 07	451 0002265	451 0002245	330	10598	RL318J10	3510 021 191 0	147
085 07	451 0002266	451 0002245	330	10598	RL318J10	3510 021 191 0	147
085 07	451 0002267	451 0002245	330	10598	RL318J10	3510 021 191 0	147
085 07	451 0002268	451 0002245	330	10598	RL318J10	3510 021 191 0	147
085 07	451 0002269	451 0002245	330	10598	RL318J10	3510 021 191 0	147
085 07	451 0002270	451 0002245	330	10598	RL318J10	3510 021 191 0	147
085 07	451 0002271	451 0002245	330	10598	RL318J10	3510 021 191 0	147
085 07	451 0002272	451 0002245	330	10598	RL318J10	3510 021 191 0	147
085 07	451 0002273	451 0002245	330	10598	RL318J10	3510 021 191 0	147
085 07	451 0002274	451 0002245	330	10598	RL318J10	3510 021 191 0	147
085 07	451 0002275	451 0002245	330	10598	RL318J10	3510 021 191 0	147
085 07	451 0002276	451 0002245	330	10598	RL318J10	3510 021 191 0	147
085 07	451 0002277	451 0002245	330	10598	RL318J10	3510 021 191 0	147
085 07	451 0002278	451 0002245	330	10598	RL318J10	3510 021 191 0	147
085 07	451 0002279	451 0002245	330	10598	RL318J10	3510 021 191 0	147
085 07	451 0002280	451 0002245	330	10598	RL318J10	3510 021 191 0	147
085 07	451 0002281	451 0002245	330	10598	RL318J10	3510 021 191 0	147
085 07	451 0002282	451 0002245	330	10598	RL318J10	3510 021 191 0	147
085 07	451 0002283	451 0002245	330	10598	RL318J10	3510 021 191 0	147
085 07	451 0002284	451 0002245	330	10598	RL318J10	3510 021 191 0	147
085 07	451 0002285	451 0002245	330	10598	RL318J10	3510 021 191 0	147
085 07	451 0002286	451 0002245	330	10598	RL318J10	3510 021 191 0	147
085 07	451 0002287	451 0002245	330	10598	RL318J10	3510 021 191 0	147
085 07	451 0002288	451 0002245	330	10598	RL318J10	3510 021 191 0	147
085 07	451 0002289	451 0002245	330	10598	RL318J10	3510 021 191 0	147
085 07	451 0002290	451 0002245	330	10598	RL318J10	3510 021 191 0	147
085 07	451 0002291	451 0002245	330	10598	RL318J10	3510 021 191 0	147
085 07	451 0002292	451 0002245	330	10598	RL318J10	3510 021 191 0	147
085 07	451 0002293	451 0002245	330	10598	RL318J10	3510 021 191 0	147
085 07	451 0002294	451 0002245	330	10598	RL318J10	3510 021 191 0	147
085 07	451 0002295	451 0002245	330	10598	RL318J10	3510 021 191 0	147
085 07	451 0002296	451 0002245	330	10598	RL318J10	3510 021 191 0	147
085 07	451 0002297	451 0002245	330	10598	RL318J10	3510 021 191 0	147
085 07	451 0002298	451 0002245	330	10598	RL318J10	3510 021 191 0	147
085 07	451 0002299	451 0002245	330	10598	RL318J10	3510 021 191 0	147
085 07	451 0002300	451 0002245	330	10598	RL318J10	3510 021 191 0	147
085 07	451 0002301	451 0002245	330	10598	RL318J10	3510 021 191 0	147
085 07	451 0002302	451 0002245	330	10598	RL318J10	3510 021 191 0	147
085 07	451 0002303	451 0002245	330	10598	RL318J10	3510 021 191 0	147
085 07	451 0002304	451 0002245	330	10598	RL318J10	3510 021 191 0	147
085 07	451 0002305	451 0002245	330	10598	RL318J10	3510 021 191 0	147
085 07	451 0002306	451 0002245	330	10598	RL318J10	3510 021 191 0	147
085 07	451 0002307	451 0002245	330	10598	RL318J10	3510 021 191 0	147
085 07	451 0002308	451 0002245	330	10598	RL318J10	3510 021 191 0	147
085 07	451 0002309	451 0002245	330	10598	RL318J10	3510 021 191 0	147
085 07	451 0002310	451 0002245	330	10598	RL318J10	3510 021 191 0	147
085 07	451 0002311	451 0002245	330	10598	RL318J10	3510 021 191 0	147
085 07	451 0002312	451 0002245	330	10598	RL318J10	3510 021 191 0	147
085 07	451 0002313	451 0002245	330	10598	RL318J10	3510 021 191 0	147
085 07	451 0002314	451 0002245	330	10598	RL318J10	3510 021 191 0	147
085 07	451 0002315	451 0002245	330	10598	RL318J10	3510 021 191 0	147
085 07	451 0002316	451 0002245	330	10598	RL318J10	3510 021 191 0	147
085 07	451 0002317	451 0002245	330	10598	RL318J10	3510 021 191 0	147
085 07	451 0002318	451 0002245	330	10598	RL318J10	3510 021 191 0	147
085 07	451 0002319	451 0002245	330	10598	RL318J10	3510 021 191 0	147
085 07	451 0002320	451 0002245	330	10598	RL318J10	3510 021 191 0	147
085 07	451 0002321	451 0002245	330	10598	RL318J10	3510 021 191 0	147
085 07	451 0002322	451 0002245	330	10598	RL318J10	3510 021 191 0	147
085 07	451 0002323	451 0002245	330	10598	RL318J10	3510 021 191 0	147
085 07	451 0002324	451 0002245	330	10598	RL318J10	3510 021 191 0	147
085 07	451 0002325	451 0002245	330	10598	RL318J10	3510 021 191 0	147
085 07	451 0002326	451 0002245	330	10598	RL318J10	3510 021 191 0	147
085 07	451 0002327	451 0002245	330	10598	RL318J10	3510 021 191 0	147
085 07	451 0002328	451 0002245	330	10598	RL318J10	3510 021 191 0	147
085 07	451 0002329	451 0002245	330	10598	RL318J10	3510 021 191 0	147
085 07	451 0002330	451 0002245	330	10598	RL318J10	3510 021 191 0	147
085 07	451 0002331	451 0002245	330	10598	RL318J10	3510 021 191 0	147
085 07	451 0002332	451 0002245	330	10598	RL318J10	3510 021 191 0	

STANDARD APPLICATIONS

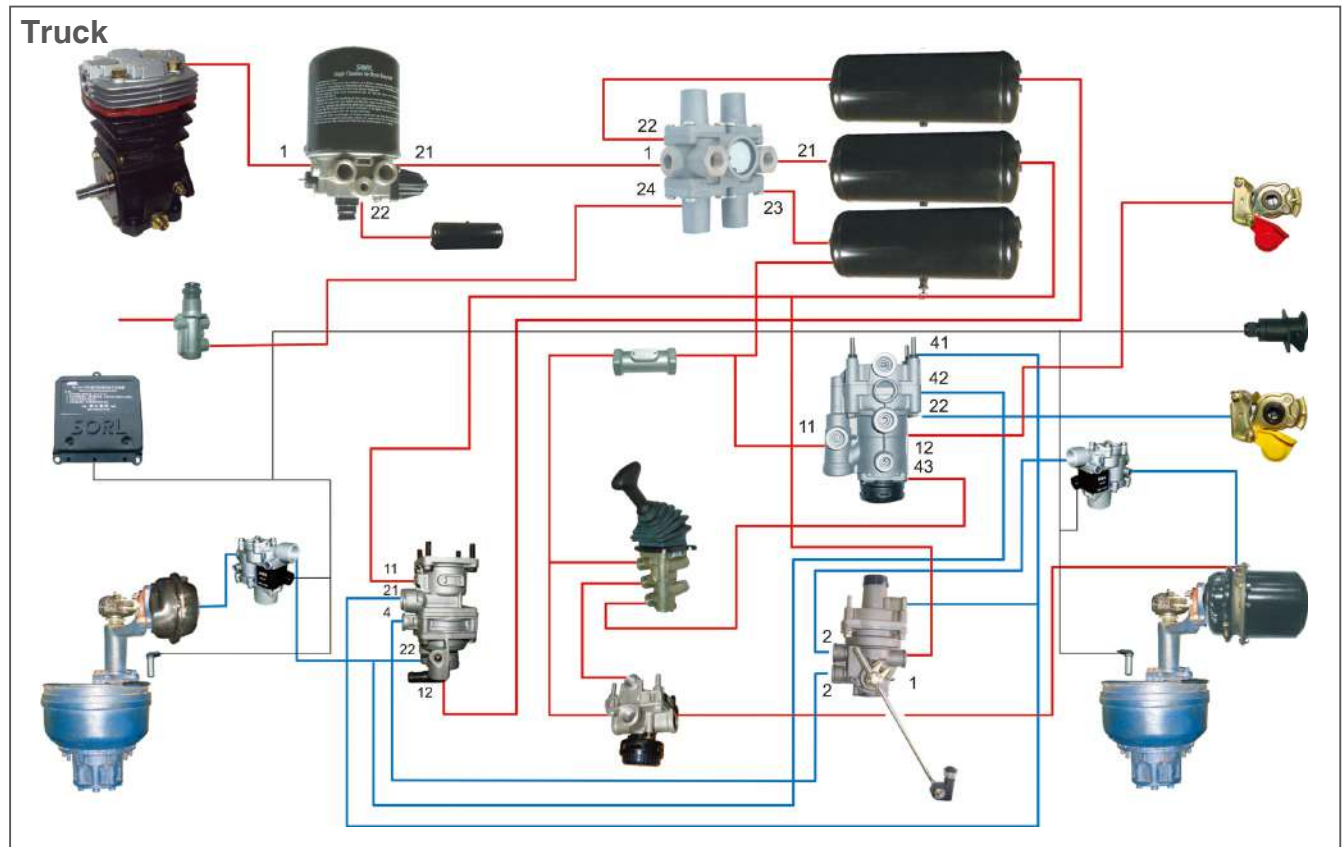

1 Air Supply

	Page
1.01 Compressor(Single Cylinder)	1
1.02 Compressor(Twin Cylinder)	3
1.03 Electric Air Compressor	5
1.04 Alcohol Evaporator	17
1.05 Condenser	17
1.06 Unloader Valve	17
1.07 Pressure Protection Valve	21
1.08 Governor	22
1.09 Air Processing Unit	26
1.10 Air Dryer(Twin Cannister)	27
1.11 Air Dryer(Single Cannister)	28
1.12 Air Dryer Base	38
1.13 Air Dryer Cartridge	40
1.14 Silencer	41
1.15 Air Dryer Heater	42
1.16 Anti-Freezer Pump	43

2 Air Protection

	Page
2.01 Four Circuit Protection Valve	46
2.02 Multi Circuit Protection Valve	55
2.03 Two Circuit Protection Valve	57
2.04 Three Circuit Protection Valve	57
2.05 Safety Valve	59
2.06 Charging (Overflow) Valve	60
2.07 Pressure Limiting Valve	63
2.08 Pressure Protection Valve	68
2.09 Transmission Air Regulator	70
2.10 Pressure Switch	70

3 Air Storage

	Page
3.01 Air Reservoir	72
3.02 Test Points	73
3.03 Manual Drain Valve	74
3.04 Automatic Drain Valve	75

4 Conventional Brake Control

	Page
4.01 Foot Brake Valve	77
4.02 Dual Brake Valve	83
4.03 Parking Brake Valve	93
4.04 P.T.O Shift Valve Assy.	102
4.05 Control Valve	102
4.06 LSV Relay, Mech Controlled	106
4.07 LSV Relay, Pneu.Controlled	109
4.08 LSV Relay, Emergency Valve	110
4.09 Spring Box	110
4.10 Quick Release Valve	112
4.11 Trailer Control Valve	121
4.12 Trailer Protection Valve	123
4.13 Tractor Protection Valve	125
4.14 Sealco Ratio Relay Valve	125
4.15 Trailer Spring Relay Valve	127
4.16 Trailer Spring Brake Valve	128
4.17 Relay Emergency Valve	130
4.18 Release Valve	136
4.19 Anti-Compound Valve	139
4.20 Relay Valve	139

5 Electronic Brake Control Units

	Page
5.01 ECU	156
5.02 Modulator Valve	156
5.03 Dual Modulator Valve	156
5.04 Solenoid Modulator	157
5.05 Speed Sensor	158
5.06 Bush	159
5.07 Grease	160
5.08 Cable	160
5.09 Pole wheel	162

STANDARD APPLICATIONS

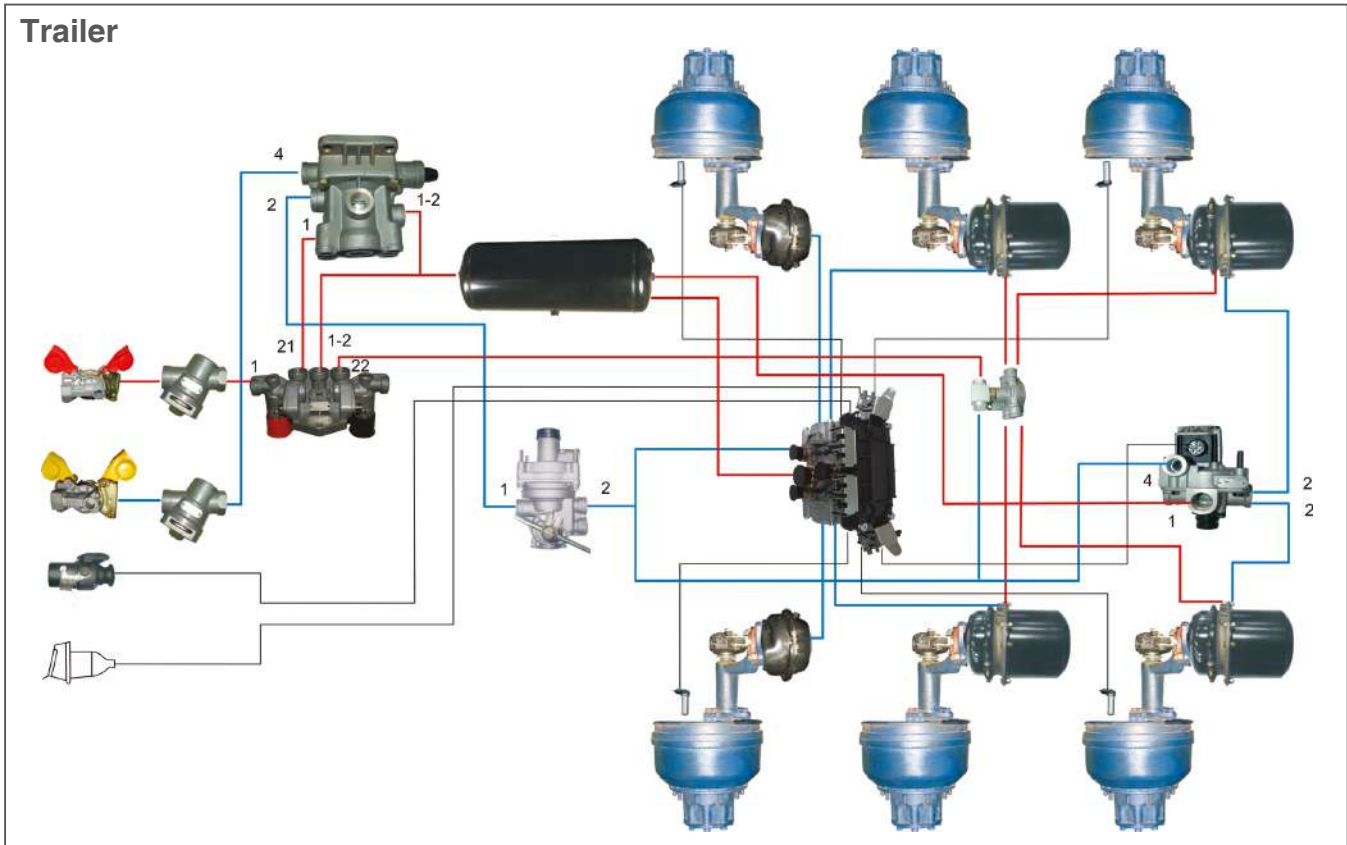

6 Air Suspension Control

	Page
6.01 Levelling Valve	163
6.02 Rotary Slide Valve	171
6.03 Raise/Lower Valve	171
6.04 Lift Axle Control Valve	171

7 Electronic Air Suspension Control

	Page
7.01 Solenoid Valve For ECAS	173
7.02 Pressure Control Valve For ELC	177
7.03 Height Sensor For ECAS	178
7.04 Level Sensor	179
7.05 Pressure Sensor	179

8 Drive Line

	Page
8.01 Clutch Servo	181
8.02 Pipe Connector	197
8.03 Clutch Master Cylinder	197
8.04 Shift Knob	198

9 Trailer Coupling

	Page
9.01 Shut Off Cock	203
9.02 Coupling Head	203
9.03 Coupling Bracket	208
9.04 Line Filter	208
9.05 Cable Spiral	209
9.06 Power Cable	209
9.07 Air Hose	210
9.08 Electric Cable	211
9.09 Connecting Cable	211

10 Bus Specific Devices

	Page
10.01 Door Control Valve	211

11 Universal Application Devices

	Page
11.01 Check Valve	212
11.02 Double Check Valve	215
11.03 TR-3 Inversion Valve	218
11.04 Synchro Valve	218
11.05 Control Cylinder	219
11.06 Double Acting Cylinder	220
11.07 Exhaust Brake Valve	222
11.08 Directional Control Valve	222
11.09 Gearbox Valve	226
11.10 Transmission Slave Valve	228
11.11 Follow-up Valve	228
11.12 Control Valve	228
11.13 Electronic Valve	238
11.14 Proportional Valve	240

12 Brake Actuation

	Page
12.01 Yoke	242
12.02 Brake Chamber(Disc Brake)	243
12.03 Brake Chamber(Wedge Brake)	246
12.04 Brake Chamber(Cam Brake)	246
12.05 Spring Brake(Disc Brake)	262
12.06 Spring Brake(Wedge Brake)	267
12.07 Spring Brake(Cam Brake)	268
12.08 Diaphragm	277

13 Axle Devices

	Page
13.01 Control Arm Type	288
13.02 Automatic Slack Adjusters	289
13.03 Manual Slack Adjusters	330

TABLE OF CONTENT 1

Product	No.	Page
Air Dryer Base	1.12	38
Air Dryer Heater	1.15	42
Air Dryer(Single Cannister)	1.11	28
Air Dryer(Twin Cannister)	1.10	27
Air Hose	9.07	210
Air Processing Unit	1.09	26
Air Reservoir	3.01	72
Alcohol Evaporator	1.04	17
Anti-Compound Valve	4.19	139
Anti-Freezer Pump	1.16	43
Automatic Drain Valve	3.04	75
Automatic Slack Adjusters	13.02	289
Brake Chamber(Cam Brake)	12.04	246
Brake Chamber(Disc Brake)	12.02	243
Brake Chamber(Wedg Brake)	12.03	246
Bush	5.06	159
Cable	5.08	160
Cable Spiral	9.05	209
Charging (Overflow) Valve	2.06	60
Check Valve	11.01	212
Clutch Master Cylinder	8.03	197
Clutch Servo	8.01	181
Compressor(Single Cylinder)	1.01	1
Compressor(Twin Cylinder)	1.02	3
Condenser	1.05	17
Connecting Cable	9.09	211
Control Arm Type	13.01	288
Control Cylinder	11.05	219
Control Valve	4.05	102
Control Valve	11.12	228
Coupling Bracket	9.03	208
Coupling Head	9.01	203
Desiccant Cartridge	1.13	40
Diamphrgm	12.08	277
Directional Control Valve	11.08	222
Door Control Valve	10.01	211
Double Acting Cylinder	11.06	220
Double Check Valve	11.02	215
Dual Brake Valve	4.02	83
Dual Modulator Valve	5.03	156
ECU	5.01	156
Electric Air Compressor	1.03	5
Electric Cable	9.08	211
Electronic Valve	11.13	238
Exhaust Brake Valve	11.07	222
Follow-up Valve	11.11	228
Foot Brake Valve	4.01	77
Four Circuit Protection Valve	2.01	46
Gearbox Valve	11.09	226
Governor	1.08	22
Grease	5.07	160
Height Sensor For ECAS	7.03	178
Level Sensor	7.04	179
Levelling Valve	6.01	163

Product	No.	Page
Lift Axle Control Valve	6.04	171
Line Filter	9.04	208
LSV Relay, Emergency Valve	4.08	110
LSV Relay, Mech Controlled	4.06	106
LSV Relay, Pneu.Controlled	4.07	109
Manual Drain Valve	3.03	74
Manual Slack Adjusters	13.03	330
Modulator Valve	5.02	156
Multi Circuit Protection Valve	2.02	55
P.T.O Shift Valve Assy.	4.04	102
Parking Brake Valve	4.03	93
Pipe Connector	8.02	197
Pole wheel	5.09	162
Power Cable	9.06	209
Pressure Control Valve For ELC	7.02	177
Pressure Limiting Valve	2.07	63
Pressure Protection Valve	1.07	21
Pressure Protection Valve	2.08	68
Pressure Sensor	7.05	179
Pressure Switch	2.10	70
Proportional Valve	11.14	240
Quick Release Valve	4.10	112
Raise/Lower Valve	6.03	171
Relay Emergency Valve	4.17	130
Relay Valve	4.20	139
Release Vale	4.18	136
Rotary Slide Valve	6.02	171
Safety Valve	2.05	59
Sealco Ratio Relay Valve	4.14	125
Shift Knob	8.04	198
Shut Off Cock	9.01	203
Silencer	1.14	41
Solenoid Modulator	5.04	157
Solenoid Valve For ECAS	7.01	173
Speed Sensor	5.05	158
Spring Box	4.09	110
Spring Brake(Cam Brake)	12.07	268
Spring Brake(Disc Brake)	12.05	262
Spring Brake(Wedge Brake)	12.06	267
Synchro Valve	11.04	218
Test Points	3.02	73
Three Circuit Protection Valve	2.04	57
TR-3 Inversion Valve	11.03	218
Tractor Protection Valve	4.13	125
Trailer Control Valve	4.11	121
Trailer Protection Valve	4.12	123
Trailer Spring Brake Valve	4.16	128
Trailer Spring Relay Valve	4.15	127
Transmission Air Regulator	2.09	70
Transmission Slave Valve	11.10	228
Two Circuit Protection Valve	2.03	57
Unloader	1.06	17
Yoke	12.01	242

INDEX BY PART MANUFACTURERS

BENDIX

Cross Ref.	SORL No.	SORL EU No	Page	Cross Ref.	SORL No.	SORL EU No	Page
065104	RL3518JC04	3518 021 035 0	146	103010	RL3518JH-A	3518 021 019 0	147
065104	RL3518JL-A	3518 021 023 0	146	103028	RL3518JB-A	3518 021 009 0	145
065125	RL3518HC04	3518 008 022 0	144	103028	RL3518JC12	3518 021 043 0	145
065125	RL3518HC-A	3518 008 008 0	144	103061	RL3599AB	3599 001 009 0	129
065145	RL3518TF	3518 023 001 0	151	103061	RL3599AB-A	3599 004 014 0	129
065145	RL3518TF05	3518 023 005 0	151	103081	RL3512PA05	3512 016 001 0	20
065146	RL3518TF06	3518 023 006 0	151	103294	RL3518JC08	3518 021 039 0	147
065146	RL3518TF-C	3518 023 004 0	151	103294	RL3518JH-B	3518 021 020 0	147
065154	RL3516WA01	3516 050 004 0	119	103833	RL3518JB-B	3518 021 010 0	145
065154	RL3516WA02	3516 050 006 0	119	103833	RL3518JC13	3518 021 044 0	145
065166	455127002245	455127002245	330	103835	RL3518JC09	3518 021 040 0	147
065167	455140002245	455140002245	330	103835	RL3518JH-C	3518 021 021 0	147
065170	455140002105	455140002105	330	103912	RL3518JC05	3518 021 036 0	146
065172	455152002105	455152002105	330	103912	RL3518JC-B	3518 021 018 0	146
065174	455140002285	455140002285	330	103976N	RL3531HA06	3531 014 006 0	69
065175	455152001285	455152001285	330	104165	RL3518HC05	3518 008 023 0	144
065176	455152002285	455152002285	330	104165	RL3518HG-A	3518 008 013 0	144
065177	455152002375	455152002375	330	104345	RL3518JC10	3518 021 041 0	148
065178	455140002375	455140002375	330	104345	RL3518JH-D	3518 021 022 0	147
065179	455152001375	455152001375	330	104358	RL3513DB	3513 003 002 0	41
065181	RL3518JC07	3518 021 038 0	147	104561	RL3518JC06	3518 021 037 0	146
065181	RL3518JC-A	3518 021 017 0	146	104561	RL3518JL-B	3518 021 024 0	146
065182	455140001375	455140001375	330	104574	RL3518JC11	3518 021 042 0	148
065224	RL3511XD03	3511 022 003 0	37	104574	RL3518JK-A	3518 021 015 0	148
065225	RL3511XD02	3511 022 002 0	37	106313	RL3518JB-C	3518 021 011 0	145
065226	RL3511XD04	3511 022 004 0	37	106313	RL3518JC14	3518 021 045 0	145
065225	RL3511XD08	3511 022 008 0	37	107455	RL3518SS05	3518 029 005 0	148
065303	RL3518HC03	3518 008 021 0	143	107794	RL3513DA	3513 003 001 0	41
065303	RL3518HS	3518 008 016 0	143	107881	RL3516FD09	3516 006 009 0	117
065309	RL3518HC06	3518 008 024 0	144	107881	RL3516FF	3516 006 005 0	117
065309	RL3518HC-C	3518 008 012 0	144	109685	RL3511XD05	3511 022 005 0	37
065316	RL3526HC08	3526 024 001 0	103	109869	RL3511LB01	3511 012 031 0	43
065316	RL3526HC09	3526 024 002 0	103	109871	RL3511LB01	3511 012 031 0	43
065356	RL3526HC10	3526 025 001 0	103	110139	RL3527FD	3527 005 020 0	134
065356	RL3526HC11	3526 025 002 0	103	110170	RL3527GA	3527 006 001 0	126
065403	455140001245	455140001245	330	110170	RL3527GA01	3527 006 010 0	126
065437	RL3599BC	3599 001 006 0	128	110171	RL3527GA03	3527 006 012 0	127
065437	RL3599BC-A	3599 001 013 0	128	110171	RL3527GA-B	3527 006 007 0	127
065438	RL3599BA	3599 001 004 0	128	110191	RL3527GA02	3527 006 011 0	126
065438	RL3599BA-A	3599 001 015 0	128	110191	RL3527GB-A	3527 006 008 0	126
065439	RL3599BD	3599 001 007 0	128	110197	RL3518QB01	3518 028 001 0	135
065439	RL3599BD-A	3599 001 017 0	128	110200	RL3527FB	3527 005 002 0	134
065440	RL3599BB	3599 001 001 0	128	110205	RL3527FC	3527 005 003 0	134
065440	RL3599BB-A	3599 001 016 0	128	110310	RL3527GA05	3527 006 014 0	126
065650P	RL3511XD06	3511 022 006 0	37	110310	RL3527GB	3527 006 003 0	126
065677	RL3531FA	3531 005 001 0	60	110315	RL3527GA04	3527 006 013 0	126
065706	RL3522YD02	3522 012 002 0	123	110315	RL3527GA-A	3527 006 002 0	126
101100	RL3514GD02	3514 007 020 0	84	110415	RL3518UA01	3518 026 002 0	150
101112	RL3599CA	3599 001 002 0	127	110460	RL3527FA	3527 005 001 0	134
101112	RL3599CC	3599 001 011 0	127	140270	RL3531XA03	3531 015 003 0	70
101135N	RL3512PA-B	3512 015 008 0	21	140280	RL3531XA02	3531 015 002 0	69
101311	RL3516WA	3516 050 001 0	119	140370	RL3531XA01	3531 015 001 0	69
101311	RL3516WA03	3516 050 007 0	119	205105	RL3513JA	3513 011 001 0	59
101622	RL3599CB	3599 001 005 0	127	225892	RL3526HC06	3526 023 001 0	103
101622	RL3599CB-A	3599 001 012 0	127	225892	RL3526HC07	3526 023 002 0	103
101818	RL3514JA02	3514 017 001 0	87	227871	RL3525CA02	3525 011 001 0	212
101860	RL3548JA01	3548 026 001 0	230	228750	RLD5-M026	3757 003 001 0	70
102626	RL3518JC	3518 021 003 0	145	229505	RL3516VA01	3516 060 001 0	117
102626	RL3518JC02	3518 021 032 0	146	229505	RL3516VA07	3516 060 007 0	117
102761	RL3599AA	3599 001 008 0	129	229507	RL3516VA02	3516 060 002 0	117
102761	RL3599AA-A	3599 001 019 0	129	229507	RL3516VA05	3516 060 005 0	118
103009	RL3518HC02	3518 008 020 0	144	229509	RL3516VA03	3516 060 003 0	118
103009	RL3518HC-B	3518 008 009 0	144	229509	RL3516VA06	3516 060 006 0	118
103010	RL3518JC03	3518 021 033 0	147	229635	RL3526HC01	3526 021 001 0	102

INDEX BY PART MANUFACTURERS

BENDIX

Cross Ref.	SORL No.	SORL EU No	Page	Cross Ref.	SORL No.	SORL EU No	Page
229635	RL3526HC02	3526 021 002 0	102	279416	RLD5-M027	4101 042 001 0	70
229813	RL3516LA14	3516 018 014 0	115	279692	RL3548ZA02	3548 010 004 0	125
229813	RL3516LB	3516 018 003 0	115	279692	RL3548ZB	3548 010 003 0	125
229844	RL3516LA17	3516 018 017 0	115	279926N	RL3512PA-C	3512 015 009 0	21
229844	RL3516LA-A	3516 018 002 0	115	279946	6031551025	6031551025	332
229859	RL3516LA	3516 018 001 0	115	279947	6031561025	6031561025	332
229859	RL3516LA16	3516 018 016 0	115	279950	RL3514LA	3514 015 000 0	85
229860	RL3516LA15	3516 018 015 0	115	279952	RL3518ED03	3518 005 019 0	130
229860	RL3516LC	3516 018 004 0	115	279952	RL3518EE-A	3518 005 013 0	130
248433	RL3548FD02	3548 006 004 8	241	280375	RL3518EA2	3518 005 006 0	130
248502	RL3548FC02	3548 006 003 8	241	280375	RL3518ED01	3518 005 017 0	130
268597	RL3533JC	3533 007 004 0	216	280479	RL3533GA	3533 004 001 0	215
268597	RL3533JF03	3533 007 010 0	216	280809	RL3533JE	3533 007 006 0	216
275150	RL3521DC	3521 011 002 0	206	280809	RL3533JF01	3533 007 008 0	217
275176	RL3548FA10	3548 006 031 0	230	280904	RL3526GA	3526 011 001 0	102
275200	RL3512GL-K	3512 002 024 0	24	280905	RL3526GB	3526 011 002 0	102
275491	RL3512GL-C	3512 002 018 0	23	280915	RL3512GA-9	3512 002 101 9	25
275508	RL3512GL-H	3512 002 023 0	24	280915	RL3512GB-9	3512 002 102 9	25
275530	RL3512GL-G	3512 002 022 0	24	280915	RL3512GG-9	3512 002 103 9	25
275707	RL3512GL-F	3512 002 021 0	24	281024	RL3516LA18	3516 018 018 0	116
276122	RL3526TA-9	3526 017 001 0-9	105	281024	RL3516LD	3516 018 005 0	116
276270	RL3526TA	3526 017 001 0	101	281459	RL3533EA01	3533 003 007 0	218
276462	RL3548FA41	3548 006 041 0	232	281459	RL3533EA05	3533 003 011 0	218
276566	RL3548FD-D	3548 006 017 0	234	281860	RL3527AB	3527 001 002 0	131
276566	RL3548FD	3548 006 004 0	234	281865	RL3527AD	3527 001 011 0	131
276567	RL3548FD-E	3548 006 018 0	234	281923	RL3513LA	3536 008 001 0	75
276567	RL3548FD-A	3548 006 005 0	234	281946	RL3548EA01	3548 025 001 0	235
276635	RL3526HC04	3526 022 001 0	102	281946	RL3548EA02	3548 025 002 0	235
276635	RL3526HC05	3526 022 002 0	102	282472	RL3533EA03	3533 003 009 0	218
277147	RL3512PA01	3512 015 001 0	21	282472	RL3533ED	3533 003 004 0	218
277147	RL3512PA03	3512 015 003 0	21	282560	6031531025	6031531025	332
277148	RL3512PA07	3512 015 005 0	21	282561	6031541025	6031541025	332
277226N	RL3512PA-A	3512 015 007 0	21	282812	RL3527AB-9	3527 001 002 0-9	137
277227N	RL3512PA-D	3512 015 010 0	21	282812	RL3527AD-9	3527 001 011 0-9	137
277486	RL3512GL-E	3512 002 020 0	24	283411	6020013715	6020013715	331
277863	RL3514PA-A	3514 010 003 0	84	283590	RL3512PA02	3512 015 002 0	21
278288	6031511135	6031511135	332	283590	RL3512PA04	3512 015 004 0	21
278289	6031521135	6031521135	332	283657	RL3512GL-D	3512 002 019 0	23
278294	6031571125	6031571125	332	283700	RL3533EA04	3533 003 010 0	219
278295	6031581125	6031581125	332	283700	RL3533EF	3533 003 005 0	219
278302	6000041125	6000041125	331	283828	RL3548FA08	3548 006 027 0	234
278303	6000031125	6000031125	331	283828	RL3548FA-A	3548 006 012 0	234
278305	6000011135	6000011135	331	283940	RL3518EB-B	3518 005 014 0	130
278321	6000021025	6000021025	331	283940	RL3518ED02	3518 005 018 0	130
278323	6000011035	6000011035	331	284142	RL3513XA02	3513 013 001 0	59
278450	RL3548FA	3548 006 001 0	233	284358	RL3512GL	3512 002 010 0	23
278450	RL3548FA-C	3548 006 014 0	233	286171	RL3514GD-A	3514 007 017 0	84
278523	RL3521DB	3521 011 001 0	206	286364	RL3599EA01	3599 002 001 0	129
278524	RL3521DA	3521 010 001 0	206	286364	RL3599EA02	3599 002 002 0	129
278595	RL3533JA	3533 007 002 0	217	286370	RL3518SS01	3518 029 001 0	148
278595	RL3533JF05	3533 007 012 0	217	286370	RL3518SS04	3518 029 004 0	148
278596	RL3533JB	3533 007 003 0	217	286500	RL3531HA	3531 014 001 0	69
278596	RL3533JF04	3533 007 011 0	217	286500	RL3531HA-A	3531 014 003 0	69
278598	RL3533JD	3533 007 005 0	217	286773	RL3514JA01	3514 017 000 0	87
278598	RL3533JF02	3533 007 009 0	217	286965	6000032825	6000032825	331
278614	RL3533HA	3533 006 001 0	216	287114	RL3518SS02	3518 029 002 0	148
278614	RL3533HA02	3533 006 006 0	216	287114	RL3518SS03	3518 029 003 0	148
278615	RL3533HA01	3533 006 005 0	216	287238	RL3548CA01	3548 028 001 0	235
278615	RL3533HC	3533 006 003 0	216	287238	RL3548CA02	3548 028 002 0	235
278825	RL3533EA02	3533 003 008 0	218	287280	RL3548WC04	3548 019 007 0	233
278825	RL3533EB	3533 003 002 0	218	287376	RL3599AC	3599 001 003 0	127
279000	RL3548ZA	3548 010 001 0	125	287376	RL3599AC-A	3599 001 018 0	127
279000	RL3548ZA01	3548 010 002 0	125	287417	RL3548FA09	3548 006 028 0	234
279180	RL3518ED	3518 005 004 0	131	287417	RL3548FA-B	3548 006 013 0	234

INDEX BY PART MANUFACTURERS

BENDIX				HALDEX			
Cross Ref.	SORL No.	SORL EU No	Page	Cross Ref.	SORL No.	SORL EU No	Page
287600	RL3548FA07	3548 006 026 0	233	12117	255011030007	255011030007	312
288221	RL3518SS04	3518 029 004 0	148	12132	353052833405	353052833405	295
288239	RL3548WD	3548 019 003 0	236	12141	254031021307	254031021307	311
288239	RL3548WD-A	3548 019 004 0	236	12142	255031021307	255031021307	312
288241	RL3548WC	3548 019 001 0	236	12170	231012641007	231012641007	303
288241	RL3548WC-A	3548 019 005 0	236	12171	232012641007	232012641007	303
288251	RL3516LA19	3516 018 019 0	116	12252	888031020507	888031020507	318
288251	RL3516LE	3516 018 006 0	116	12254	254031921355	254031921355	311
288282	6000012835	6000012835	331	12255	255031921355	255031921355	312
288301	RL3522YA04	3522 008 001 0	125	12256	256031920005	256031920005	315
288323	RL3531HC	3531 014 002 0	69	12307	972031020007	972031020007	313
288323	RL3531HC-A	3531 014 004 0	69	12310	986012740707	986012740707	296
288383	RL3514JA03	3514 017 002 0	87	12319	678032830905	678032830905	301
288417	RL3516VA04	3516 060 004 0	118	12320	678032830915	678032830915	301
288417	RL3516VA08	3516 060 008 0	118	123200001	RL3519JA28	3519 030 377 0	249
288605	RL3548RA01	3548 024 001 0	125	12356	888031941287	888031941287	318
288746	RL3548DA01	3548 027 001 0	235	12360	678011031105	678011031105	301
288746	RL3548DA02	3548 027 002 0	235	1351624004	RL3530RB7	3530 451 004 0	277
288753	6000022825	6000022825	331	1362430001	RL3530EY21	3530 120 144 0	283
289144	RL3516WA04	3516 050 008 0	119	1A222822	256032410005	256032410005	316
289144	RL3516WB	3516 050 002 0	119	1A222823	258092413425	258092413425	321
289182	RL3516FD08	3516 006 008 0	117	1A222824	257092413425	257092413425	321
289182	RL3516FE	3516 006 004 0	117	205004001	RL3533MA	3533 010 001 0	215
289329	RL3514PA-9	3514 010 000 0-9	92	314001001	RL3525AA	3525 001 001 0	212
289335	RL3514GD-9	3514 007 002 9-1	92	314012003	RL3531BA-A	3531 002 003 0	60
289714	RL3516FD	3516 006 003 0	116	314013005	RL3531BA	3531 002 001 0	60
289714	RL3516FD07	3516 006 007 0	117	314014004	RL3531BA-B	3531 002 004 0	60
290655	RL3548FD03	3548 006 005 8	241	334025011	RL3521AB	3521 002 001 0	204
295036	RL3533GA	3533 004 001 0	215	334025031	RL3521AG	3521 002 002 0	204
295358	RL3533GC	3533 004 002 0	215	334026011	RL3521AA	3521 001 001 0	203
320100	RL3533KA	3533 008 001 0	215	334026031	RL3521AF	3521 001 002 0	203
800333	RL3516MA	3516 012 001 0	120	338021001	RL8606EA	8606 005 001 0	171
800369	RL3525CC01	3525 015 001 0	213	338050101	RL8606DA	8606 004 001 0	171
800372	RL3525CA04	3525 013 001 0	213	350360011	RL3516YA01	3516 021 001 0	113
800373	RL3525CA05	3525 013 002 0	213	352018001	RL3548QB	3548 012 002 0	236
800376	RL3525CA01	3525 010 001 0	212	352019001	RL3548QA	3548 012 001 0	236
800516	RL3548SA	3548 020 001 0	136	356013011	RL3516TA	3516 015 001 0	118
800629	RL3514YA01	3514 016 007 0	85	400-10141,E6927B	937092833468	937092833468	327
801144	RL3525CC02	3525 015 002 0	213	400-10144,E6918A	922102820665	922102820665	327
802743	RL3516QD01	3516 091 001 0	120	400-10145,E6914	922101020665	922101020665	327
810242	888033721375	888033721375	318	400-10211,E6944	256102820665	256102820665	327
811014	888031021375	888031021375	318	400-10212,E6942	256102820675	256102820675	327
				400-10214,E6946	256103720675	256103720675	327
				400-10215,E6940	256101020665	256101020665	327
				400-10216,E6936	256101020675	256101020675	327
				400-10305	260102831115	260102831115	327
				400-10306	260101031115	260101031115	327
				40010140	273092833468M	273092833468M	323
				40010142	273091033468M	273091033468M	323
				40010143	273091033478M	273091033478M	323
				40010154M1D	273092833478M	273092833478M	323
				40010155	274091033468M	274091033468M	323
				40010213	256103720665	256103720665	316
				40020238M1D	475091030118M	475091030118M	324
				40910551	922092823455	922092823455	307
				40910819	921031011568	921031011568	323
				40910820	920031011568	920031011568	323
				41910822	925102511517	925102511517	320
				41910823	926102511517	926102511517	320
				41910824	986102510108	986102510108	297
				40920044	475091030118	475091030118	293
				4W1235	972121020695	972121020695	314
				4W1235-1	972121020685	972121020685	314
				612032001	RL2908XA01	2908 012 001 0	165
HALDEX							
10274	970021053395	970021053395	309				
10275	971021053395	971021053395	310				
10283	929031921355	929031921355	316				
10284	930031921355	930031921355	316				
10714	970021020005	970021020005	309				
10715	971021020005	971021020005	310				
10868	254031031507	254031031507	311				
10869	255031031507	255031031507	312				
10937	254021030005	254021030005	311				
10938	255021030005	255021030005	312				
11011	678031031507	678031031507	301				
11029	678031031005	678031031005	301				
11031	929031231355	929031231355	316				
11032	930031231355	930031231355	316				
12112	970033721107	970033721107	309				
12113	971033721107	971033721107	310				
12116	254011030007	254011030007	311				

INDEX BY PART MANUFACTURERS

HALDEX

Cross Ref.	SORL No.	SORL EU No	Page	Cross Ref.	SORL No.	SORL EU No	Page
70157	177011930797	177011930797	295	70894	255031050755	255031050755	312
70510	678031051355	678031051355	301	70902	678031021505	678031021505	301
70511	970031051355	970031051355	309	70905	256011030007	256011030007	315
70512	971031051355	971031051355	310	70906	678011060505	678011060505	301
70513	678031031105	678031031105	301	70909	782031020065	782031020065	297
70532	972031061105	972031061105	313	70910	783031020065	783031020065	297
70573	256031070755	256031070755	315	70917	232072630947	232072630947	304
70576	972031020015	972031020015	313	70918	231082630947	231082630947	303
70598	972031030708	972031030708	313	70919	972010830905	972010830905	313
70624	265031071105	265031071105	328	70930	231031050755	231031050755	303
70634	972031061355	972031061355	313	70931	232031050755	232031050755	303
70641	970031040315	970031040315	309	70941	256031041505	256031041505	315
70642	971031040315	971031040315	310	70943	935031061305	935031061305	325
70646	255031040305	255031040305	312	70944	936031061305	936031061305	325
70647	254031040305	254031040305	311	70945	972031060005	972031060005	313
70648	255031040315	255031040315	312	70946	256031041515	256031041515	315
70649	254031040315	254031040315	311	70952	998012631067	998012631067	307
70664	924011030558	924011030558	324	70953	997012631067	997012631067	307
70665	923011030558	923011030558	324	70954	212012630867	212012630867	314
70670	936101031025	936101031025	325	70959	972013721007	972013721007	314
70671	935101031025	935101031025	325	70977	254041053305	254041053305	311
70678	972031021107	972031021107	313	70978	255041053305	255041053305	312
70687	972033740907	972033740907	313	70979	972033740005	972033740005	313
70706	993012630617	993012630617	312	70986	678021051605	678021051605	301
70718	970031920917	970031920917	309	70987	254031061355	254031061355	311
70719	971031920907	971031920907	310	70988	255031061355	255031061355	312
70720	256031920457	256031920457	315	70989	972033741557	972033741557	313
70726	678031941157	678031941157	301	71369	RL3529TA01	3529 003 001 0	17
70740	256031040905	256031040905	315	72001	979011030588	979011030588	308
70752	972011071107	972011071107	313	72005	983032731557	983032731557	317
70753	220022633397	220022633397	304	72006	982032731557	982032731557	317
70754	219022633397	219022633397	304	72011	678031021107	678031021107	301
70762	972011950507	972011950507	313	72012	997012631017	997012631017	307
70764	972011950007	972011950007	313	72013	998012631017	998012631017	307
70771	985022633467	985022633467	306	72014	970031920907	970031920907	309
70772	984022633467	984022633467	306	72015	971031920917	971031920917	310
70775	177012630797	177012630797	295	72016	986031920057	986031920057	296
70781	971031040305	971031040305	310	72019	353051033555	353051033555	295
70782	970031040305	970031040305	309	72021	678031030905	678031030905	301
70787	972031063595	972031063595	313	72021	678031030905	678031030905	301
70801	986041033058	986041033058	296	72027	678031031505	678031031505	301
70802	970031021107	970031021107	309	72028	935031041255	935031041255	325
70803	971031021107	971031021107	310	72029	936031041255	936031041255	325
70804	972011020467	972011020467	313	72030	986031040005	986031040005	296
70823	678031031117	678031031117	301	72031	972031040035	972031040035	313
70824	254031031107	254031031107	311	72036	946012630077	946012630077	327
70825	255031031107	255031031107	312	72037	945012630077	945012630077	327
70840	970031061355	970031061355	309	72038	925012630077	925012630077	320
70841	971031061365	971031061365	310	72039	926012630077	926012630077	320
70842	972031021405	972031021405	314	72053	972011020207	972011020207	314
70851	678011051155	678011051155	301	72056	994022631507	994022631507	306
70854	972013720107	972013720107	314	72059	994012633587	994012633587	306
70858	678031021305	678031021305	301	72060	783022633467	783022633467	297
70859	678031050755	678031050755	301	72061	782022633467	782022633467	297
70864	986041033058	986041033058	296	72062	996022633397	996022633397	319
70867	212022630757	212022630757	314	72063	995022633397	995022633397	319
70871	986031030307	986031030307	296	72066	888031021297	888031021297	318
70878	981041033108	981041033108	305	72069	231012631017	231012631017	303
70879	980041033108	980041033108	305	72070	232012631017	232012631017	303
70882	972031040015	972031040015	313	72085	678031080305	678031080305	301
70886	972031043585	972031043585	313	72086	972031060025	972031060025	313
70887	972031040615	972031040615	314	72089	983032711557	983032711557	317
70891	972010830125	972010830125	314	72090	982032711557	982032711557	317
70893	254031050755	254031050755	311	72099	256012730157	256012730157	315

INDEX BY PART MANUFACTURERS

HALDEX

Cross Ref.	SORL No.	SORL EU No	Page	Cross Ref.	SORL No.	SORL EU No	Page
72100	678012730007	678012730007	302	72313	232011030837	232011030837	303
72103	972031043597	972031043597	313	72318	971012710117	971012710117	310
72107	254021031557	254021031557	311	72319	970012710107	970012710107	309
72108	255021031557	255021031557	312	72320	220022633397	220022633397	304
72114	986051033555	986051033555	296	72321	219022633397	219022633397	304
72115	972031040605	972031040605	314	72322	212022630757	212022630757	314
72117	986021033397	986021033397	296	72326	256011930507	256011930507	316
72140	970031050755	970031050755	309	72327	986011030407	986011030407	296
72141	971031050755	971031050755	310	72328	678012733507	678012733507	302
72143	972031050625	972031050625	314	72333	678031020165	678031020165	302
72144	972021053395	972021053395	314	72334	972031021127	972031021127	313
72145	678031040155	678031040155	301	72344	929021033395	929021033395	316
72147	254031050505	254031050505	311	72345	930021033395	930021033395	316
72148	255031050505	255031050505	312	72346	983012710907	983012710907	317
72149	256021053505	256021053505	315	72347	982012710907	982012710907	317
72150	970021053397	970021053397	309	72348	353012630307	353012630307	295
72152	782031020055	782031020055	297	72353	888031021307	888031021307	318
72153	783031020055	783031020055	297	72362	678031030155	678031030155	301
72160	983012710637	983012710637	317	72363	256031040155	256031040155	315
72161	982012710637	982012710637	318	72364	678021033415	678021033415	302
72162	983062711557	983062711557	317	72367	678031030165	678031030165	302
72163	982062711557	982062711557	317	72368	970031921407	970031921407	309
72166	678041021725	678041021725	302	72369	971031921407	971031921407	310
72173	231012631447	231012631447	303	72370	970051921807	970051921807	309
72174	232012631447	232012631447	304	72371	971051921807	971051921807	310
72177	177011930797	177011930797	295	72372	970032851505	970032851505	309
72178	178022631527	178022631527	308	72373	971032851505	971032851505	310
72180	353052833555	353052833555	295	72376	256032840905	256032840905	315
72181	986052833555	986052833555	296	72393	678031030755	678031030755	301
72182	986011031037	986011031037	296	72403	938051013105	938051013105	325
72189	678031040765	678031040765	301	72404	939051013105	939051013105	325
72190	678031040735	678031040735	301	72405	678011010805	678011010805	302
72195	678011010805	678011010805	302	72406	678011010815	678011010815	302
72197	678021033397	678021033397	302	72407	678011010795	678011010795	302
72198	353051033255	353051033255	295	72408	972011930247	972011930247	314
72199	353052833255	353052833255	295	72416	888031021277	888031021277	318
72202	986021031557	986021031557	296	72417	970021053395	970021053395	309
72203	203011930507	203011930507	298	72418	971021053395	971021053395	310
72204	204011930507	204011930507	298	72419	972060831555	972060831555	313
72208	256012631107	256012631107	315	72425	678031020755	678031020755	301
72211	943022633587	943022633587	299	72430	255032830305	255032830305	312
72212	944022633587	944022633587	300	72431	254032830305	254032830305	311
72213	993022633387	993022633387	312	72438	678012631057	678012631057	302
72234	996022633397	996022633397	319	72441	941012713507	941012713507	326
72235	995022633397	995022633397	319	72448	972031041097	972031041097	313
72236	936101031028	936101031028	325	72452	984031050405	984031050405	306
72237	935101031028	935101031028	325	72454	678031021315	678031021315	302
72246	678031021515	678031021515	301	72455	219012631037	219012631037	304
72247	351011030808	351011030808	294	72456	220012631037	220012631037	304
72248	352011030808	352011030808	294	72457	678031050755	678031050755	301
72249	972031020017	972031020017	313	72467	986051033088	986051033088	296
72250	888031011327	888031011327	318	72468	567011030848	567011030848	305
72252	888033731107	888033731107	318	72469	568011030848	568011030848	305
72253	888031021307	888031021307	318	72476	979011030588	979011030588	308
72254	888031011287	888031011287	318	72477	978011030588	978011030588	308
72261	888031021337	888031021337	318	72482	936011031028	936011031028	325
72263	888031021307	888031021307	318	72483	935011031028	935011031028	325
72271	888031021277	888031021277	318	72487	979011030738	979011030738	308
72278	888031021305	888031021305	318	72488	351011030848	351011030848	294
72303	231062631447	231062631447	303	72489	352011030848	352011030848	294
72304	232062631447	232062631447	304	72491	981051033088	981051033088	305
72308	212022630757	212022630757	314	72492	980051033088	980051033088	305
72309	986011030007	986011030007	296	72499	678031050645	678031050645	302
72312	231011030837	231011030837	303	72508	992012631007	992012631007	319

INDEX BY PART MANUFACTURERS

HALDEX

Cross Ref.	SORL No.	SORL EU No	Page	Cross Ref.	SORL No.	SORL EU No	Page
72509	991012631007	991012631007	319	72645	999031020457	999031020457	322
72512	987142630757	987142630757	320	72660	981051043088	981051043088	305
72513	988142630757	988142630757	320	72661	980051043088	980051043088	305
72515	353012630387	353012630387	295	72662	986051043088	986051043088	296
72517	256031080305	256031080305	315	72663	978011040738	978011040738	308
72518	177011930797	177011930797	295	72664	979011040738	979011040738	308
72519	204011930505	204011930505	298	72665	979011040588	979011040588	308
72520	203011930505	203011930505	298	72666	978011040588	978011040588	308
72521	231051043057	231051043057	303	72667	678031021505	678031021505	301
72523	254021021557	254021021557	311	72677	678031031505	678031031505	301
72524	255021021557	255021021557	312	72678	678041021725	678041021725	302
72525	254021023397	254021023397	311	72688	997011931007	997011931007	307
72526	255021023397	255021023397	312	72689	998011931007	998011931007	307
72527	232012620837	232012620837	303	72695	231011020377	231011020377	303
72530	986021023397	986021023397	296	72696	232011020377	232011020377	303
72532	970021021557	970021021557	309	72697	256031920305	256031920305	315
72533	971021021557	971021021557	310	72698	256031920705	256031920705	315
72534	678021023397	678021023397	302	72702	999031011307	999031011307	322
72535	986021021557	986021021557	296	72703	999031020507	999031020507	322
72538	931011020407	931011020407	298	72709	972061931557	972061931557	313
72539	932011020407	932011020407	298	72710	972011010457	972011010457	313
72540	986021023407	986021023407	296	72723	782031020065	782031020065	297
72541	986011020007	986011020007	296	72724	783031020065	783031020065	297
72544	231011020837	231011020837	303	72725	678031030905	678031030905	301
72545	232011020837	232011020837	303	72725	678031030905	678031030905	301
72547	986011020407	986011020407	296	72726	256041021725	256041021725	316
72550	678021021557	678021021557	302	72727	935011030928	935011030928	325
72554	972031041117	972031041117	313	72728	936011030928	936011030928	325
72558	986051021807	986051021807	296	72729	268011030628	268011030628	329
72561	984022633467	984022633467	306	72730	269011030628	269011030628	329
72562	985022633467	985022633467	306	72731	219012630537	219012630537	304
72563	972031050005	972031050005	313	72732	220012630537	220012630537	304
72575	678031040745	678031040745	301	72733	888030821057	888030821057	318
72578	256012631187	256012631187	315	72735	678011030008	678011030008	302
72579	935011030928	935011030928	325	72738	983012710647	983012710647	317
72580	936011030928	936011030928	325	72739	982012710627	982012710627	318
72583	929022511447	929022511447	316	72740	971012830107	971012830107	311
72584	930022511447	930022511447	316	72741	970012830107	970012830107	310
72585	353022510287	353022510287	295	72745	263041033058	263041033058	329
72586	254021020007	254021020007	311	72746	936101031025	936101031025	325
72587	255021020007	255021020007	312	72747	935101031025	935101031025	325
72591	254031951457	254031951457	311	72758	999033731107	999033731107	322
72592	255031951457	255031951457	312	72763	999031021107	999031021107	322
72593	996022633397	996022633397	319	72772	925061031507	925061031507	320
72594	995022633397	995022633397	319	72773	926061031507	926061031507	320
72596	994012631277	994012631277	306	72777	353011030228	353011030228	295
72608	270021023397	270021023397	328	72778	986011030228	986011030228	296
72610	678032423505	678032423505	302	72779	353011033528	353011033528	295
72613	353012630307	353012630307	295	72782	782031020055	782031020055	297
72614	888012020707	888012020707	318	72783	783031020055	783031020055	297
72616	997012631237	997012631237	307	72784	782031020045	782031020045	297
72617	998012631237	998012631237	307	72785	783031020045	783031020045	297
72620	978011040738	978011040738	308	72786	940012711307	940012711307	326
72621	979011040738	979011040738	308	72787	941012711307	941012711307	326
72624	981051043088	981051043088	305	72788	960111010627	960111010627	322
72625	980051043088	980051043088	305	72798	940012710357	940012710357	326
72626	978011040588	978011040588	308	72799	941012710357	941012710357	326
72627	979011040588	979011040588	308	72805	255031040305	255031040305	312
72630	351011040848	351011040848	294	72806	254031040305	254031040305	311
72631	352011040848	352011040848	294	72807	923011040558	923011040558	324
72633	971012711257	971012711257	311	72808	924011040558	924011040558	324
72634	970012711257	970012711257	309	72809	219012631037	219012631037	304
72643	678021031555	678021031555	302	72810	220012631037	220012631037	304
72644	678021033405	678021033405	302	72811	219012630537	219012630537	304

INDEX BY PART MANUFACTURERS

HALDEX

Cross Ref.	SORL No.	SORL EU No	Page	Cross Ref.	SORL No.	SORL EU No	Page
72812	220012630537	220012630537	304	72966	998012631017	998012631017	307
72813	940012711057	940012711057	326	72967	256012631107	256012631107	315
72814	941012711057	941012711057	326	72968	231062631447	231062631447	303
72815	254031050757	254031050757	311	72969	232062631447	232062631447	304
72816	255031050757	255031050757	312	72971	219022633397	219022633397	304
72818	929011210685	929011210685	316	72972	212022630757	212022630757	314
72819	930011210685	930011210685	316	72972	212022630757	212022630757	314
72820	986011410525	986011410525	296	72975	353012630307	353012630307	295
72825	351011040848	351011040848	294	72980	678012631057	678012631057	302
72826	352011040848	352011040848	294	72981	219012631037	219012631037	304
72835	970012710117	970012710117	309	72982	220012631037	220012631037	304
72836	971012710107	971012710107	310	72985	992012631007	992012631007	319
72837	986011010637	986011010637	297	72986	991012631007	991012631007	319
72838	983012711357	983012711357	317	72987	987142630757	987142630757	320
72839	982012711357	982012711357	317	72988	988142630757	988142630757	320
72840	972012711037	972012711037	314	72989	256012631187	256012631187	315
72851	927011040628	927011040628	321	72990	219012630537	219012630537	304
72852	928011040628	928011040628	321	72991	220012630537	220012630537	304
72854	946011930077	946011930077	327	72993	940012713507	940012713507	326
72855	945011930077	945011930077	327	72994	941012713507	941012713507	326
72856	929012531308	929012531308	316	72995	927011041408	927011041408	321
72857	930012531308	930012531308	316	72997	970012833507	970012833507	310
72858	256012530408	256012530408	315	72998	971012833507	971012833507	311
72861	999033620507	999033620507	322	78964	RL3513EF01	3513 500 001 0	41
72862	986051023027	986051023027	297	78990	RL3511HD01	3511 029 001 0	37
72863	888031011337	888031011337	318	79000	970012713517	970012713517	310
72864	986052833405	986052833405	297	79001	971012713517	971012713517	311
72865	256012631357	256012631357	315	79002	231012643557	231012643557	303
72871	999030811307	999030811307	322	79003	232012643557	232012643557	303
72872	994011931037	994011931037	306	79005	999111011307	999111011307	322
72875	999111020507	999111020507	322	79007	983032731557	983032731557	317
72876	999111021107	999111021107	322	79008	982032731557	982032731557	317
72883	999031021507	999031021507	322	79009	983032711557	983032711557	317
72888	888012020707	888012020707	318	79010	982032711557	982032711557	317
72889	999031011507	999031011507	322	79011	256012730157	256012730157	315
72892	568011030848	568011030848	305	79012	678012730007	678012730007	302
72893	567011030848	567011030848	305	79013	983012710637	983012710637	317
72904	971031040305	971031040305	310	79014	982012710637	982012710637	318
72905	256031040905	256031040905	315	79015	983062711557	983062711557	317
72910	678041033058	678041033058	301	79016	982062711557	982062711557	317
72911	255031040315	255031040315	312	79017	971012710117	971012710117	310
72912	254031040315	254031040315	311	79018	970012710107	970012710107	309
72914	970031040305	970031040305	309	79019	678012733507	678012733507	302
72917	254031021107	254031021107	311	79020	983012710907	983012710907	317
72918	255031021107	255031021107	312	79021	982012710907	982012710907	317
72919	231012630307	231012630307	303	79028	970061021457	970061021457	309
72920	232012630307	232012630307	303	79029	971061021457	971061021457	311
72928	972032021357	972032021357	314	79033	927011040848	927011040848	321
72929	351061931427	351061931427	294	79034	928011040848	928011040848	321
72930	261011931205	261011931205	328	79036	995022633497	995022633497	319
72935	678011020305	678011020305	302	79037	996022633497	996022633497	319
72937	231012631017	231012631017	303	79040	970031951407	970031951407	309
72938	232012631017	232012631017	303	79041	971031951407	971031951407	310
72940	231012640437	231012640437	303	79043	970061011447	970061011447	309
72941	232012640437	232012640437	303	79044	971061011447	971061011447	310
72947	986041033058	986041033058	296	79056	972032030757	972032030757	314
72948	888111011307	888111011307	318	79062	678031050665	678031050665	302
72949	981041033108	981041033108	305	79067	888021020007	888021020007	318
72950	980041033108	980041033108	305	79070	986011210005	986011210005	296
72956	936101031028	936101031028	325	79071	972021050635	972021050635	314
72957	935101031028	935101031028	325	79072	678031020605	678031020605	302
72963	986041033058	986041033058	296	79073	997012630167	997012630167	307
72965	997012631017	997012631017	307	79074	998012630167	998012630167	307
72996	928011041408	928011041408	321	79075	940062711467	940062711467	326

INDEX BY PART MANUFACTURERS

HALDEX

Cross Ref.	SORL No.	SORL EU No	Page	Cross Ref.	SORL No.	SORL EU No	Page
79076	941062711467	941062711467	326	79227	256012631187	256012631187	315
79077	940062711457	940062711457	326	79228	219012630537	219012630537	304
79078	941062711457	941062711457	326	79229	220012630537	220012630537	304
79079	986032030417	986032030417	296	79230	678031921207	678031921207	302
79080	986052833087	986052833087	297	79231	231021931157	231021931157	303
79082	972052833255	972052833255	314	79232	232021931157	232021931157	304
79090	972031010127	972031010127	314	79233	678030821207	678030821207	302
79096	986011410005	986011410005	296	79234	256010820757	256010820757	316
79097	266061021457	266061021457	329	79235	960111010627	960111010627	322
79099	231012630007	231012630007	303	79236	970031941407	970031941407	309
79100	232012630007	232012630007	303	79237	971031941407	971031941407	310
79103	678012530905	678012530905	302	79245	927032040907	927032040907	321
79104	972022510055	972022510055	314	79246	928032040907	928032040907	321
79105	923011040558	923011040558	324	79247	986032833428	986032833428	297
79106	924011040558	924011040558	324	79250	934012530058	934012530058	299
79107	231032020907	231032020907	303	79251	933012530058	933012530058	299
79108	232032020907	232032020907	303	79255	972022550907	972022550907	313
79109	999111010607	999111010607	322	79256	983062711567	983062711567	317
79111	999110820607	999110820607	322	79257	982062711567	982062711567	317
79112	999111020607	999111020607	322	79258	970011031207	970011031207	310
79117	986011023525	986011023525	296	79259	971011031207	971011031207	310
79124	983012730637	983012730637	317	79267	678032830005	678032830005	302
79125	982012730637	982012730637	318	79275	979041033345	979041033345	308
79128	177051032706	177051032706	295	79271	678031021515	678031021515	301
79136	998012631557	998012631557	307	79276	978041033345	978041033345	308
79137	997012631557	997012631557	307	79286	983012710647	983012710647	317
79142	970061011277	970061011277	309	79287	982012710627	982012710627	318
79143	971061011287	971061011287	311	79288	971012830107	971012830107	311
79149	999111021307	999111021307	322	79289	970012830107	970012830107	310
79153	968032711007	968032711007	298	79294	940012710357	940012710357	326
79154	351012831408	351012831408	294	79295	941012710357	941012710357	326
79155	352012830408	352012830408	294	79296	940012711057	940012711057	326
79156	970021051555	970021051555	309	79297	941012711057	941012711057	326
79157	971021051555	971021051555	310	79299	970012710117	970012710117	309
79158	254021053395	254021053395	311	79300	971012710107	971012710107	310
79159	255021053395	255021053395	312	79301	983012711357	983012711357	317
79160	999031021307	999031021307	322	79302	982012711357	982012711357	317
79161	986051021755	986051021755	297	79303	972012711037	972012711037	314
79167	923011020707	923011020707	324	79304	970012833507	970012833507	310
79168	924011020707	924011020707	324	79305	971012833507	971012833507	311
79169	256031040015	256031040015	315	79306	970012713517	970012713517	310
79177	986032830305	986032830305	296	79307	971012713517	971012713517	311
79184	353022830755	353022830755	295	79310	940062711457	940062711457	326
79185	994012631147	994012631147	306	79311	941062711457	941062711457	326
79186	942022631507	942022631507	299	79312	983012730637	983012730637	317
79202	353012630387	353012630387	295	79313	982012730637	982012730637	318
79203	984022633467	984022633467	306	79321	888031011327	888031011327	318
79204	985022633467	985022633467	306	79325	999031020457	999031020457	322
79205	997012631017	997012631017	307	79326	999031011307	999031011307	322
79206	998012631017	998012631017	307	79327	999031020507	999031020507	322
79207	256012631107	256012631107	315	79328	972011010457	972011010457	313
79208	231062631447	231062631447	303	79329	986021013527	986021013527	296
79209	232062631447	232062631447	304	79331	999111011307	999111011307	322
79210	220022633397	220022633397	304	79336	970061011447	970061011447	309
79211	219022633397	219022633397	304	79337	971061011447	971061011447	310
79212	212022630757	212022630757	314	79342	972031010127	972031010127	314
79215	353012630307	353012630307	295	79346	999111031307	999111031307	322
79218	678012631057	678012631057	302	79349	979061040437	979061040437	308
79219	219012631037	219012631037	304	79350	978061040437	978061040437	308
79220	220012631037	220012631037	304	79351	351031421306	351031421306	294
79223	992012631007	992012631007	319	79352	352031421306	352031421306	294
79224	991012631007	991012631007	319	79353	353031410146	353031410146	295
79225	987142630757	987142630757	320	79354	678031410496	678031410496	302
79226	988142630757	988142630757	320	79377	929012621137	929012621137	316

INDEX BY PART MANUFACTURERS

HALDEX

Cross Ref.	SORL No.	SORL EU No	Page	Cross Ref.	SORL No.	SORL EU No	Page
79378	930012621137	930012621137	316	79541	972022521445	972022521445	314
79390	986032020257	986032020257	297	79543	972022520565	972022520565	314
79396	923012643557	923012643557	324	79544	972022530035	972022530035	314
79397	924012643557	924012643557	324	79545	972022520035	972022520035	314
79411	678032430905	678032430905	302	79546	987012810857	987012810857	320
79412	929032530408	929032530408	316	79547	988012810857	988012810857	320
79413	930032530408	930032530408	316	79548	678012810107	678012810107	302
79414	929032531308	929032531308	316	79550	927011041408	927011041408	321
79415	930032531308	930032531308	316	79551	928011041408	928011041408	321
79416	256032530408	256032530408	315	79552	999111011317	999111011317	322
79417	934032530058	934032530058	299	79553	256031420005	256031420005	315
79418	933032530058	933032530058	299	79557	986011033528	986011033528	296
79419	986011010457	986011010457	297	79562	994031030206	994031030206	306
79422	929011930905	929011930905	316	79564	678031020605	678031020605	302
79423	930011930905	930011930905	316	79567	567031020906	567031020906	305
79427	972031420705	972031420705	313	79568	568031020906	568031020906	305
79428	986051021755	986051021755	297	79569	678011020286	678011020286	302
79429	203011930507	203011930507	298	79571	678011021506	678011021506	301
79430	204011930507	204011930507	298	79572	995022633397	995022633397	319
79434	929031241355	929031241355	316	79573	996022633397	996022633397	319
79435	930031241355	930031241355	316	79574	972011021277	972011021277	314
79436	256031420705	256031420705	315	79575	567011020206	567011020206	305
79437	256021430655	256021430655	315	79576	568011020206	568011020206	305
79440	940012713507	940012713507	326	79577	923011021207	923011021207	324
79442	927011040848	927011040848	321	79578	924011021207	924011021207	324
79443	928011040848	928011040848	321	79595	972011031277	972011031277	314
79444	972061011277	972061011277	314	79599	970021053405	970021053405	309
79449	970061011287	970061011287	310	79600	971021053405	971021053405	310
79450	971061011277	971061011277	311	79606	987012630947	987012630947	320
79460	256031430005	256031430005	315	79607	988012630947	988012630947	320
79461	986022830755	986022830755	297	79608	994012631057	994012631057	306
79462	351061931427	351061931427	294	79617	678031030406	678031030406	302
79464	353031020555	353031020555	295	79618	678031021306	678031021306	302
79465	970012733507	970012733507	310	79619	999111010617	999111010617	322
79466	971012733507	971012733507	310	79626	972022520907	972022520907	313
79467	254011020967	254011020967	311	79627	678011020706	678011020706	302
79468	255011020967	255011020967	312	79636	219031061006	219031061006	304
79469	256010821477	256010821477	316	79637	931011930507	931011930507	298
79480	929032511308	929032511308	316	79638	932011930507	932011930507	298
79481	930032531308	930032531308	316	79646	678011020366	678011020366	302
79483	970031030307	970031030307	309	79647	678032431305	678032431305	302
79484	971031030307	971031030307	310	79648	986032433525	986032433525	296
79487	256011020517	256011020517	316	79649	999111021117	999111021117	322
79490	256031440005	256031440005	315	79650	983011030637	983011030637	317
79493	254021430655	254021430655	311	79651	982011030637	982011030637	318
79494	255021430655	255021430655	312	79652	972022530237	972022530237	314
79495	970061011437	970061011437	309	79656	994022630077	994022630077	306
79496	971061011437	971061011437	310	79659	929022531447	929022531447	316
79502	972011020207	972011020207	314	79660	930022531447	930022531447	316
79510	970032630357	970032630357	310	79661	986022533537	986022533537	297
79511	971032630357	971032630357	310	79662	923012641017	923012641017	324
79514	231062631447	231062631447	303	79663	924012641017	924012641017	324
79515	232062631447	232062631447	304	79677	979041033345	979041033345	308
79516	256031420005	256031420005	315	79678	978041033345	978041033345	308
79517	678021020906	678021020906	302	79682	986052833557	986052833557	296
79525	983012711007	983012711007	317	79683	970012733507	970012733507	310
79526	982012711007	982012711007	318	79684	971012733507	971012733507	310
79532	972031930705	972031930705	313	79685	972111020605	972111020605	314
79533	972031440005	972031440005	313	79695	256012631357	256012631357	315
79535	983062711567	983062711567	317	79735	972031080305	972031080305	314
79536	982062711567	982062711567	317	79759	930032531308	930032531308	316
79537	970011930007	970011930007	309	80000	493012631507	493012631507	289
79538	971011930007	971011930007	310	80001	492012631507	492012631507	289
79539	678011920907	678011920907	302	80008	494022631507	494022631507	289

INDEX BY PART MANUFACTURERS

HALDEX

Cross Ref.	SORL No.	SORL EU No	Page	Cross Ref.	SORL No.	SORL EU No	Page
80009	495022631507	495022631507	289	80166	495022611507	495022611507	289
80010	491012631507	491012631507	290	80176	493012631507	493012631507	289
80011	490012631507	490012631507	290	80177	492012631507	492012631507	289
80012	474012630117	474012630117	290	80178	494022631507	494022631507	289
80013	473012630117	473012630117	290	80179	495022631507	495022631507	289
80014	488012630117	488012630117	290	80180	491012631507	491012631507	290
80018	498111030817	498111030817	291	80181	490012631507	490012631507	290
80019	498111020117	498111020117	291	80183	488012630217	488012630217	290
80020	498111010217	498111010217	291	80200	475102430217	475102430217	293
80021	498113710317	498113710317	291	80300	497102511507	497102511507	294
80022	498111010417	498111010417	291	80301	496102511507	496102511507	294
80023	498111010317	498111010317	291	80348	497102531507	497102531507	294
80024	498111010517	498111010517	291	80349	496102531507	496102531507	294
80025	498102831016	498102831016	291	82361	678031050655	678031050655	302
80031	498102811116	498102811116	291	90054007	RL2908EA	2908 005 001 0	166
80032	498111010615	498111010615	291	90054007	RL2908EB	2908 005 002 0	166
80033	498103731417	498103731417	291	90554107	RL3531UB01	3531 021 001 0	69
80034	487112830215	487112830215	292	90554241	RL2908KA	2908 010 001 0	167
80035	487112830318	487112830318	292	90554243	RL2908KB	2908 010 002 0	167
80037	498113710615	498113710615	291	90554615	RL1705JD01	1705 072 001 0	225
80039	494011031507	494011031507	289	92528	RL3513EF01	3513 500 001 0	41
80040	495011031507	495011031507	289	93522	RL3513EF01	3513 500 001 0	41
80041	498111030817	498111030817	291	950364047	RL3518ZM-A	3518 020 021 0	157
80042	498032030917	498032030917	291	950364104	RL3527KA	3527 007 001 0	134
80045	487091030115	487091030115	292	A72420	RL3529DA	3511 002 001 0	17
80061	487032530418	487032530418	292	E6923B	937091023468	937091023468	327
80067	498111010717	498111010717	291	E6924B	937091033468	937091033468	327
80069	487102410515	487102410515	292	E6925B	937092823468	937092823468	327
80070	472102410115	472102410115	291				
80071	471102410115	471102410115	291				
80072	487092410515	487092410515	292	KNORR BREMSE			
80073	486092410115	486092410115	292	0481009029000	RL3531GB16	3531 010 016 0	61
80074	485092410115	485092410115	292	0481009047000	RL3531GA10	3531 010 010 0	60
80075	487092410505	487092410505	292	0481009102000	RL3531GG	3531 010 007 0	61
80076	486032410115	486032410115	292	0481026303000	RL3518AD01	3518 036 001 0	142
80077	485032410115	485032410115	292	0481039221000	RL3512NA	3512 014 001 0	19
80078	498112630817	498112630817	291	0481063004000	RL3531ZA	3531 012 001 0	64
80082	498111021215	498111021215	291	0481064603000	RL3514SA	3514 014 000 0	88
80084	493012631507	493012631507	289	0484210001000	RL3754EL03	3754 045 003 0	42
80085	492012631507	492012631507	289	0500005001000	RL2908MA02	2908 015 002 0	168
80086	488012630217	488012630217	290	0500005002000	RL2908MA01	2908 015 001 0	167
80087	494022631507	494022631507	289	0501100029000	RL3754EL05	3754 045 005 0	178
80088	495022631507	495022631507	289	0501100031000	RL3754EL01	3754 045 001 0	177
80089	487031030115	487031030115	292	0501100041000	RL3754EL02	3754 045 002 0	178
80092	491012631507	491012631507	290	0501100052000	RL3754EL04	3754 045 004 0	178
80093	490012631507	490012631507	290	0504002114000	RL2908MC	2908 016 002 0	179
80094	487032830515	487032830515	292	076620102000	RL3514HE-9	3514 008 004 9	92
80095	487012530418	487012530418	292	076620102000	RL3514HE-A-9	3514 008 010 9	92
80106	472032410115	472032410115	291	076620102000	RL3514HE-B-9	3514 008 0110-9	92
80107	471032410115	471032410115	291	1023275000	RL3514CB	3514 003 002 0	83
80108	498111011517	498111011517	291	1189392000	RL3512GA	3512 002 001 0	22
80109	487031020515	487031020515	292	1189393000	RL3512GB	3512 002 002 0	22
80124	476011010117	476011010117	293	263243700155	RL3515XA02	3515 018 002 0	54
80125	477011010117	477011010117	293	313002	RL3529BA	3511 010 001 0	43
80126	498111011717	498111011717	291	4751300115R	RL3509AZ-E	3509 055 001 0	2
80129	476011010217	476011010217	293	481009017	RL3531GB	3531 010 002 0	61
80130	477011010217	477011010217	293	622190AM	RL1608XC	1608 050 003 0	181
80133	498111011317	498111011317	291	622199AM	RL1608XD	1608 050 002 0	182
80134	498061011617	498061011617	291	622508AM	RL1608XC01	1608 050 004 0	181
80136	478011010117	478011010117	293	622785AM	RL1608XA	1608 049 001 0	181
80150	487032830517	487032830517	292	625218AM	RL1608XA-9	1608 049 001 0-9	194
80163	493012611507	493012611507	289	626392AM	RL1608VA03	1608 058 003 0	181
80164	492012611507	492012611507	289	627805AM	RL1608XC02	1608 050 014 0	182
80165	494022611507	494022611507	289	629683AM	RL1604AA03	1604 001 003 0	182

INDEX BY PART MANUFACTURERS

KNORR BREMSE

Cross Ref.	SORL No.	SORL EU No	Page	Cross Ref.	SORL No.	SORL EU No	Page
AC152DX	RL3531VA01	3531 028 001 0	61	DPM64MP	RL3526XD01	3526 043 001 0	98
AC574AXY	RL3518SK02	3518 031 002 0	149	DPM94AAX	RL3526NE	3526 006 005 0	98
AC574BYW	RL3518SK01	3518 031 001 0	149	DPM95AAX	RL3526NE-A	3526 006 008 0	98
AC577A	RL3518AC01	3518 035 001 0	143	DR3200	RL3512PA06	3512 018 001 0	18
AC596A	RL3522YC01	3522 010 001 0	123	DR3500	RL3512CB	3512 008 001 0	20
AC598C	RL3522YC02	3522 010 002 0	123	DX70C	RL3514HG	3514 008 006 0	86
AE1103	RL2908YA02	2908 011 002 0	168	DX75BA	RL3514HE	3514 008 004 0	86
AE1122	RL2908YA01	2908 011 001 0	168	DX75BAY	RL3514HE-A	3514 008 010 0	86
AE1124	RL8606FA01	8606 007 001 0	171	DX80D	RL3514HB23	3514 008 023 0	79
AE4158	RL3515LF	3515 007 029 0	46	DX80E	RL3514HB21	3514 008 021 0	79
AE4162	RL3515CA	3515 001 001 0	46	DX95B	RL3514HE-B	3514 008 011 0	86
AE4168	RL3515LF-A	3515 007 030 0	46	EE4106	RL3513GC	3536 009 004 0	75
AE4170	RL3515LF06	3515 007 103 0	47	HB1142	RL3526QL02	3526 030 002 0	100
AE4170	RL3515LF-B	3515 007 031 0	46	HB1219	RL3526WL01	3526 028 001 0	100
AE4178	RL3515LA05	3515 007 005 0	47	HB1242	RL3526QL01	3526 030 001 0	100
AE4179	RL3515LF-F	3515 007 047 0	47	I69783	RL2908YA01-9	2908 011 001 0-9	170
AE4404	RL3515QA02	3515 016 007 0	48	I69783	RL2908YA02-9	2908 011 002 0-9	170
AE4412	RL3515LA15	3515 007 115 0	47	I72375	RL3514CA-9	3514 003 000 0-9	92
AE4422	RL3515QA05	3515 016 011 0	48	I72375	RL3514CA-9	3514 003 000 0-9	92
AE4427	RL3515LF-D	3515 007 042 0	46	I74651	RL2908DA-9	2908 004 001 0-9	169
AE4428	RL3515LF-E	3515 007 043 0	47	I81171	RL3515CA-9	3515 001 001 0-9	58
AE4437	RL3515QA04	3515 016 012 0	48	I81171	RL3515LF-9	3515 007 001 9	58
AE4440	RL3515TA03	3515 012 003 0	48	I81171	RL3515LF-A-9	3515 007 030 0-9	58
AE4443	RL3515LA17	3515 007 117 0	48	I81171	RL3515LF-B-9	3515 007 031 0-9	58
AE4448	RL3515CA05	3515 001 005 0	46	I83121	RL3514HA-9	3514 008 000 0-9	92
AE4452	RL3515CA06	3515 001 006 0	46	I83121	RL3514HB-9	3514 008 001 0-9	92
AE4502	RL3515AH03	3515 023 003 0	56	I84613	RL1608CA-9	1608 023 002 9	196
AE4505	RL3515AH01	3515 023 001 0	56	I86534	RL2908BA-9	2908 002 001 0-9	169
AE4510	RL3515AH02	3515 023 002 0	56	I86534	RL2908BB-9	2908 002 002 0-9	169
AE4525	RL3515AH07	3515 023 007 0	56	I86534	RL2908CA-9	2908 003 001 0-9	169
AE4526	RL3515AH08	3515 023 008 0	56	I86534	RL2908CB-9	2908 003 002 0-9	169
AE4527	RL3515AH09	3515 023 009 0	56	I87546	RL3512CB-9	3512 008 002 0-9	25
AE4528	RL3515AH10	3515 023 010 0	57	I88770R	RL3509AD-A	3509 004 002 0	1
AE4529	RL3515AH11	3515 023 011 0	57	I90265	RL3509AN	3509 014 001 0	1
AE4534	RL3515AH12	3515 023 012 0	57	II14195008	RL1608LA-9	1608 040 001 0-9	195
AE4604	RL3515XA01	3515 018 001 0	53	II15126	RL3509AN-A	3509 014 002 0	1
AE4605	RL3515XD01	3515 026 001 0	48	II15140	RL3509CD	3509 005 003 0	3
AE4608	RL3515XA09	3515 018 009 0	54	II159920065	3509 028 005 1	3509 028 005 1	13
AE4611	RL3515XA10	3515 018 010 0	54	Similar with II31323006-1	RL3509AD-A-9	3509 004 002 9	7
AE4612	RL3515XA11	3515 018 011 0	54	Similar with II31323006-1	RL3509AD-A-9	3509 004 002 9	7
AE4613	RL3515XA12	3515 018 012 0	54	Similar with II31323006-1	RL3509AN-9	3509 014 001 9	8
AE4615	RL3515XA07	3515 018 007 0	54	II31343	RL3509AN-B	3509 014 003 0	2
AE4641	RL3515XA13	3515 018 013 0	54	II32715	RL3530CB24	3530 060 912 0	262
AE4642	RL3515XA14	3515 018 014 0	55	II35564	RL3509DH	3509 030 001 0	4
AE4643	RL3515XA15	3515 018 015 0	55	II36302	RL3514XA01	3514 019 001 0	87
AE4644	RL3515XA16	3515 018 016 0	55	II36928R	RL3509CC	3509 005 002 0	3
AE4645	RL3515XA17	3515 018 017 0	55	II38201	RL3512CB02	3512 008 002 0	20
AE4646	RL3515XA18	3515 018 018 0	55	K001119V	RL3509DJ	3509 036 001 0	3
AE4648	RL3515XA19	3515 018 019 0	55	K001242	RL3515QA01	3515 016 001 0	48
AE4800	RL3515AE01	3515 020 001 0	57	K001330	RL3509AN-D	3509 014 005 0	2
BS3300	RL3519HA24	3519 210 124 0	243	K001726	RL3526XE01	3526 044 001 0	101
BS8500	RL3530MS01	3530 840 001 0	263	K007254	RL3509BH	3509 028 001 0	4
Alternative BS8508	RL3530CB02	3530 060 838 0	262	K010108A	RL3548BA01	3548 033 001 0	233
Alternative BS8508	RL3530CB01	3530 061 048 0	262	K010108B1	RL3548BA02	3548 033 002 0	233
Alternative BS9397	RL3530QB6	3530 420 233 0	262	K013741N00	RL2908MB	2908 016 001 0	179
Alternative BY9401	RL3530PP04	3530 390 166 0	262	K016615KT	RL3509DH-A	3509 031 001 0	4
Alternative BS9404	RL3530PE77	3530 390 178 0	262	K01920	RL3509BH-9	3509 028 001 9	13
Alternative BS9404	RL3530PP02	3530 390 156 0	262	KA625559	RL1608XC03	1608 050 017 0	182
BS9404	RL3530PP03	3530 390 171 0	262	KB2725	948021021437	948021021437	300
BS9503	RL3530CB06	3530 061 026 0	262	KB2730	947021021437	947021021437	300
Alternative BS9520	RL3530CB04	3530 060 999 0	262	KB6540	488012630117	488012630117	290
BS9520	RL3530CB07	3530 061 027 0	262	KN0481500101	RL8606JC	8606 013 001 0	211
BX9503	RL3530CB24	3530 060 912 0	262	KW4648/1	RL3525GA	3525 007 001 0	214
DPM28A	RL3526NE-B	3526 006 043 0	98	KX175/1	RL3513HA	3513 008 001 0	59

INDEX BY PART MANUFACTURERS

KNORR BREMSE

Cross Ref.	SORL No.	SORL EU No	Page
KZ433.1	RL3509BE	3509 051 001 0	4
KZ642.1	RL3509BE	3509 051 001 0	4
LA1100	RL3529AA	3511 011 001 0	43
LA6200	RL3511CH-A	3511 005 006 0	32
LA6210	RL3511CH	3511 005 005 0	32
LA6734	RL3511NB02	3511 014 002 0	33
LA8003	RL3511NA17	3511 014 035 0	33
LA8004	RL3511NA18	3511 014 036 0	34
LA8008	RL3511NA02	3511 014 005 0	33
LA8011	RL3511NA19	3511 014 037 0	34
LA8016	RL3511NA20	3511 014 038 0	34
LA8027	RL3511NA21	3511 014 039 0	34
LA8028	RL3511NA22	3511 014 040 0	34
LA8040	RL3511NA23	3511 014 041 0	34
LA8044	RL3511NA24	3511 014 042 0	34
LA8050	RL3511NA25	3511 014 043 0	34
LA8057	RL3511NA26	3511 014 044 0	35
LA8060	RL3511NA27	3511 014 045 0	35
LA8062	RL3511NA28	3511 014 046 0	35
LA8063	RL3511NA29	3511 014 047 0	35
LA8064	RL3511NA30	3511 014 048 0	35
LA8065	RL3511NA16	3511 014 033 0	33
LA8125	RL3511XB05	3511 027 002 0	36
LA8210	RL3511NA12	3511 014 028 0	33
LA8211	RL3511NA07	3511 014 012 0	33
LA8234	RL3511NA08	3511 014 008 0	33
LA8523	RL3511NA01	3511 014 004 0	33
LA9010	RL3511XB03	3511 020 003 0	36
LA9020	RL3511XB02	3511 020 002 0	36
Similar With LK1303	RL3509AA-9	3509 001 001 9	6
LK1314	RL3509AD	3509 004 001 0	1
LK4936	RL3509DJ-A	3509 037 001 0	5
MB4434	RL3514CA	3514 003 000 0	83
MB4611	RL3514HB17	3514 008 017 0	85
MB4613	RL3514HB18	3514 008 018 0	85
MB4629	RL3514HA	3514 008 000 0	85
MB4630	RL3514HB	3514 008 001 0	85
MB4636	RL3514HH	3514 008 007 0	86
MB4690	RL3514HD	3514 008 003 0	86
MB4694	RL3514HC	3514 008 002 0	86
MB4815	RL3514XA01	3514 019 001 0	87
MB4820	RL3514XA04	3514 019 004 0	87
MB4821	RL3514XA03	3514 019 003 0	87
MB4852	RL3514HB22	3514 008 022 0	85
SEB22267	RL3514CB-9	3514 003 002 0-9	91
SV1280	RL2908DA	2908 004 001 0	164
SV1281	RL2908DA05	2908 004 005 0	165
SV1294	RL2908BA	2908 002 001 0	164
SV1295	RL2908CA	2908 003 001 0	164
SV1310	RL2908BB	2908 002 002 0	164
SV1318	RL2908CB	2908 003 002 0	164
SV1361	RL2908BB-A	2908 002 003 0	164
SV3111	RL8606GA	8606 008 001 0	171
SV3115	RL8606GB	8606 008 002 0	171
SV3302	RL1705WA	1705 050 001 0	226
SV3336	RL1705JC01	1705 062 001 0	228
SV3360	RL1705YA	1705 052 001 0	226
SV3367	RL1705ZA	1705 053 001 0	226
SV3371	RL1705XA	1705 051 001 0	226
SZ1114	RL2135DA	2135 004 001 0	219
SZ1115	RL2135EA	2135 005 001 0	219
SZ1159	RL2135EB	2135 005 002 0	220
VG3200	RL1608CA	1608 023 001 0	192
VG3361	RL1608LA	1608 040 001 0	186

Cross Ref.	SORL No.	SORL EU No	Page
ZB4587	RL3511XB04	3511 027 001 0	26
ZB4805	RL3511XB01	3511 020 001 0	26
MIDLAND			
KN12352	RL3527MA	3527 008 000 0	134
KN12352	RL3527MA02	3527 008 002 0	134
KN20021	RL3548FH	3548 006 007 0	233
KN20022	RL3548FH-A	3548 006 009 0	233
KN20031	RL3548YB-A	3548 011 004 0	237
KN20033	RL3548YB	3548 011 003 0	237
KN20903	RL3548FH317	3548 006 020 3	241
KN23000	RL3525ZA	3525 006 001 0	212
KN23010	RL3525ZB	3525 006 002 0	213
KN23040	RL3525ZA05	3525 006 005 0	213
KN24000	RL3536ZA02	3536 011 002 0	76
KN24001	RL3536ZA01	3536 011 001 0	76
KN26000	RL3527GC	3527 006 004 0	125
KN26000	RL3527GC01	3527 006 009 0	125
KN28060	RL3518TA-A	3518 016 002 0	150
KN28071	RL3518TC	3518 016 020 0	150
KN28071	RL3518TC01	3518 016 023 0	150
KN28080	RL3518TB	3518 016 010 0	150
KN28080	RL3518TC02	3518 016 024 0	150
KN28300	RL3518TA	3518 016 001 0	150
KN28500	RL3518GB	3518 007 018 0	142
KN28510	RL3518GG	3518 007 013 0	143
KN28520	RL3518GH	3518 007 023 0	143
KN28531	RL3518GG-A	3518 007 029 0	143
KN30100	RL3518LE-A	3518 010 001 0	149
KN30200	RL3518LE-B	3518 010 002 0	149
KN30300	RL3518LE-D	3518 010 004 0	149
KN30400	RL3518LE-C	3518 010 003 0	149
KN31000	RL3531UA01	3531 017 001 0	68
KN32010	RL3516JA	3516 010 001 0	119
KN44041	6020013715	6020013715	331
KN44042	6000013735	6000013735	331
KN44051	6000032825	6000032825	331
KN44061	6000022825	6000022825	331
KN47001	6000011035	6000011035	331
KN47011	6000021025	6000021025	331
KN48001	6000031125	6000031125	331
KN48002	6000011135	6000011135	331
KN48031	6000041125	6000041125	331
KN55001	6020022415	6020022415	331
RKN34030	RL3522NA02	3522 007 002 0	124
RKN34030	RL3522NA04	3522 007 004 0	124
RKN34050	RL3522NA01	3522 007 001 0	123
RKN34050	RL3522NA03	3522 007 003 0	124
RKN34060	RL3522UA01	3522 006 001 0	124
RKN34060	RL3522UA02	3522 006 002 0	124
WABCO			
1642176708	RL1608ZA01	1608 057 001 0	183
4005000810 w/o 4461080850	RL3518SU01	3518 030 001 0	156
4110345010	RL3509AA	3509 001 001 0	1
4111476034	3509 003 008 1	3509 003 008 1	9
4111516522	3509 056 002 9	3509 056 002 9	9
4120000367	RLD5-R100	3754 047 008 0	240
Similar with 4111530002	RL3509BX-9	3509 056 001 9	9
Similar with 4111530022	3509 056 001 9	3509 056 001 9	9
4123520260	RL3509DH-C	3509 033 001 0	3

INDEX BY PART MANUFACTURERS

WABCO

Cross Ref.	SORL No.	SORL EU No	Page	Cross Ref.	SORL No.	SORL EU No	Page
4123529222	3509 033 002 9	3509 033 002 9	11	4324310022	RL3511FA-9	3511 009 101 9	45
4214110200	RL2135CA	2135 003 001 0	219	4324311910	RL3511FA	3511 009 001 0	27
4214120000	RL2135FC	2135 006 003 0	220	4325000200	RL3515ZA	3511 013 001 0	208
4220100100	RL3535FA	3535 001 001 0	220	4325000210	RL3515ZB	3511 013 002 0	208
4220100120	RL3535FA02	3535 002 002 0	220	4335010290	6060011047	6060011047	332
4220100140	RL3535GA	3535 002 001 0	221	4340140010	RL3525HA01	3525 008 001 0	212
4230005342	L-5	3530 888 026 9	242	4340140092	RL3525HA01-9	3525 008 001-9	214
4230005352	L-6	3530 888 027 9	242	4340141000	RL3525HA02	3525 008 002 0	212
4230570080	RL3519DA35	3519 090 104 0	246	4341000022	RL3531WA02-9	3531 013 002 0-9	71
4231030090	RL3519NA11	3519 360 019 0	247	4341000022	RL3531WA04-9	3531 013 003 0-9	71
4231039000	RL3519NA	3519 360 001 0	246	4341000240	RL3531WA02	3531 013 002 0	62
4231047100	RL3519HA11	3519 210 107 0	243	4341000470	RL3531WA11	3531 013 036 0	62
4231049000	RL3519YA1	3519 810 001 0	248	4341001220	RL3531WA08	3531 013 012 0	62
4231051110	RL3519JA19	3519 030 143 0	249	4341001230	RL3531WA06	3531 013 004 0	62
4231054060	RL3519JA37	3519 030 436 0	249	4341001240	RL3531WA07	3531 013 005 0	62
4231059000	RL3519JA18	3519 030 142 0	249	4341001250	RL3531WA01	3531 013 001 0	61
4231061060	RL3519AM09	3519 010 192 0	253	4341002200	RL3531WA09	3531 013 020 0	62
4231069000	RL3519ZA1	3519 820 001 0	253	4341002210	RL3531WA04	3531 013 003 0	62
4231079000	RL3519DA51	3519 090 100 0	258	4342050320	RL3548UB01	3548 038 001 0	222
4235050000	RL3519JA22	3519 030 267 0	244	4342080000	RL3533AE	3533 001 005 0	215
4235060020	RL3519AM37	3519 010 290 0	245	4342080090	RL3533AC	3533 001 003 0	215
4324070120	RL3511EG23	3511 007 023 8	41	4342080290	RL3533LA	3533 009 001 0	217
4324070150	RL3511EF02	3511 007 007 8	41	4342080300	RL3533LB22	3533 009 022 0	218
4324070600	RL3754AA01	3754 042 005 0	41	4410328080	3550 301 808 0	3550 301 808 0	158
4324070700	RL3511AD020	3511 003 005 8	41	4410328090	3550 301 809 0	3550 301 809 0	158
4324100002	RL3511AM-9	3511 003 025 9	44	4410328610	3550 301 861 0	3550 301 861 0	158
4324100070	RL3511AM18	3511 003 148 0	30	4410328750	3550 301 875 0	3550 301 875 0	158
4324100200	RL3511AM25	3511 003 155 0	30	4410329212	3550 305 808 0	3550 305 808 0	159
4324100202	RL3511KA	3513 001 001 0	40	4410329222	3550 305 809 0	3550 305 809 0	159
4324100210	RL3511AM-G	3511 003 051 0	28	4410329050	3550 332 003 0	3550 332 003 0	159
4324100330	RL3511AM24	3511 003 154 0	30	4410329632	3550 307 003 0	3550 307 003 0	159
4324100340	RL3511AM26	3511 003 156 0	31	4410400150	RLD5-M046	3802 121 001 0	179
4324100350	RL3511AM35	3511 003 198 0	31	4410435011	RL3511ZB01	3511 017 001 0	27
4324100410	RL3511AM-E	3511 003 049 0	28	4410441080	RLD5-M047	3802 122 001 0	179
4324100750	RL3511AM37	3511 003 200 0	31	4410500080	RL2908NA03	2908 013 003 0	178
4324100760	RL3511AM36	3511 003 199 0	31	4410500110	RL2908NA01	2908 013 001 0	178
4324100810	RL3511AM33	3511 003 184 0	31	4410500120	RL2908NA02	2908 013 002 0	178
4324100830	RL3511AM01-A	3511 003 143 0	30	4410501000	RLD5-M042	4101 099 002 0	179
4324100880	RL3511AM-F	3511 003 050 0	28	4410501230	RLD5-M041	4101 099 001 0	179
4324101020	RL3511AM	3511 003 025 0	28	4410507182	RL2908NA01-8	2908 013 001 8	170
4324101040	RL3511AM-A	3511 003 026 0	28	4411005312	RL1608EC04-8	1608 043 004 8	187
4324101110	RL3511AM-B	3511 003 027 0	28	4460043070	3550 101 441 0	3550 101 441 0	156
4324101130	RL3511AM02	3511 003 097 0	28	4460082340	3550 625 045 0	3550 625 045 0	209
4324101140	RL3511AM28	3511 003 158 0	31	4460082300	3550 625 045 0	3550 625 045 0	209
4324101150	RL3511AM04	3511 003 099 0	29	4460083802	3550 620 120 8	3550 620 120 8	211
4324101160	RL3511AM10	3511 003 130 0	29	4460083902	3550 625 045 8	3550 625 045 8	209
4324101170	RL3511AM03	3511 003 098 0	29	4460086002	3550 910 600 2	3550 910 600 2	211
4324101400	RL3511AM11	3511 003 137 0	30	449112xxx0	3550 620 060 0	3550 620 060 0	209
4324101520	RL3511AM12	3511 003 147 0	30	449112xxx0	3550 620 080 0	3550 620 080 0	209
4324101920	RL3511AM39	3511 003 192 0	30	449112xxx0	3550 620 120 0	3550 620 120 0	209
4324102202	RL3511KC	3513 001 003 0	40	4491120600	3550 623 060 0	3550 623 060 0	210
4324102262	RL3511HA	3513 001 004 0	40	4491120800	3550 623 080 0	3550 623 080 0	210
4324102500	RL3511AM30	3511 003 136 0	31	4491121200	3550 623 120 0	3550 623 120 0	210
4324109262	RL3511HA	3513 001 004 0	40	4491420500	3550 620 055 0	3550 620 055 0	209
4324109272	RL3511HA	3513 001 004 0	40	4491520600	3550 621 056 0	3550 621 056 0	209
4324130010	RL3511ES	3511 008 003 0	36	4494110050	3550 451 005 0	3550 451 005 0	160
4324130020	RL3511ES-A	3511 008 004 0	36	449413xxx0	3550 411 xxx 0	3550 411 xxx 0	160
4324150290	RL3511ER-B	3511 008 082 0	36	4494440220	3550 450 022 0	3550 450 022 0	161
4324200000	RL3511AZ	3511 003 036 0	29	449513xxx0	3550 410 xxx 0	3550 410 xxx 0	160
4324200020	RL3511AZ-A	3511 003 037 0	29	449711xxx0	3550 401 xxx 0	3550 401 xxx 0	160
4324200030	RL3511AZ-B	3511 003 038 0	29	449712xxx0	3550 420 xxx 0	3550 420 xxx 0	160
4324210020	RL3511AM05	3511 003 100 0	29	4520021070	RL3520AA	3520 001 001 0	203
4324251010	RL3511ED01	3511 021 001 0	37	4520021310	RL3520AA07	3520 001 007 0	203
4324251050	RL3511ED02	3511 021 002 0	37	4520021330	RL3520AA05	3520 001 005 0	203

INDEX BY PART MANUFACTURERS

WABCO

Cross Ref.	SORL No.	SORL EU No	Page	Cross Ref.	SORL No.	SORL EU No	Page
4522000000	RL3521BB01	3521 005 021 0	205	4613245200	RL3514DA-R	3514 012 002 0	77
4522000110	RL3521BB	3521 005 001 0	205	4614911020	RL3514ME11	3514 009 011 0	82
4522002210	RL3521BA-A	3521 004 002 0	205	4614945020	RL3514XD01	3514 022 001 0	87
4522002220	RL3521BC	3521 004 005 0	205	4630130042	RL3548AF-9	3548 001 004 0-9	229
4528020000	RL3521CC	3521 006 002 0	207	4630130042	RL3548AG-9	3548 001 003 0-9	229
4528020032	RL3521CA-9	3521 006 001 9	207	4630130052	RL3548MA-9	3548 015 001 0-9	229
4528020090	RL3521CA	3521 006 001 0	207	4630131120	RL3548AG02	3548 001 005 0	223
4528030050	RL3521CA03	3521 006 003 0	207	4630131140	RL3548AG	3548 001 003 0	223
4528040120	RL3521CB	3521 007 001 0	207	4630131160	RL3548AG22	3548 001 022 0	223
4528050040	RL3521CD04	3521 007 004 0	207	4630132000	RL3548NA	3548 014 001 0	223
4528060000	RL3521CE	3521 008 001 0	207	4630132100	RL3548PA	3548 013 001 0	224
4528080020	RL3521CF	3521 009 001 0	207	4630220200	RL3548MA	3548 015 001 0	223
4612951000	RL3514MH	3514 009 007 0	82	4630320012	RL8606BA-9	8606 002 001 0-9	172
4613070022	RL3514MA-9	3514 009 000 9	92	4630320200	RL8606BA	8606 002 001 0	171
4613070022	RL3514MB-9	3514 009 001 9	92	4630360000	RL1705CA	1705 003 001 0	224
4613070022	RL3514MC-9	3514 009 004 9	92	4630360050	RL1705CB	1705 003 002 0	224
4613070022	RL3514MD-9	3514 009 005 9	92	4630360160	RL1705CA08	1705 003 008 0	224
4613070022	RL3514ME-9	3514 009 002 9	92	4630360240	RL1705CA07	1705 003 007 0	224
4613070022	RL3514MF-9	3514 009 003 9	92	4630370010	RL1705UA	1705 009 001 0	224
4613072000	RL3514MA	3514 009 000 0	82	4630490500	RLD5-Z113	1705 509 001 0	199
4613074390	RL3514MD	3514 009 005 0	82	4630550500	RLD5-Z118	1705 510 001 0	199
4613074790	RL3514MB	3514 009 001 0	82	4630550520	RLD5-Z120	1705 512 001 0	200
4613150040	RL3514DS-D	3514 004 047 0	78	4630630002	RL1705RA-9	1705 007 001 0-9	229
4613150052	RL3514DA-F-9	3514 012 000 0-9	91	4630630002	RL1705RB-9	1705 007 002 0-9	229
4613150052	RL3514DA-G-9	3514 012 001 0-9	91	4630630020	RL1705RB	1705 007 002 0	226
4613150080	RL3514DS	3514 004 025 0	78	4630630030	RL1705RA	1705 007 001 0	226
4613150400	RL3514DX-D22	3514 004 222 0	80	4630690030	RL1705GA	1705 016 001 0	228
4613150420	RL3514DS-E	3514 004 052 0	78	4630840000	RL3548KA	3548 018 001 0	171
4613150530	RL3514DS-F	3514 004 048 0	78	4630840117	RL3548KB	3548 018 002 0	172
4613150570	RL3514DX-D35	3514 004 452 0	80	4630840300	RL8606HA	8606 009 001 0	172
4613150890	RL3514XD05	3514 024 005 0	87	4630840310	RL8606HB	8606 012 001 0	172
4613151560	RL3514DX-D03	3514 004 200 0	79	4630850000	RL1705AA01	1705 015 001 0	198
4613151570	RL3514DX-D41	3514 004 603 0	79	4637031000	RL3506AD	3506 001 003 0	74
4613152480	RL3514EA04	3514 013 024 0	81	4637031050	RL3506AB	3506 001 002 0	73
4613152610	RL3514EA-A	3514 013 001 0	80	4637031070	RL3506FA	3506 004 001 0	73
4613152580	RL3514EA	3514 013 000 0	80	4637031080	RL3506FC	3506 004 003 0	74
4613152640	RL3514EC	3514 013 004 0	81	4637031120	RL3506FB	3506 004 002 0	73
4613152670	RL3514EA01	3514 013 008 0	80	4640023300	RL2908FA	2908 006 001 0	165
4613159002	RL3514DS-9	3514 004 0259-1	91	4640060000	RL2908AB	2908 001 002 0	163
4613159002	RL3514DS-D-9	3514 004 047 9	91	4640060002	RL2908AA-9	2908 001 001 0-9	169
4613159002	RL3514DS-F-9	3514 004 052 9	91	4640060002	RL2908AB-9	2908 001 002 0-9	169
4613159142	RL3514EC-9	3514 013 004 0-9	91	4640060002	RL2908AD-9	2908 001 004 0-9	169
4613159202	RL3514EA-9	3514 013 000 9	91	4640060002	RL2908FA-9	2908 006 001 0-9	169
4613159282	RL3514DX-D09	3514 004 200 9	91	4640060010	RL2908AD	2908 001 004 0	163
4613170000	RL3514DX-D	3514 004 078 0	78	4640060020	RL2908AA	2908 001 001 0	163
4613170020	RL3514DX	3514 004 033 0	78	4640060030	RL2908AE	2908 001 005 0	164
4613170080	RL3514DV	3514 004 031 0	78	4640060050	RL2908AF	2908 001 006 0	164
4613170240	RL3514DG-A	3514 004 008 0	78	4640060110	RL2908AA13	2908 001 013 0	163
4613170510	RL3514DY	3514 004 036 0	80	4640060120	RL2908AA14	2908 001 014 0	163
4613180470	RL3514DX-D39	3514 004 539 0	79	4640061000	RL2908AA07	2908 001 007 0	163
4613180490	RL3514DX-D05	3514 004 300 0	79	4640061010	RL2908AA10	2908 001 010 0	163
4613186040	RL3514DX-D06	3514 004 400 0	79	4640070020	RL2908GB	2908 007 002 0	165
4613190022	RL3514EB-9	3514 013 002 9	91	4640070100	RL2908GA	2908 007 001 0	165
4613190022	RL3514EB-A-9	3514 013 003 9	91	4640070110	RL2908GC	2908 007 003 0	166
4613190022	RL3514EB-B-9	3514 013 006 9	91	4640070190	RL2908GA07	2908 007 007 0	165
4613190072	RL3514DD-9	3514 004 003 0-9	91	4640070300	RL2908GA19	2908 007 019 0	165
4613190080	RL3514DD	3514 004 003 0	77	4700120000	RL3514MF	3514 009 003 0	83
4613192500	RL3514EB-A	3514 013 003 0	81	4712000080	RL3522YB03	3522 009 003 0	123
4613192600	RL3514EB-B	3514 013 006 0	81	4720174800	RL8606JA	8606 011 001 0	211
4613192620	RL3514EB01	3514 013 023 0	81	4720174810	RL8606JB	8606 011 002 0	211
4613192710	RL3514EB	3514 013 002 0	81	4720706390	RLD5-R048	3754 012 049 0	238
4613192740	RL3514EA03	3514 013 017 0	81	4720706390	RLD5-R048	3754 012 049 0	238
4613240100	RL3514DA-F	3514 012 000 0	77	4721271400	RLD5-R061	3754 055 001 0	240
4613240160	RL3514DA-G	3514 012 001 0	77				

INDEX BY PART MANUFACTURERS

WABCO

Cross Ref.	SORL No.	SORL EU No	Page	Cross Ref.	SORL No.	SORL EU No	Page
4721706060	RLD5-R050	3754 012 052 0	238	4750100090	RL3531NB	3531 008 002 0	63
4721706160	RLD5-R051	3754 012 045 0	239	4750100130	RL3531NA04	3531 008 004 0	63
4721707960	RLD5-R052	3754 012 054 0	239	4750100250	RL3531NA	3531 008 001 0	62
4721710000	RLD5-R053	3754 012 037 0	239	4750103000	RL3512MA17	3512 010 017 0	65
4721717000	RLD5-R054	3754 012 051 0	239	4750103010	RL3512MA03	3512 010 003 0	64
4721717060	RLD5-R055	3754 012 048 0	239	4750103020	RL3512MA04	3512 010 004 0	64
4721726060	RLD5-R056	3754 012 044 0	239	4750103030	RL3512MA05	3512 010 005 0	64
4721726860	RLD5-R057	3754 012 046 0	239	4750103040	RL3512MA06	3512 010 006 0	64
4721727860	RLD5-R059	3754 012 047 0	240	4750103050	RL3512MA07	3512 010 007 0	64
4721732260	RLD5-R058	3754 012 038 0	239	4750103060	RL3512MA08	3512 010 008 0	64
4721950160	RL3550SM24	3550 210 024 0	157	4750103070	RL3512MA09	3512 010 009 0	64
4721950180	RL3550FA	3550 210 018 0	157	4750103080	RL3512MA10	3512 010 010 0	65
4721950200	RL3518ZC-C	3518 020 006 0	157	4750103090	RL3512MA11	3512 010 011 0	65
4721950270	RL3518ZC25	3518 020 025 0	157	4750103100	RL3512MA12	3512 010 012 0	65
4721950310	RL3518ZC	3518 020 001 0	157	4750103110	RL3512MA13	3512 010 013 0	65
4721950410	RL3518ZZ	3518 020 003 0	156	4750103120	RL3512MA14	3512 010 014 0	65
4721950440	RL3518ZZ-A	3518 020 008 0	157	4750103130	RL3512MA15	3512 010 015 0	65
4722500000	RL3754PT02	3754 100 002 0	240	4750103150	RL3512MA20	3512 010 020 0	66
4722500030	RL3754PT01	3754 100 001 0	240	4750103160	RL3512MA21	3512 010 021 0	66
4728800640	RL3754EC301	3754 046 001 0	177	4750103170	RL3512MA22	3512 010 022 0	66
4729000010	RL3754EC100	3754 042 100 0	175	4750103180	RL3512MA23	3512 010 023 0	66
4729000020	RL3754EC101	3754 042 101 0	175	4750103190	RL3512MA24	3512 010 024 0	66
4729000060	RL3754EC103	3754 042 103 0	175	4750103200	RL3512MA25	3512 010 025 0	66
4729000090	RL3754EC106	3754 042 106 0	175	4750103210	RL3512MA26	3512 010 026 0	66
4729000120	RL3754EC107	3754 042 107 0	175	4750103220	RL3512MA27	3512 010 027 0	67
4729000210	RL3754EC110	3754 042 110 0	176	4750103230	RL3512MA28	3512 010 028 0	67
4729000220	RL3754EC111	3754 042 111 0	176	4750103240	RL3512MA16	3512 010 016 0	65
4729000300	RL3754EC112	3754 042 112 0	176	4750103250	RL3512MA29	3512 010 029 0	67
4729000320	RL3754EC113	3754 042 113 0	176	4750103260	RL3512MA30	3512 010 030 0	67
4729000500	RL3754EC120	3754 042 120 0	176	4750103280	RL3512MA31	3512 010 031 0	67
4729000510	RL3754EC119	3754 042 119 0	176	4750103290	RL3512MA32	3512 010 032 0	67
4729000520	RL3754EC118	3754 042 118 0	176	4750103300	RL3512MA34	3512 010 034 0	67
4729000530	RL3754EC02	3754 042 002 0	173	4750103310	RL3512MA35	3512 010 035 0	68
4729000540	RL3754EC10	3754 042 010 0	174	4750103320	RL3512MA36	3512 010 036 0	68
4729000550	RL3754EC07	3754 042 007 0	173	4750103330	RL3512MA33	3512 010 033 0	67
4729000560	RL3754EC01	3754 042 001 0	173	4750103340	RL3512MA37	3512 010 037 0	68
4729000570	RL3754EC20	3754 042 020 0	174	4750103350	RL3512MA38	3512 010 038 0	68
4729000580	RL3754EC11	3754 042 011 0	174	4750103380	RL3512MA39	3512 010 039 0	68
4729000590	RL3754EC117	3754 042 117 0	176	4750103390	RL3512MA40	3512 010 040 0	68
4729000600	RL3754EC03	3754 042 003 0	173	4750104000	RL3512MA	3512 010 001 0	68
4729000610	RL3754EC09	3754 042 009 0	173	4750150010	RL3531MA24	3531 007 024 0	63
4729000620	RL3754EC04	3754 042 004 0	173	4750150040	RL3531MA06	3531 007 006 0	63
4729000630	RL3754EC12	3754 042 012 0	174	4750150310	RL3531MA	3531 007 001 0	63
4729000660	RL3754EC14	3754 042 014 0	174	4750150630	RL3531MA08	3531 007 008 0	63
4729000670	RL3754EC21	3754 042 021 0	174	4756040100	RL3520AB-A	3520 002 002 0	203
4729000730	RL3754EC06	3754 042 006 0	173	4756040110	RL3520AB	3520 002 001 0	203
4729000740	RL3754EC13	3754 042 013 0	174	4756040130	RL3520DA	3520 003 001 0	203
4729000760	RL3754EC15	3754 042 015 0	174	4757000042	RL3523DA-9	3523 002 009 9	111
4729001010	RL3754EC115	3754 042 115 0	177	4757004030	RL3523DA	3523 002 009 0	110
4729001020	RL3754EC116	3754 042 116 0	177	4757100000	RL3523AB-B	3523 001 022 0	107
4729001100	RL3754EC16	3754 042 016 0	174	4757100012	RL3523AA-A-9	3523 001 019 0-9	111
4729001120	RL3754EC17	3754 042 017 0	175	4757100012	RL3523AB-A-9	3523 001 021 0-9	111
4729001130	RL3754EC18	3754 042 018 0	175	4757100012	RL3523AB-B-9	3523 001 022 0-9	111
4729001140	RL3754EC19	3754 042 019 0	175	4757100012	RL3523AB-C-9	3523 001 023 0-9	111
4729051110	RL3754EC-B	3754 044 003 0	177	4757100012	RL3523AB-D-9	3523 001 024 0-9	111
4729051140	RL3754EB-B	3754 044 002 0	177	4757100012	RL3523AB-E-9	3523 001 025 0-9	111
4729051160	RL3754EC-C	3754 044 005 0	177	4757100060	RL3523AB10	3523 001 110 0	107
4729051180	RL3754EC-A	3754 044 001 0	177	4757100080	RL3523AB-A	3523 001 021 0	107
4730170002	RL3518KM-9	3518 009 025 0-9	154	4757100200	RL3523AB-D	3523 001 024 0	108
4730170010	RL3518KA01	3518 009 033 0	139	4757100220	RL3523AA09	3523 001 084 0	106
4730170050	RL3518KM	3518 009 025 0	139	4757101210	RL3523AB02	3523 001 102 0	107
4730170070	RL3518KH	3518 009 024 0	139	4757101360	RL3523AB-L	3523 001 157 0	108
4730170080	RL3518KA-A	3518 009 032 0	139	4757110002	RL3523AK-9	3523 002 0019-1	111
4735010040	RL3516BD34	3516 002 034 0	116	4757110002	RL3523AK-A-9	3523 002 006 0-9	111

INDEX BY PART MANUFACTURERS

WABCO

Cross Ref.	SORL No.	SORL EU No	Page	Cross Ref.	SORL No.	SORL EU No	Page
4757110120	RL3523AK-A	3523 002 006 0	109	9254310957	RL3530CA80	3530 060 179 0	271
4757110240	RL3523AK-B	3523 002 007 0	109	9254321050	RL3530SA1	3530 480 025 0	275
4757110290	RL3523AK06	3523 002 028 0	109	9254500047	RL3530PF01	3530 301 001 0	270
4757110750	RL3523AK01	3523 002 019 0	109	Alternative 9254601000	RL3530PF22	3530 390 022 0	265
4757111010	RL3523AK-E	3523 002 011 0	110	Alternative 9254601010	RL3530PE02	3530 390 023 0	265
4757111080	RL3523AK	3523 002 001 0	109	Alternative 9254601020	RL3530PE04	3530 390 024 0	265
4757111260	RL3523AK-D	3523 002 010 0	109	Alternative 9254601030	RL3530PE05	3530 390 025 0	265
4757111550	RL3523AK04	3523 002 026 0	109	Alternative 9254601040	RL3530PE06	3530 390 026 0	265
4757120000	RL3523CB	3523 005 002 0	108	Alternative 9254601050	RL3530PE07	3530 390 027 0	265
4757120002	RL3523CA-9	3523 005 0019-1	111	Alternative 9254601070	RL3530PE08	3530 390 028 0	265
4757120002	RL3523CB-9	3523 005 002 9	111	Alternative 9254601080	RL3530PE03	3530 390 029 0	265
4757120002	RL3523CC-9	3523 005 003 9	111	Alternative 9254601090	RL3530PE09	3530 390 030 0	265
4757120040	RL3523CA	3523 005 001 0	108	9254610000	RL3530CA35	3530 060 162 0	267
4757120050	RL3523CC	3523 005 003 0	108	9254610010	RL3530CA36	3530 060 172 0	267
4757140002	RL3523AK-C-9	3523 002 008 9	111	Alternative 9254610100	RL3530CA92	3530 060 178 0	266
4757145000	RL3523AK-C	3523 002 008 0	110	9254612900	RL3530YX11	3530 850 001 0	266
4757150000	RL3523BB-A	3523 005 005 0	110	9254644520	RL3530YZ9	3530 241 009 0	264
4757150002	RL3523BB-9	3523 005 004 0-9	111	9254645000	RL3530RY7	3530 452 007 0	265
4757155000	RL3523BB	3523 005 004 0	110	9254645010	RL3530RY8	3530 452 008 0	265
4757210010	RL3523GC	3523 013 001 0	110	9254680100	RL3530YX1	3530 690 001 0	264
4758003010	RL3523GB	3523 012 001 0	108	9254680120	RL3530YX2	3530 690 002 0	264
4757100360	RL3523AB-C	3523 001 023 0	107	9254680130	RL3530YX3	3530 690 003 0	264
5340170090	RL3533NA01	3533 012 001 0	218	9254880150	RL3530YX9	3530 690 013 0	264
5710031040	RL1705BA	1705 012 001 0	225	9254680200	RL3530YX4	3530 690 004 0	264
5710400000	RL1705PA01	1705 056 001 0	225	9254680210	RL3530YX5	3530 690 005 0	264
8305020684	3550 990 200 0	3550 990 200 0	160	9254680220	RL3530YX6	3530 690 006 0	264
8845019220	RL3526XA02	3526 040 002 0	100	9254680230	RL3530YX7	3530 690 007 0	264
8845021050	RL3526BK01	3526 002 123 0	94	Alternative 9254800100	RL3530PE73	3530 390 177 0	266
8845022560	RL3518ZA04	3518 019 039 0	141	9254810120	RL3530CA53	3530 060 427 0	267
8845027500	RL3530CA1	3530 060 077 0	271	9254810130	RL3530CA54	3530 060 428 0	267
8845027550	RL3530AA1	3530 010 140 0	274	9254812000	RL3530CA56	3530 060 434 0	267
8845034370	RL3509BX	3509 056 001 0	2	9254812010	RL3530CA57	3530 060 435 0	267
8845035860	RL3509CH	3509 029 001 0	3	9254840100	RL3530RY10	3530 452 011 0	265
8847978114	3550 702 166 1	3550 702 166 1	162	9254840110	RL3530RY11	3530 452 012 0	265
8942600402	K2422	3511 012 003 0	42	9254840200	RL3530RY2	3530 452 002 0	265
8942600432	K2442	3511 012 007 0	42	9254840210	RL3530RY1	3530 452 001 0	265
8942600442	K1221	3511 012 002 0	42	9254840220	RL3530RY3	3530 452 003 0	265
8942600462	K1251	3511 012 008 0	42	9254840230	RL3530RY4	3530 452 004 0	265
8942600472	K2452	3511 012 009 0	42	9254840260	RL3530RY5	3530 452 005 0	265
8942600492	K2432	3511 012 005 0	42	9254840270	RL3530RY6	3530 452 006 0	265
8946011322	3550 430 002 0	3550 430 002 0	160	9254860100	RL3530SY1	3530 240 001 0	263
8997598154	3550 301 510 4	3550 301 510 4	159	9254860110	RL3530SY2	3530 240 002 0	263
8997605104	3550 301 815 4	3550 301 815 4	160	9254880100	RL3530YX10	3530 690 015 0	264
9111457372	3509 003 005 8	3509 003 005 8	9	9254880140	RL3530YX8	3530 690 012 0	264
9111457382	3509 033 001 8	3509 033 001 8	11	9254911420	RL3530CA55	3530 060 429 0	270
9111530010	RL3509DH-B	3509 032 001 0	3	Alternative 9254921020	RL3530SB19	3530 480 098 0	275
9115016242	3509 003 004 9	3509 003 004 9	10	9254941080	RL3530RY9	3530 452 009 0	269
9115040520	RL3509BJ	3509 010 001 0	4	9324000002	RL3511DH-9	3511 006 009 0-9	44
9115530020	RL3509BC	3509 003 001 0	3	9324000020	RL3511DG42	3511 006 042 0	36
9125101040	RL3509DH-E	3509 035 001 0	4	9324000030	RL3511DH-A	3511 006 010 0	36
ALTERNATIVE 9253211600	RL3530CA-A58	3530 060 458 0	272	9324000240	RL3511DG02	3511 006 030 0	36
9253212020	RL3530CA93	3530 060 907 0	273	9325000030	RL3511DG	3511 006 007 0	26
9253221550	RL3530SB11	3530 480 221 0	275	9325000040	RL3511DG-A	3511 006 008 0	26
9253224230	RL3530SB12	3530 480 222 0	276	9325000060	RL3511DG34	3511 006 034 0	27
9253224240	RL3530SB1	3530 480 031 0	275	9325000070	RL3511DG32	3511 006 032 0	27
9253713000	RL3530EY15	3530 120 089 0	282	9325000130	RL3511DG33	3511 006 033 0	27
9254220700	RL3530SA5	3530 480 029 0	275	9325000140	RL3511DG31	3511 006 031 0	27
9254241000	RL3530RA16	3530 450 040 0	268	9325000350	RL3511EQ78	3511 007 078 0	26
9254248000	RL3530YZ4	3530 241 004 0	263	9343000010	RL3513BB02	3536 001 008 0	74
9254248010	RL3530YZ5	3530 241 005 0	263	9343000030	RL3513BB	3536 001 001 0	74
9254261000	RL3530YY1	3530 630 005 0	263	9347000002	RL3515HB-9	3515 005 002 0-9	58
9254261010	RL3530YY2	3530 630 011 0	263	9347000400	RL3515HB	3515 005 002 0	57
9254262000	RL3530YZ1	3530 241 001 0	263	9347020000	RL3515EA06	3515 003 020 0	50
9254262010	RL3530YZ2	3530 241 002 0	263	9347020012	RL3515EA-B-9	3515 003 003 0-9	58

INDEX BY PART MANUFACTURERS

WABCO

Cross Ref.	SORL No.	SORL EU No	Page	Cross Ref.	SORL No.	SORL EU No	Page
9347020042	RL3515EA-A-9	3515 003 002 0-9	58	9617221820	RL3526AK01	3526 002 150 0	93
9347020062	RL3515EA-D-9	3515 003 005 0-9	58	9617222120	RL3526RA	3526 010 001 0	96
9347020400	RL3515EA10	3515 003 024 0	51	9617222320	RL3526RB	3526 010 002 0	96
9347020410	RL3515EA09	3515 003 012 0	50	9617222520	RL3526CK	3526 001 011 0	95
9347020820	RL3515EA03	3515 003 017 0	50	9617222580	RL3526EK	3526 001 016 0	96
9347022100	RL3515DA	3515 002 001 0	49	9617222640	RL3526CK116	3526 001 116 0	96
9347022210	RL3515DA05	3515 002 005 0	49	9617222750	RL3526CK04	3526 001 110 0	95
9347022400	RL3515DA06	3515 002 006 0	49	9617222840	RL3526CK03	3526 001 104 0	95
9347022500	RL3515KE	3515 006 005 0	49	9617223050	RL3526CK37	3526 001 037 0	95
9347022600	RL3515WA01	3515 017 001 0	49	9617223140	RL3526CK05	3526 001 113 0	95
9347023000	RL3515EA-A	3515 003 002 0	51	9617223150	RL3526CK06	3526 001 114 0	95
9347023020	RL3515EA05	3515 003 019 0	50	9617230002	RL3526DX-9	3526 005 001 9	104
9347023200	RL3515EA-B	3515 003 003 0	51	9617230002	RL3526DY-9	3526 005 002 9	104
9347023220	RL3515EA01	3515 003 010 0	50	9617230010	RL3526BB	3526 004 002 0	94
9347023400	RL3515EA-C	3515 003 004 0	51	9617230012	RL3526BA-9	3526 004 0019-1	104
9347023800	RL3515EA-D	3515 003 005 0	51	9617230012	RL3526BB-9	3526 004 0029-1	104
9347023810	RL3515EA-H	3515 003 008 0	51	9617230040	RL3526BA07	3526 004 155 0	93
9347023870	RL3515EA04	3515 003 018 0	50	9617230042	RL3526NA-9	3526 006 001 0-9	104
9347023900	RL3515EA07	3515 003 021 0	50	9617230042	RL3526NB-9	3526 006 002 0-9	104
9347050010	RL3515SA06	3515 011 021 0	56	9617230050	RL3526NA-B	3526 006 009 0	98
9347050020	RL3515SA	3515 011 001 0	55	9617230190	RL3526NA	3526 006 001 0	98
9347050050	RL3515SA01	3515 011 013 0	56	9617230210	RL3526BA01	3526 004 017 0	93
9347140080	RL3515MB06	3515 008 067 0	53	9617230380	RL3526BA03	3526 004 100 0	94
9347140090	RL3515MB07	3515 008 086 0	53	9617230640	RL3526BA14	3526 004 245 0	94
9347140100	RL3515MA	3515 008 001 0	52	9617231000	RL3526DX07	3526 005 051 0	97
9347140130	RL3515MB	3515 008 002 0	52	9617231020	RL3526DC	3526 005 003 0	96
9347141190	RL3515MB01	3515 008 017 0	52	9617231040	RL3526NB	3526 006 002 0	98
9347141230	RL3515MB04	3515 008 045 0	53	9617231080	RL3526DY	3526 005 002 0	97
9347141250	RL3515MA35	3515 008 035 0	52	9617231110	RL3526DX03	3526 005 018 0	97
9347141520	RL3515MB03	3515 008 044 0	53	9617231220	RL3526XB01	3526 041 001 0	100
9347142110	RL3515MB02	3515 008 041 0	52	9617231250	RL3526XC01	3526 042 001 0	100
9347144030	RL3515MB05	3515 008 046 0	53	9617231570	RL3526DC06	3526 005 114 0	96
9347147400	RL3515XC01	3515 025 001 0	55	9617232080	RL3526DX06	3526 005 100 0	97
9349010022	RL3515EA-C-9	3515 003 004 0-9	58	9617232130	RL3526DC05	3526 005 105 0	96
9349010052	RL3515DA-9	3515 002 001 0-9	58	9617232170	RL3526XB03	3526 041 003 0	100
9349010052	RL3515KB-9	3515 006 002 0-9	58	9617234210	RL3526NA38	3526 006 038 0	98
9500600030	RL3513FC	3513 006 004 0	73	9630010010	RL3520AC	3520 502 001 0	135
9500800020	RL3513WA01	3513 009 001 0	73	9630010120	RL3520ZB	3520 501 002 0	135
95220000210	RL3521BB-A	3521 005 002 0	205	9630010130	RL3520ZA	3520 501 001 0	135
95220000220	RL3521BD-A	3521 005 005 0	206	9630010500	RL3520ZD03	3520 504 003 0	136
9522010010	RL3521EA02	3521 014 002 0	206	9630010510	RL3520ZD02	3520 504 002 0	136
9522010020	RL3521EA01	3521 014 001 0	206	9630010520	RL3520ZD01	3520 504 001 0	136
9617010002	RL3526PA-9	3526 008 003 9	105	9630060002	RL3520ZA-9	3520 501 001 0-9	138
9617010002	RL3526PD-9	3526 008 004 9	105	9630060002	RL3520ZB-9	3520 501 002 0-9	138
9617011000	RL3526PA	3526 008 001 0	99	9630060002	RL3520ZC-9	3520 501 003 0-9	138
9617011050	RL3526PD	3526 008 004 0	99	9630060002	RL3527DD-9	3527 004 004 9	137
9617020010	RL3526PB	3526 008 002 0	99	9630060002	RL3527DE-9	3527 004 005 0-9	137
9617020012	RL3526PB-9	3526 008 002 0-9	105	9630060010	RL3520ZC	3520 501 003 0	136
9617020012	RL3526PC-9	3526 008 003 0-9	105	9630060030	RL3520ZA05	3520 501 005 0	135
9617020080	RL3526PC	3526 008 003 0	99	9700511000	RL1608PC-A	1608 044 033 0	189
9617100540	RL3526WA02	3526 039 002 0	99	9700511020	RL1608PR	1608 045 004 0	189
9617100560	RL3526WA01	3526 039 001 0	99	9700511070	RL1608PL	1608 045 005 0	191
9617210000	RL3526VA	3526 020 001 0	99	9700511110	RL1608PA03	1608 044 012 0	189
9617210040	RL3526VB	3526 020 002 0	99	9700511140	RL1608PC	1608 045 001 0	189
9617210082	RL3526VA-9	3526 020 001 0-9	104	9700511240	RL1608PE	1608 053 001 0	191
9617220022	RL3526AK-9	3526 002 010 9	104	9700511250	RL1608PA08	1608 044 021 0	189
9617220022	RL3526BK-9	3526 004 010 9	104	9700511260	RL1608PQ	1608 045 003 0	189
9617220032	RL3526CK-9	3526 001 0119-1	104	9700511280	RL1608PE02	1608 053 003 0	191
9617220032	RL3526EK-9	3526 001 016 0-9	104	9700511310	RL1608KA	1608 039 001 0	185
9617220032	RL3526FK-9	3526 001 017 9	104	9700519032	RL1608KA-9	1608 039 001 0-9	194
9617220032	RL3526RA-9	3526 010 001 9	104	9700511370	RL1608PK	1608 044 006 0	190
9617220032	RL3526RB-9	3526 010 0029-1	104	9700511510	RL1608PS	1608 048 001 0	188
9617221510	RL3526AK	3526 002 010 0	93	9700511520	RL1608PH	1608 044 004 0	190
9617221600	RL3526BK-B	3526 002 125 0	93	9700511560	RL1608PB	1608 044 002 0	190

INDEX BY PART MANUFACTURERS

WABCO

Cross Ref.	SORL No.	SORL EU No	Page	Cross Ref.	SORL No.	SORL EU No	Page
9700511570	RL1608PA06	1608 044 016 0	188	9710025300	RL3518NA	3527 003 001 0	132
9700511580	RL1608LB	1608 041 001 0	185	9710025310	RL3518ND	3527 003 004 0	132
9700511590	RL1608LB-A	1608 041 002 0	185	9710025470	RL3518NE	3527 003 005 0	132
9700511640	RL1608PA01	1608 044 009 0	188	9710025700	RL3518NF	3527 003 006 0	133
9700511650	RL1608PJ	1608 044 005 0	190	9710027000	RL3527DD	3527 004 004 0	132
9700511700	RL1608PG	1608 044 003 0	190	9710027010	RL3527DE	3527 004 005 0	132
9700511720	RL1608PU	1608 044 008 0	188	9710028050	RL3527DE07	3527 004 007 0	132
9700511740	RL1608PA02	1608 044 010 0	190	9700511360	RL1608PA04	1608 044 013 0	189
9700511760	RL1608PA05	1608 044 014 0	190	9700514410	RL1608EC14	1608 043 014 0	187
9700511790	RL1608PE01	1608 053 002 0	191	9730010002	RL3518AH-9	3518 001 009 0-9	154
9700511830	RL1608PT	1608 047 001 0	190	9730010002	RL3518AK-9	3518 001 013 0-9	154
9700511840	RL1608PA07	1608 044 017 0	191	9730010062	RL3518AZ-9	3518 001 015 0-9	154
9700511900	RL1608PS01	1608 048 002 0	191	9730010100	RL3518AH	3518 001 009 0	140
9700512090	RL1608PF	1608 046 001 0	191	9730010130	RL3518AY	3518 001 014 0	140
9700512260	RL1608PF01	1608 046 003 0	191	9730010180	RL3518AF-A	3518 001 007 0	140
9700514070	RL1608EA	1608 042 001 0	186	9730010190	RL3518AH02	3518 001 057 0	140
9700514120	RL1608EA15	1608 042 052 0	186	9730010200	RL3518AK	3518 001 013 0	140
9700514130	RL1608EF	1608 042 003 0	187	9730012110	RL3518AZ	3518 001 015 0	140
9700514140	RL1608EH	1608 042 004 0	188	9730020000	RL3522AZ13	3522 001 013 0	121
9700514220	RL1608EA08	1608 042 023 0	186	9730020042	RL3522AH-9	3522 001 001 9	124
9700514230	RL1608EE	1608 042 002 0	187	9730020052	RL3522BJ-9	3522 002 010 0-9	124
9700514240	RL1608EA09	1608 042 021 0	186	9730020052	RL3522BJ-A-9	3522 002 011 0-9	124
9700514310	RL1608EC01	1608 043 003 0	187	9730020062	RL3522BH-9	3522 002 001 0-9	124
9700514330	RL1608EC09	1608 043 009 0	187	9730020070	RL3522AZ	3522 001 008 0	121
9700514350	RL1608EA02	1608 042 006 0	186	9730024000	RL3522AB01	3522 001 014 0	121
9700514380	RL1608HA10	1608 090 010 0	188	9730024020	RL3522AH	3522 001 001 0	121
9700514550	RL1608HA01	1608 090 001 0	188	9730024230	RL3522AZ-A	3522 001 011 0	121
9700514570	RL1608EH31	1608 042 031 0	188	9730025000	RL3522BB	3522 002 002 0	121
9700519042	RL1608PA-9	1608 044 001 0-9	196	9730025010	RL3522BJ	3522 002 010 0	121
9700519042	RL1608PC-9	1608 045 001 9	196	9730025060	RL3522BB	3522 002 002 0	121
9700519042	RL1608PQ-9	1608 045 0030-9	196	9730025200	RL3522BH	3522 002 001 0	121
9700519042	RL1608PR-9	1608 045 004 0-9	196	9730025210	RL3522BJ-A	3522 002 011 0	122
9700519062	RL1608PE-9	1608 053 010 9	196	9730025220	RL3522BH02	3522 002 021 0	122
9700519062	RL1608PL-9	1608 053 011 9	196	9730025390	RL3522BJ-B	3522 002 012 0	122
9700519102	RL1608PK-9	1608 044 006 0-9	196	9730060010	RL3518AE01	3518 042 001 0	142
9700519102	RL1608PT-9	1608 047 001 0-9	196	9730090002	RL3522FB-9	3522 004 002 0-9	124
9700519162	RL1608LB-9	1608 041 110 9	194	9730090002	RL3522FB-A-9	3522 004 003 9	124
9700519162	RL1608LB-A-9	1608 041 002 9	194	9730090002	RL3522FB-C-9	3522 004 004 9	124
9700519192	RL1608PG-9	1608 044 003 0-9	196	9730090010	RL3522FB-A	3522 004 003 0	123
9700519192	RL1608PH-9	1608 044 004 0-9	196	9730090012	RL3522FA-9	3522 004 001 0-9	124
9700519432	RL1608EA-9	1608 042 001 9	195	9730090020	RL3522FB-C	3522 004 004 0	123
9700519432	RL1608EE-9	1608 053 013 9	195	9730090060	RL3522FA01	3522 004 012 0	122
9700519432	RL1608EF-9	1608 053 014 9	195	9730090100	RL3522FB	3522 004 002 0	123
9700519442	RL1608PJ-9	1608 044 005 0-9	196	9730090110	RL3522FA02	3522 004 030 0	122
9700519452	RL1608EB09-9	1608 044 009 9	195	9730093000	RL3522FA	3522 004 001 0	122
9700519492	RL1608EC-9	1608 043 001 0-9	195	9730110000	RL3518ZA	3518 019 001 0	141
9700519502	RL1608EB14-9	1608 044 014 9	195	9730110010	RL3518ZB-A	3518 019 003 0	141
9710020000	RL3518NC	3527 003 003 0	133	9730110040	RL3518ZH	3518 019 010 0	141
9710020032	RL3518NA-9	3527 003 001 0-9	137	9730110050	RL3518ZF	3518 019 004 0	141
9710020032	RL3518NB-9	3527 003 002 0-9	137	9730110070	RL3518ZA05	3518 019 044 0	141
9710020042	RL3518MA-9	3527 002 001 9	137	9730110500	RL3518ZA77	3518 019 077 0	141
9710020042	RL3518MB-9	3527 002 002 9	137	9730112000	RL3518ZE-B	3518 019 009 0	142
9710020062	RL3518NC-9	3527 003 003 0-9	138	9730112010	RL3518ZA01	3518 019 020 0	142
9710020082	RL3527DA-9	3527 004 001 0-9	137	9730112030	RL3518ZE-A	3518 019 008 0	142
9710020082	RL3527DB-9	3527 004 002 0-9	137	9730112050	RL3518ZE	3518 019 006 0	142
9710020082	RL3527DD-9	3527 004 004 9	137	9730112060	RL3518ZA07	3518 019 060 0	141
9710020082	RL3527DE-9	3527 004 005 0-9	137	9735000000	RL3516ED	3516 005 002 0	112
9710020082	RL3527DF-9	3527 004 006 0-9	137	9735000030	RL3516EE	3516 005 003 0	112
9710021500	RL3518NB	3527 003 002 0	133	9735000060	RL3516EH	3516 005 006 0	113
9710021510	RL3518MB	3527 002 002 0	133	9735000110	RL3516EG	3516 005 005 0	113
9710021520	RL3518MA	3527 002 001 0	133	9735000130	RL3516EX	3516 005 013 0	113
9710023000	RL3527DF	3527 004 006 0	132	9735000140	RL3516BH01	3516 002 039 0	112
9710023040	RL3527DA	3527 004 001 0	131	9735000170	RL3516BC25	3516 002 025 0	114
9710023070	RL3527DB	3527 004 002 0	131	9735000180	RL3516ET	3516 005 015 0	113

INDEX BY PART MANUFACTURERS

WABCO

Cross Ref.	SORL No.	SORL EU No	Page
9735000380	RL3516UA01	3516 022 001 0	113
9735000470	RL3516BX	3516 002 018 0	115
9735000510	RL3516XA01	3516 020 001 0	113
9750010000	RL3516QA01	3516 070 001 0	112
9753000002	RL3512AB-9	3512 006 102 9	25
9753000140	RL3512AC	3512 006 003 0	17
9753001100	RL3512AB	3512 006 002 0	17
9753030012	RL3512BG-9	3512 007 007 0-9	25
9753030012	RL3512BJ-9	3512 007 014 0-9	25
9753030012	RL3512BK-9	3512 007 015 0-9	25
9753030600	RL3512BG03	3512 007 060 0	19
9753030710	RL3512BG01	3512 007 058 0	19
9753030800	RL3512BG02	3512 007 059 0	19
9753030850	RL3512BH	3512 007 013 0	20
9753031690	RL3512BG08	3512 007 065 0	20
9753034470	RL3512BG29	3512 007 089 0	20
9753034640	RL3512BG	3512 007 007 0	18
9753034720	RL3512BG05	3512 007 062 0	19
9753034730	RL3512BJ	3512 007 014 0	18
9753034740	RL3512BK	3512 007 015 0	18
9753034800	RL3512BG07	3512 007 064 0	19
9753035030	RL3512BG06	3512 007 063 0	19
9753035040	RL3512BG04	3512 007 061 0	19
APSA5890	RL3526FA	3526 003 001 0	101
OTHERS			
03342-14000	RL3548HA	3548 008 001 0	236
03342-56000	RL3516DA	3516 004 001 0	116
100304941	RL3511XA02	3511 018 002 0	26
10410108	RL3511XD02	3511 022 002 0	37
10410109	RL3511XD03	3511 022 003 0	37
11100	RL3518ST	3518 024 001 0	150
11441P	RL3521NA02	3521 015 002 0	206
11445P	RL3521NA01	3521 015 001 0	206
13635002	RLWM100-1605010	1604 192 015 0	198
14096353X0002	RL3526NA-C	3526 006 006 0	98
16743	RL3531YA01	3531 016 001 0	70
17600B	RL3548GB	3548 007 002 0	237
17482213	499011011207	499011011207	330
20.34541075	RL3519HA24	3519 210 124 0	243
20QE3126-P2	RL2908JA	2908 008 001 0	167
23500-1010	RL3529EA	3529 001 001 0	17
263243700109	RL3514DX-D30	3514 004 330 0	88
263243700163	RL3514XC01	3514 021 001 0	88
3100	RL3518QA	3518 012 001 0	135
350360011	RL3516YA01	3516 021 001 0	113
8847978114	3550 702 166 1	3550 702 166 1	162
4300810	RL3548DH02	3548 000 002 0	235
43-088	RL1705GA02	1705 016 002 0	228
43-108	RL3526HC13	3526 027 001 0	103
43-439	RL3519HA14	3519 210 333 0	248
5001909	RL3513XC01	3513 019 001 0	59
5004341	RL3511XD33-9	3511 022 003 9	45
5004342	RL3511XD44-9	3511 022 004 9	45
52341-Q135	RL2908HA	2908 009 001 0	167
585LL	RLD5-Z082	1705 501 001 0	198
5900	RL3526KA	3526 015 001 0	101
612600130307	RL3509DJ-D	3509 040 001 0	2
612600130496	RL3509DJ-E	3509 041 001 0	2
63.5713.00	RL1608DB	1608 006 002 0	185
670046	RL1704DA	1704 004 001 0	227
228600	RLD5-M022	4101 039 001 0	70
8300310	RL3514DX-D31	3514 004 331 0	88

Cross Ref.	SORL No.	SORL EU No	Page
920100	RL3526HB02	3526 016 007 0	102
950100	RL3527UA01	3527 010 001 0	133
951400	RL3527UA02	3527 010 002 0	133
A1000	RL3518QP01	3518 027 001 0	135
A1000	RL3518QP02	3518 027 002 0	135
A3546	RL3548LC01	3548 023 001 0	237
A3546	RL3548LC02	3548 023 002 0	237
A4041	RL3511MA01	3511 013 003 0	74
A4041	RL3511MA02	3511 013 005 0	74
A4740	RL3531QA	3531 009 001 0	209
A5000	RL1705NA01	1705 057 001 0	228
AD-IP	RL3511XE01	3511 024 001 0	37
AF103600	RL3518LE-E	3518 010 005 0	149
AF116M22J	RLD5-F008	3730 015 001 0	210
AF116M22J	RLD5-F008A	3730 015 002 0	210
AF116M22J	RLD5-F008B	3730 015 003 0	210
AF116M22R	RLD5-F007	3730 014 001 0	210
AF116M22R	RLD5-F007A	3730 014 002 0	210
AF116M22R	RLD5-F007B	3730 014 003 0	210
BFC6120,3513,030	RL3513EG01	3513 030 001 0	72
CA105A	RL3513UA01	3513 031 001 0	72
CA105D	RL3513UA02	3513 031 002 0	72
CA151	RL3512FA	3512 001 001 0	20
CA2528	RL3513FA09	3513 006 009 0	72
CA291	RL3513UA03	3513 031 003 0	72
CAS1001	RL3511HB	3513 001 005 0	40
EL13151	RL3509BX-A	3509 057 001 0	3
H26151	6250011077	6250011077	333
H-26210	6240011047	6240011047	333
H41-0101116T	3550 710 170 1	3550 710 170 1	162
H41-0401113T	3550 710 165 1	3550 710 165 1	162
HFF3550011CKAK	3550 751 148 1	3550 751 148 1	162
HJB16006-0621B.0	3550 702 194 4	3550 702 194 4	162
IA236505	RL3518GL	3518 007 024 0	143
JY3550N-012-Y	3550 710 166 1	3550 710 166 1	162
JY3550XM-014	3550 751 186 7	3550 751 186 7	162
KX3518015-10	RL3518AC	3518 001 003 0	139
LDV3662	RL3513ZA	3536 003 001 0	75
LP-3	RLD5-M026	3757 003 001 0	70
M845230	RL3519JA20	3519 030 150 0	249
MAK4000-57977000	RL2908LA06	2908 009 006 0	167
MIR12105	RL3513ZA	3536 003 001 0	75
RCCS00031	RL3509DH-D	3509 034 001 0	4
SL-4	RLD5-M022	4101 039 001 0	70
SMP5080133	RL3522YD01	3522 012 001 0	123
VG1560130080	RL3509BZ-H	3509 058 001 0	4
VS-227	RL2908LA03	2908 009 003 0	167
WA118373	RL3526ZA01	3526 035 001 0	102
WA65706	RL3522YD01	3522 012 001 0	123
WM1397JN(16859)	RL3548UA02	3548 031 001 0	230
WSK.19	RL1608EC06-9	1608 043 006 9	195
WSK.28.19C	RL1608EB05-9	1608 043 005 9	195
X3099-350	RL1704BA	1704 001 001 0	227



INDEX BY VEHICLE APPLICATIONS

ALBION									
OEM No.	Cross Ref.	SORL No.	SORL EU No	Page	OEM No.	Cross Ref.	SORL No.	SORL EU No	Page
	79546	987012810857	987012810857	320	AZ9719770051	4491420500	3550 620 055 0	3550 620 055 0	209
	79547	988012810857	988012810857	320	1425135680020		RL3549ZB01	3549 036 001 0	222
	79548	678012810107	678012810107	302	35GC2-15010		RL3515LA	3515 007 001 0	47
					WG9000360005/1		RL3514DX-D34	3514 004 322 0	89
					WG9000360108/1		RL3530BA61	3530 030 405 0	287
					WG9000360180/3		RL3522FA03	3522 004 029 0	122
					WG9000360410		RL3519JA50	3519 030 480 0	245
BMC	57RS306150	RL3519DA45	3519 090 239 0	258	WG9000360420		RL3519JA51	3519 030 481 0	245
	57RS306151	RL3519DA47	3519 090 241 0	258	WG9100360303		RL3530CA83	3530 060 597 0	273
	57RS3006140	RL3530SB13	3530 480 326 0	275	WG9100368471/4		RL3511AA	3511 003 001 0	32
	57RS3006141	RL3530SB14	3530 480 327 0	275	WG9114230018		RL1608WE04	1608 016 057 0	193
	5K91730	RL3530ZZ01	3530 870 001 0	276	WG9719230029		RL1608NZ58	1608 012 058 0	192
	9347023900	RL3515EA07	3515 003 021 0	50	13062356M0205		RL3511EK-E	3511 007 059 0	26
Falcon 1100	AE4612	RL3515XA11	3515 018 011 0	54	WG9000360523/1	9347144030	RL3515MB05	3515 008 046 0	53
Falcon 1100	LA8234	RL3511NA08	3511 014 008 0	33	WG9719360030/2		RL3526BA04	3526 004 101 0	93
						4613152670	RL3514EA01	3514 013 008 0	80
						9325000350	RL3511EQ78	3511 007 078 0	26
						4721706060	RLD5-R050	3754 012 052 0	238
BOMBARDIER					VG1560130080		RL3509BZ-H	3509 058 001 0	4
	72028	935031041255	935031041255	325					
	72030	986031040005	986031040005	296					
	72030	986031040005	986031040005	296					
BPW					DAEWOO				
02 032 73 90 0	Alternative 9253211600	RL3530CA-A58	3530 060 458 0	272		72856	929012531308	929012531308	316
02 032 75 60 0	Alternative 9254601020	RL3530PE04	3530 390 024 0	265		79416	256032530408	256032530408	315
02 032 75 60 0	BS9404	RL3530PP03	3530 390 171 0	262		79415	930032531308	930032531308	316
02 104 01 70 0	8305020684	3550 990 200 0	3550 990 200 0	160		79481	930032531308	930032531308	316
05 174 52 61 0	4335010290	6060011047	6060011047	332		79759	930032531308	930032531308	316
05 174 54 69 0	3464201738	6085612617	6085612617	331		80061	487032530418	487032530418	292
05 174 54 70 0	3464201838	6075612617	6075612617	331		80133	498111011317	498111011317	291
05 174 82 21 3		499011011217	499011011217	330					
05 444 40 01 0	1351624004	RL3530RB7	3530 451 004 0	277	DAF				
05 444 40 01 0	1351624004	RL3530RB7	3530 451 004 0	277	0066873	9700519102	RL1608PK-9	1608 044 006 0-9	196
	Alternative BS9397	RL3530QB6	3530 420 233 0	262	0066873	9700519102	RL1608PT-9	1608 047 001 0-9	196
	BS9503	RL3530CB06	3530 061 026 0	262	0110442	4341001220	RL3531WA08	3531 013 012 0	62
	H26151	6250011077	6250011077	333	0110443	4341002200	RL3531WA09	3531 013 020 0	62
	17482213	499011011207	499011011207	330	0110444	4341000240	RL3531WA02	3531 013 002 0	62
	70678	972031021107	972031021107	313	0110444	481063004000	RL3531ZA	3531 012 001 0	64
	72053	972011020207	972011020207	314	0112227	9347020400	RL3515EA10	3515 003 024 0	51
	72253	888031021307	888031021307	318	0176628	9617020010	RL3526PB	3526 008 002 0	99
	72263	888031021307	888031021307	318	0266860	4340140010	RL3525HA01	3525 008 001 0	212
	72353	888031021307	888031021307	318	0271944	9347023810	RL3515EA-H	3515 003 008 0	51
	72448	972031041097	972031041097	313	0360774	9617020080	RL3526PC	3526 008 003 0	99
	72645	999031020457	999031020457	322	0371274	9617230010	RL3526BB	3526 004 002 0	94
	72703	999031020507	999031020507	322	0375193	4613240100	RL3514DA-F	3514 012 000 0	77
	72875	999111020507	999111020507	322	0378234	4757110290	RL3523AK06	3523 002 028 0	109
	72876	999111021107	999111021107	322	0384037	AE4179	RL3515LF-F	3515 007 047 0	47
	72883	999031021507	999031021507	322	0385759	MB4636	RL3514HH	3514 008 007 0	86
	72889	999031011507	999031011507	322	0390486	9710511360	RL1608PA04	1608 044 013 0	189
	79325	999031020457	999031020457	322	0513798	9617230002	RL3526DX-9	3526 005 001 9	104
	79327	999031020507	999031020507	322	0513798	9617230002	RL3526DY-9	3526 005 002 9	104
	79502	972011020207	972011020207	314	0527486	4729001010	RL3754EC115	3754 042 115 0	177
	80019	498111020117	498111020117	291	0527487	4729000210	RL3754EC110	3754 042 110 0	176
		6050011067	6050011067	332	0527488	4729000010	RL3754EC100	3754 042 100 0	175
		6050021067	6050021067	332	0537003	4729001020	RL3754EC116	3754 042 116 0	177
					0559817	9617231080	RL3526DY	3526 005 002 0	97
					0583512	4712000080	RL3522YB03	3522 009 003 0	123
					0609715	SV3302	RL1705WA	1705 050 001 0	226
CAIWEI					0633492	4341001250	RL3531WA01	3531 013 001 0	61
WP10	612600130307	RL3509DJ-D	3509 040 001 0	2	0639394	4630131160	RL3548AG22	3548 001 022 0	223
WP6	612600130496	RL3509DJ-E	3509 041 001 0	2	0642909	4630220200	RL3548MA	3548 015 001 0	223
					0643260	4757100220	RL3523AA09	3523 001 084 0	106
					0644243	9347023800	RL3515EA-D	3515 003 005 0	51
CNHTC					0658098	9753030600	RL3512BG03	3512 007 060 0	19

INDEX BY VEHICLE APPLICATIONS

DAF

OEM No.	Cross Ref.	SORL No.	SORL EU No	Page	OEM No.	Cross Ref.	SORL No.	SORL EU No	Page
0658882	9700511020	RL1608PR	1608 045 004 0	189	1325329	9630010120	RL3520ZB	3520 501 002 0	135
0659807	9700511140	RL1608PC	1608 045 001 0	189	1325333	9710025310	RL3518ND	3527 003 004 0	132
0664867	9617221600	RL3526BK-B	3526 002 125 0	93	1325335	9710021520	RL3518MA	3527 002 001 0	133
0669714	8997605104	3550 301 815 4	3550 301 815 4	160	1325336	4640061000	RL2908AA07	2908 001 007 0	163
0691640	4613245200	RL3514DA-R	3514 012 002 0	77	1325338	4528030050	RL3521CA03	3521 006 003 0	207
0691984	9617220032	RL3526CK-9	3526 001 0119-1	104	1325339	4528050040	RL3521CD04	3521 007 004 0	207
0697317	4630630002	RL1705RA-9	1705 007 001 0-9	229	1325344	4325000210	RL3515ZB	3511 013 002 0	208
0698276	9753030012	RL3512BJ-9	3512 007 014 0-9	25	1325352	9253713000	RL3530EY15	3530 120 089 0	282
0698529	9700519042	RL1608PA-9	1608 044 001 0-9	196	1327940	622508AM	RL1608XC01	1608 050 004 0	181
0709671	4637031000	RL3506AD	3506 001 003 0	74	1337184	MB4694	RL3514HC	3514 008 002 0	86
0736144	9630010010	RL3520AC	3520 502 001 0	135	1337535	9730090012	RL3522FA-9	3522 004 001 0-9	124
0736922	4758003010	RL3523GB	3523 012 001 0	108	1346861	622508AM	RL1608XC01	1608 050 004 0	181
0802144	9730010002	RL3518AH-9	3518 001 009 0-9	154	1359971	9710023000	RL3527DF	3527 004 006 0	132
0802144	9730010002	RL3518AK-9	3518 001 013 0-9	154	1365935	4410501000	RLD5-M042	4101 099 002 0	179
0832865	9710020032	RL3518NA-9	3527 003 001 0-9	137	1379776		RL3754ES04	3754 101 004 0	238
0832865	9710020032	RL3518NB-9	3527 003 002 0-9	137	1440446	4721726860	RLD5-R057	3754 012 046 0	239
0834481	4231049000	RL3519YA1	3519 810 001 0	248	1443531	622508AM	RL1608XC01	1608 050 004 0	181
0834482	4231059000	RL3519JA18	3519 030 142 0	249	1446687	950364104	RL3527KA	3527 007 001 0	134
0867628	4324100330	RL3511AM24	3511 003 154 0	30	1450872	4410400150	RLD5-M046	3802 121 001 0	179
0867660	9347000400	RL3515HB	3515 005 002 0	57	1457275		RL3754ES03	3754 101 003 0	238
0867872	4630840000	RL3548KA	3548 018 001 0	171	1457276		RL3754ES04	3754 101 004 0	238
0867882	9630060030	RL3520ZA05	3520 501 005 0	135	1487296	9254911420	RL3530CA55	3530 060 429 0	270
0882965	4324251010	RL3511ED01	3511 021 001 0	37	1501927	9254840100	RL3530RY10	3530 452 011 0	265
0891489	4460082300	3550 625 045 0	3550 625 045 0	209	1503133	4750103070	RL3512MA09	3512 010 009 0	64
0891489	4460000000	3550 625 045 0	3550 625 045 0	209	1504901	4721950180	RL3550FA	3550 210 018 0	157
0892110	4729000300	RL3754EC112	3754 042 112 0	176	1504903	9730110500	RL3518ZA77	3518 019 077 0	141
100587	9753000140	RL3512AC	3512 006 003 0	17	1504911	9735000380	RL3516UA01	3516 022 001 0	113
106321	4220100100	RL3535FA	3535 001 001 0	220	1504917	9343000010	RL3513BB02	3536 001 008 0	74
109913		RL3521BD	3521 005 004 0	206	1504952	4528020090	RL3521CA	3521 006 001 0	207
109915		RL3521BA	3521 004 001 0	204	1504971	481064603	RL3514SA	3514 014 000 0	88
1150130	4728800640	RL3754EC301	3754 046 001 0	177	1505025	4231039000	RL3519NA	3519 360 001 0	246
1193486	4324070600	RL3754AA01	3754 042 005 0	41	1505026	4231051110	RL3519JA19	3519 030 143 0	249
1193658	4729000560	RL3754EC01	3754 042 001 0	173	1505039	4340141000	RL3525HA02	3525 008 002 0	212
1207895	0484210001	RL3754EL03	3754 045 003 0	42	1505054	4410500120	RL2908NA02	2908 013 002 0	178
1209116	MB4694	RL3514HC	3514 008 002 0	86	1505077	4630132000	RL3548NA	3548 014 001 0	223
1236573	4341000470	RL3531WA11	3531 013 036 0	62	1505078	4630132100	RL3548PA	3548 013 001 0	224
1238505	AE4437	RL3515QA04	3515 016 012 0	48	1505094	4750150010	RL3531MA24	3531 007 024 0	63
1238512	AE4443	RL3515LA17	3515 007 117 0	48	1505096	4750150310	RL3531MA	3531 007 001 0	63
1241257	622508AM	RL1608XC01	1608 050 004 0	181	1505128	9347050050	RL3515SA01	3515 011 013 0	56
1259855	9730093000	RL3522FA	3522 004 001 0	122	1505150	9730060010	RL3518AE01	3518 042 001 0	142
1259856	59520-Y3B00.2	RL3518ZE-B	3518 019 009 0	142	1505153	9735000060	RL3516EH	3516 005 006 0	113
1279601	9617230042	RL3526NA-9	3526 006 001 0-9	104	1505223	4324102500	RL3511AM30	3511 003 136 0	31
1279601	9617230042	RL3526NB-9	3526 006 002 0-9	104	1505230	9325000070	RL3511DG32	3511 006 032 0	27
1285260	4630850000	RL1705AA01	1705 015 001 0	198	1505232	4324150290	RL3511ER-B	3511 008 082 0	36
1291360		RL8606CA	8606 003 001 0	171	1505240	4231061060	RL3519AM09	3519 010 192 0	253
1291857	625218AM	RL1608XA-9	1608 049 001 0-9	194	1505241	4231047100	RL3519HA11	3519 210 107 0	243
1302096	4757111260	RL3523AK-D	3523 002 010 0	109	1505290	4729000020	RL3754EC101	3754 042 101 0	175
1302103	9730112050	RL3518ZE	3518 019 006 0	142	1505292	4729000120	RL3754EC107	3754 042 107 0	175
1302682	4729000530	RL3754EC02	3754 042 002 0	173	1505294	4729000620	RL3754EC04	3754 042 004 0	173
1303948		RL3754ES03	3754 101 003 0	238	1505296	4729001140	RL3754EC19	3754 042 019 0	175
1304587	4729000550	RL3754EC07	3754 042 007 0	173	1505331	9617230040	RL3526BA07	3526 004 155 0	93
1304635	4721950160	RL3550SM24	3550 210 024 0	157	1505334	DPM94AAX	RL3526NE	3526 006 005 0	98
1305026	9730110040	RL3518ZH	3518 019 010 0	141	1505339	9617232130	RL3526DC05	3526 005 105 0	96
1305138	4750104000	RL3512MA	3512 010 001 0	68	1505399	9347023870	RL3515EA04	3515 003 018 0	50
1305452	4729051110	RL3754EC-B	3754 044 003 0	177	1505403	9347141250	RL3515MA35	3515 008 035 0	52
1305844	4410500110	RL2908NA01	2908 013 001 0	178	1505406	9347142110	RL3515MB02	3515 008 041 0	52
1306727	4721706160	RLD5-R051	3754 012 045 0	239	1505409	9735000030	RL3516EE	3516 005 003 0	112
1315507	4721726060	RLD5-R056	3754 012 044 0	239	1505410	9730012110	RL3518AZ	3518 001 015 0	140
1315508	4721717060	RLD5-R055	3754 012 048 0	239	1505432	4722500000	RL3754PT02	3754 100 002 0	240
1315510	4721727860	RLD5-R059	3754 012 047 0	240	1505435	9254248000	RL3530YZ4	3530 241 004 0	263
1315698	4410328080	3550 301 808 0	3550 301 808 0	158	1505436	9254261000	RL3530YY1	3530 630 005 0	263
1325323	4721950200	RL3518ZC-C	3518 020 006 0	157	1505437	9254262000	RL3530YZ1	3530 241 001 0	263
1325324	4757120000	RL3523CB	3523 005 002 0	108	1505440	Alternative 9254601000	RL3530PF27	3530 390 022 0	265
1325328	9630010130	RL3520ZA	3520 501 001 0	135	1505480	9753034800	RL3512BG07	3512 007 064 0	19

Pictures And/or OEM Part Numbers are for reference purpose only.

INDEX BY VEHICLE APPLICATIONS

DAF

OEM No.	Cross Ref.	SORL No.	SORL EU No	Page	OEM No.	Cross Ref.	SORL No.	SORL EU No	Page
1505498	9325000130	RL3511DG33	3511 006 033 0	27	1518064	4613152580	RL3514EA	3514 013 000 0	80
1505867	9735000180	RL3516ET	3516 005 015 0	113	1518065	4613152640	RL3514EC	3514 013 004 0	81
1505965	4324100830	RL3511AM01-A	3511 003 143 0	30	1518067	4613190080	RL3514DD	3514 004 003 0	77
1505967	4324101020	RL3511AM	3511 003 025 0	28	1518069	4613192500	RL3514EB-A	3514 013 003 0	81
1505970	4324102202	RL3511KC	3513 001 003 0	40	1518070	4613192710	RL3514EB	3514 013 002 0	81
1505972	4324200000	RL3511AZ	3511 003 036 0	29	1518073	4614911020	RL3514ME11	3514 009 011 0	82
1505978	4324310022	RL3511FA-9	3511 009 101 9	45	1518075	4614945020	RL3514XD01	3514 022 001 0	87
1506005	4410329212	3550 305 808 0	3550 305 808 0	159	1518078	4630131140	RL3548AG	3548 001 003 0	223
1506006	4410329222	3550 305 809 0	3550 305 809 0	159	1518085	4630370010	RL1705UA	1705 009 001 0	224
1506007	4410329632	3550 307 003 0	3550 307 003 0	159	1518090	4630630020	RL1705RB	1705 007 002 0	226
1506025	4460083902	3550 625 045 8	3550 625 045 8	209	1518092	4630840300	RL8606HA	8606 009 001 0	172
1506066	4522000000	RL3521BB01	3521 005 021 0	205	1518099	4700120000	RL3514MF	3514 009 003 0	83
1506071	4528020032	RL3521CA-9	3521 006 001 9	207	1518108	4729000500	RL3754EC120	3754 042 120 0	176
1506081	4613072000	RL3514MA	3514 009 000 0	82	1518110	4729051140	RL3754EB-B	3754 044 002 0	177
1506089	4613170000	RL3514DX-D	3514 004 078 0	78	1518116	4750103170	RL3512MA22	3512 010 022 0	66
1506092	4613192600	RL3514EB-B	3514 013 006 0	81	1518117	4750103250	RL3512MA29	3512 010 029 0	67
1506104	4630360050	RL1705CB	1705 003 002 0	224	1518121	4757100200	RL3523AB-D	3523 001 024 0	108
1506107R	4630840117	RL3548KB	3548 018 002 0	172	1518127	4757120040	RL3523CA	3523 005 001 0	108
1506114	4640060000	RL2908AB	2908 001 002 0	163	1518145	Alternative 9253211600	RL3530CA-A58	3530 060 458 0	272
1506180	4729000600	RL3754EC03	3754 042 003 0	173	1518146	9253212020	RL3530CA93	3530 060 907 0	273
1506181	4729000610	RL3754EC09	3754 042 009 0	173	1518149	9253221550	RL3530SB11	3530 480 221 0	275
1506182	4729001130	RL3754EC18	3754 042 018 0	175	1518150	9253224230	RL3530SB12	3530 480 222 0	276
1506228	9254860100	RL3530SY1	3530 240 001 0	263	1518153	9254241000	RL3530RA16	3530 450 040 0	268
1506232	4757155000	RL3523BB	3523 005 004 0	110	1518154	9254248010	RL3530YZ5	3530 241 005 0	263
1506272	9254860110	RL3530SY2	3530 240 002 0	263	1518156	9254500047	RL3530PF01	3530 301 001 0	270
1506400	Alternative 9254601020	RL3530PE04	3530 390 024 0	265	1518162	9254645010	RL3530RY8	3530 452 008 0	265
1506401	9254610010	RL3530CA36	3530 060 172 0	267	1518170	9325000140	RL3511DG31	3511 006 031 0	27
1506403	9254644520	RL3530YZ9	3530 241 009 0	264	1518174	9347020410	RL3515EA09	3515 003 012 0	50
1506421	9500600030	RL3513FC	3513 006 004 0	73	1518176	9347020820	RL3515EA03	3515 003 017 0	50
1506423	9500800020	RL3513WA01	3513 009 001 0	73	1518178	9347022100	RL3515DA	3515 002 001 0	49
1506435	9522000210	RL3521BB-A	3521 005 002 0	205	1518179	9347022210	RL3515DA05	3515 002 005 0	49
1506443	9617210040	RL3526VB	3526 020 002 0	99	1518180	9347022400	RL3515DA06	3515 002 006 0	49
1506448	9630010510	RL3520ZD02	3520 504 002 0	136	1518181	9347022600	RL3515WA01	3515 017 001 0	49
1506449	9630010520	RL3520ZD01	3520 504 001 0	136	1518184	9347023200	RL3515EA-B	3515 003 003 0	51
1506456	9700511580	RL1608LB	1608 041 001 0	185	1518185	9347023220	RL3515EA01	3515 003 010 0	50
1506458	9700511740	RL1608PA02	1608 044 010 0	190	1518186	9347023400	RL3515EA-C	3515 003 004 0	51
1506459	9700511760	RL1608PA05	1608 044 014 0	190	1518191	9347141190	RL3515MB01	3515 008 017 0	52
1506460	9700511830	RL1608PT	1608 047 001 0	190	1518192	9347141230	RL3515MB04	3515 008 045 0	53
1506465	9700514120	RL1608EA15	1608 042 052 0	186	1518206	9522010010	RL3521EA02	3521 014 002 0	206
1506466	9700514230	RL1608EE	1608 042 002 0	187	1518221	9617222120	RL3526RA	3526 010 001 0	96
1506467	9700514240	RL1608EA09	1608 042 021 0	186	1518229	9617230050	RL3526NA-B	3526 006 009 0	98
1506472	9710020042	RL3518MA-9	3527 002 001 9	137	1518233	9617231000	RL3526DX07	3526 005 051 0	97
1506475	9710020062	RL3518NC-9	3527 003 003 0-9	138	1518234	9617231020	RL3526DC	3526 005 003 0	96
1506508	4729001100	RL3754EC16	3754 042 016 0	174	1518235	9617231040	RL3526NB	3526 006 002 0	98
1506643	9710021500	RL3518NB	3527 003 002 0	133	1518236	9617231110	RL3526DX03	3526 005 018 0	97
1506757	9617232170	RL3526XB03	3526 041 003 0	100	1518244	9700511240	RL1608PE	1608 053 001 0	191
1506783	4613150420	RL3514DS-E	3514 004 052 0	78	1518245	9700511260	RL1608PQ	1608 045 003 0	189
1517296	9254880100	RL3530YX10	3530 690 015 0	264	1518246	9700511280	RL1608PE02	1608 053 003 0	191
1517493	4757111550	RL3523AK04	3523 002 026 0	109	1518247	9700511310	RL1608KA	1608 039 001 0	185
1517895	4750150040	RL3531MA06	3531 007 006 0	63	1518249	9700511370	RL1608PK	1608 044 006 0	190
1517913	4613240160	RL3514DA-G	3514 012 001 0	77	1518250	9700511510	RL1608PS	1608 048 001 0	188
1517931	4110345010	RL3509AA	3509 001 001 0	1	1518251	9700511570	RL1608PA06	1608 044 016 0	188
1517945	4220100120	RL3535FA02	3535 002 002 0	220	1518252	9700511590	RL1608LB-A	1608 041 002 0	185
1517946	4220100140	RL3535GA	3535 002 001 0	221	1518254	9700512090	RL1608PF	1608 046 001 0	191
1517954	4235050000	RL3519JA22	3519 030 267 0	244	1518257	9710020000	RL3518NC	3527 003 003 0	133
1517962	4324070150	RL3511EF02	3511 007 007 8	41	1518259	9710023070	RL3527DB	3527 004 002 0	131
1517967	4324101130	RL3511AM02	3511 003 097 0	28	1518260	9710025700	RL3518NF	3527 003 006 0	133
1517968	4324101150	RL3511AM04	3511 003 099 0	29	1518270	9730112060	RL3518ZA07	3518 019 060 0	141
1517969	4324101170	RL3511AM03	3511 003 098 0	29	1518272	9735000110	RL3516EG	3516 005 005 0	113
1517973	4324200020	RL3511AZ-A	3511 003 037 0	29	1518273	356013011	RL3516TA	3516 015 001 0	118
1517975	4324210020	RL3511AM05	3511 003 100 0	29	1518280	9753030710	RL3512BG01	3512 007 058 0	19
1517987	4342050320	RL3548UB01	3548 038 001 0	222	1518281	9753030800	RL3512BG02	3512 007 059 0	19
1518057	4613074390	RL3514MD	3514 009 005 0	82	1518286	9753035030	RL3512BG06	3512 007 063 0	19
1518060	4613150080	RL3514DS	3514 004 025 0	78	1518287	9753035040	RL3512BG04	3512 007 061 0	19

INDEX BY VEHICLE APPLICATIONS

DAF

OEM No.	Cross Ref.	SORL No.	SORL EU No	Page	OEM No.	Cross Ref.	SORL No.	SORL EU No	Page
1518674	4324100340	RL3511AM26	3511 003 156 0	31	675644		RL3523AB-F	3523 001 036 0	107
1518678	4324101160	RL3511AM10	3511 003 130 0	29	68409	MB4629	RL3514HA	3514 008 000 0	85
1518680	LA6200	RL3511CH-A	3511 005 006 0	32	691984	9617220032	RL3526RB-9	3526 010 0029-1	104
1518793	4613180470	RL3514DX-D39	3514 004 539 0	79	736924	4721271400	RLD5-R061	3754 055 001 0	240
1518794	4613180490	RL3514DX-D05	3514 004 300 0	79	762788	9115040520	RL3509BJ	3509 010 001 0	4
1518800	4613190072	RL3514DD-9	3514 004 003 0-9	91	815808	9710025300	RL3518NA	3527 003 001 0	132
1518803		RL3514ED	3514 013 005 0	81	F2100	Alternative 9254921020	RL3530SB19	3530 480 098 0	275
1518851	4630360160	RL1705CA08	1705 003 008 0	224	F3600	Alternative 9254921020	RL3530SB19	3530 480 098 0	275
1518856	SV1318	RL2908CB	2908 003 002 0	164	FBU5577	4757140002	RL3523AK-C-9	3523 002 008 9	111
1518917	4729000630	RL3754EC12	3754 042 012 0	174		03342-56000	RL3516DA	3516 004 001 0	116
1518918	4729001120	RL3754EC17	3754 042 017 0	175		10868	254031031507	254031031507	311
1518928	4750100090	RL3531NB	3531 008 002 0	63		10869	255031031507	255031031507	312
1518952	4757101210	RL3523AB02	3523 001 102 0	107		1362430001	RL3530EY21	3530 120 144 0	283
1518960	4757110240	RL3523AK-B	3523 002 007 0	109		2430GCMEXLS	RL3530EY14	3530 120 087 0	282
1518974	4757120002	RL3523CA-9	3523 005 0019-1	111		4005000810 w/o 4461080860	RL3518SU01	3518 030 001 0	156
1519201	9324000002	RL3511DH-9	3511 006 009 0-9	44		4324100350	RL3511AM35	3511 003 198 0	31
1519205	9347020012	RL3515EA-B-9	3515 003 003 0-9	58		4324100750	RL3511AM37	3511 003 200 0	31
1519209	9347023020	RL3515EA05	3515 003 019 0	50		4324100760	RL3511AM36	3511 003 199 0	31
1505157	9753001100	RL3512AB	3512 006 002 0	17		4324200030	RL3511AZ-B	3511 003 038 0	29
1519548	9349010052	RL3515DA-9	3515 002 001 0-9	58		4613186040	RL3514DX-D06	3514 004 400 0	79
1519548	9349010052	RL3515KB-9	3515 006 002 0-9	58		4613192740	RL3514EA03	3514 013 017 0	81
1519192	Alternative 9254601010	RL3530PE02	3530 390 023 0	265		4640070190	RL2908GA07	2908 007 007 0	165
1519198	9254680100	RL3530YX1	3530 690 001 0	264		4640070300	RL2908GA19	2908 007 019 0	165
1519266	9617231250	RL3526XC01	3526 042 001 0	100		4720174800	RL8606JA	8606 011 001 0	211
1519269	9617232080	RL3526DX06	3526 005 100 0	97		4721710000	RLD5-R053	3754 012 037 0	239
1519286	9700514380	RL1608HA10	1608 090 010 0	188		4750103100	RL3512MA12	3512 010 012 0	65
1519290	9700519162	RL1608LB-9	1608 041 110 9	194		4750103150	RL3512MA20	3512 010 020 0	66
1519290	9700519162	RL1608LB-A-9	1608 041 002 9	194		4750103160	RL3512MA21	3512 010 021 0	66
1519291	9700519442	RL1608PJ-9	1608 044 005 0-9	196		4750103190	RL3512MA24	3512 010 024 0	66
1519292	9700519492	RL1608EC-9	1608 043 001 0-9	195		4750103200	RL3512MA25	3512 010 025 0	66
1519296	9710021510	RL3518MB	3527 002 002 0	133		4750103210	RL3512MA26	3512 010 026 0	66
1519300	9710023040	RL3527DA	3527 004 001 0	131		4750103220	RL3512MA27	3512 010 027 0	67
1519305	9710025470	RL3518NE	3527 003 005 0	132		4750103230	RL3512MA28	3512 010 028 0	67
1519310	9710027000	RL3527DD	3527 004 004 0	132		4750103260	RL3512MA30	3512 010 030 0	67
1519312	9710027010	RL3527DE	3527 004 005 0	132		4750103290	RL3512MA32	3512 010 032 0	67
1519318	9730020000	RL3522AZ13	3522 001 013 0	121		4750103340	RL3512MA37	3512 010 037 0	68
1519332	9730112010	RL3518ZA01	3518 019 020 0	142		4757100060	RL3523AB10	3523 001 110 0	107
1519378	9254810120	RL3530CA53	3530 060 427 0	267		4757101360	RL3523AB-L	3523 001 157 0	108
1519548	9347022500	RL3515KE	3515 006 002 0	49		622785AM	RL1608XA	1608 049 001 0	181
1523676	9254262010	RL3530YZ2	3530 241 002 0	263		70513	678031031105	678031031105	301
1523999	4729051160	RL3754EC-C	3754 044 005 0	177		70823	678031031117	678031031117	301
1524015	4750150630	RL3531MA08	3531 007 008 0	63		70824	254031031107	254031031107	311
1524289	9617222320	RL3526RB	3526 010 002 0	96		70825	255031031107	255031031107	312
1524294	DPM95AAX	RL3526NE-A	3526 006 008 0	98		70871	986031030307	986031030307	296
1524300	9617210070	RL3526VA	3526 020 001 0	99		72011	678031021107	678031021107	301
1524310	9617230190	RL3526NA	3526 006 001 0	98		72107	254021031557	254021031557	311
1524500	9254880150	RL3530YX9	3530 690 013 0	264		72108	255021031557	255021031557	312
1524857	9347140100	RL3515MA	3515 008 001 0	52		72117	986021033397	986021033397	296
1525422	4728800640	RL3754EC301	3754 046 001 0	177		72197	678021033397	678021033397	302
1525456	4722500030	RL3754PT01	3754 100 001 0	240		72202	986021031557	986021031557	296
1525765	9254880140	RL3530YX8	3530 690 012 0	264		72309	986011030007	986011030007	296
1607416	AE4528	RL3515AH10	3515 023 010 0	57		72312	231011030837	231011030837	303
1607417	AE4529	RL3515AH11	3515 023 011 0	57		72313	232011030837	232011030837	303
1612053	AE4526	RL3515AH08	3515 023 008 0	56		72523	254021021557	254021021557	311
1619672	4342080300	RL3533LB22	3533 009 022 0	218		72524	255021021557	255021021557	312
1624254	4721950410	RL3518ZZ	3518 020 003 0	156		72525	254021023397	254021023397	311
1664345	9710028050	RL3527DE07	3527 004 007 0	132		72526	255021023397	255021023397	312
223439	4750103130	RL3512MA15	3512 010 015 0	65		72527	232012620837	232012620837	303
271944	AE4179	RL3515LF-F	3515 007 047 0	47		72530	986021023397	986021023397	296
285768	9753034740	RL3512BK	3512 007 015 0	18		72532	970021021557	970021021557	309
355034014	8997598154	3550 301 510 4	3550 301 510 4	159		72533	971021021557	971021021557	310
374642	9617222520	RL3526CK	3526 001 011 0	95		72534	678021023397	678021023397	302
504507	9347020000	RL3515EA06	3515 003 020 0	50		72535	986021021557	986021021557	296
658098	9753000140	RL3512AC	3512 006 003 0	17		72538	931011020407	931011020407	298

Pictures And/or OEM Part Numbers are for reference purpose only.

INDEX BY VEHICLE APPLICATIONS

DAF

OEM No.	Cross Ref.	SORL No.	SORL EU No	Page
	72539	932011020407	932011020407	298
	72540	986021023407	986021023407	296
	72541	986011020007	986011020007	296
	72544	231011020837	231011020837	303
	72545	232011020837	232011020837	303
	72547	986011020407	986011020407	296
	72550	678021021557	678021021557	302
	72558	986051021807	986051021807	296
	72586	254021020007	254021020007	311
	72587	255021020007	255021020007	312
	72608	270021023397	270021023397	328
	72695	231011020377	231011020377	303
	72696	232011020377	232011020377	303
	72815	254031050757	254031050757	311
	72816	255031050757	255031050757	312
	72917	254031021107	254031021107	311
	72918	255031021107	255031021107	312
	78964	RL3513EF01	3513 500 001 0	41
	79156	970021051555	970021051555	309
	79167	923011020707	923011020707	324
	79168	924011020707	924011020707	324
	79578	924011021207	924011021207	324
	92528	RL3513EF01	3513 500 001 0	41
	Alternative 9254601030	RL3530PE05	3530 390 025 0	265
	Alternative 9254601040	RL3530PE06	3530 390 026 0	265
	Alternative 9254601050	RL3530PE07	3530 390 027 0	265
	Alternative 9254601070	RL3530PE08	3530 390 028 0	265
	Alternative 9254601080	RL3530PE03	3530 390 029 0	265
	Alternative 9254601090	RL3530PE09	3530 390 030 0	265
	93522	RL3513EF01	3513 500 001 0	41
	9617222750	RL3526CK04	3526 001 110 0	95
	9617231220	RL3526XB01	3526 041 001 0	100
	9630010500	RL3520ZD03	3520 504 003 0	136
	9700511000	RL1608PC-A	1608 044 033 0	189
	9700519032	RL1608KA-9	1608 039 001 0-9	194
	9700514130	RL1608EF	1608 042 003 0	187
	9730025000	RL3522BB	3522 002 002 0	121
	9730025060	RL3522BB	3522 002 002 0	121
	9753031690	RL3512BG08	3512 007 065 0	20
	AC577A	RL3518AC01	3518 035 001 0	143
	Alternative BS9404	RL3530PE77	3530 390 178 0	262
	Alternative BS9404	RL3530PP02	3530 390 156 0	262
		RL3530CB24	3530 060 912 0	262
	HB1142	RL3526QL02	3526 030 002 0	100
		RL3530CB24	3530 060 912 0	262
	KB2725	948021021437	948021021437	300
	KB2730	947021021437	947021021437	300
	SV1281	RL2908DA05	2908 004 005 0	165
	SV3111	RL8606GA	8606 008 001 0	171
		CM2XL-4SC1	CM2XL-4SC1	156
		CM3XL-4SC1	CM3XL-4SC1	156
		RL1608EA03	1608 042 010 0	186
		RL1608EA05	1608 042 012 0	186
		RL1608XB	1608 050 001 0	181
		RL1608XC07	1608 050 031 0	182
		RL3530GA	3530 180 001 0	283
DANA				
	70893	254031050755	254031050755	311
	70894	255031050755	255031050755	312
	72144	972021053395	972021053395	314
	72189	678031040765	678031040765	301
	72190	678031040735	678031040735	301

OEM No.	Cross Ref.	SORL No.	SORL EU No	Page
	72575	678031040745	678031040745	301
	79071	972021050635	972021050635	314
DENNIS				
613722	4758003010	RL3523GB	3523 012 001 0	108
DP002130	9730060010	RL3518AE01	3518 042 001 0	142
R Series	LA8050	RL3511NA25	3511 014 043 0	34
	AE4612	RL3515XA11	3515 018 011 0	54
	10937	254021030005	254021030005	311
	10938	255021030005	255021030005	312
	70859	678031050755	678031050755	301
	70986	678021051605	678021051605	301
	72145	678031040155	678031040155	301
	72147	254031050505	254031050505	311
	72148	255031050505	255031050505	312
	72333	678031020165	678031020165	302
	72362	678031030155	678031030155	301
	72363	256031040155	256031040155	315
	72364	678021033415	678021033415	302
	72367	678031030165	678031030165	302
	72393	678031030755	678031030755	301
	72425	678031020755	678031020755	301
	72457	678031050755	678031050755	301
	72644	678021033405	678021033405	302
	79157	971021051555	971021051555	310
DONGFENG				
3527D2-010	EQ153	RL3518BA	3518 002 001 0	152
	1608Z60-001	RL1608FA	1608 011 001 0	192
	3512N-010-B	RL3512BC	3512 007 003 0	18
	3519001-BQ01D	RL3519HB01	3519 210 119 0	243
	3519002-BQ01D	RL3519HB02	3519 210 120 0	243
	3519010J-0A2200	RL3519DA75	3519 090 320 0	246
	3519JS15A-001	RL3519JA45	3519 030 203 0	245
	3519JS15A-002	RL3519JA46	3519 030 204 0	245
	3519NP15-010	RL3519AM38	3519 010 312 0	246
	3519NP15-015	RL3519AM39	3519 010 313 0	246
	3519NS28W-010	RL3519JA48	3519 030 364 0	244
	3519NS28W-015	RL3519JA49	3519 030 365 0	244
	3519VS04A-001	RL3519HA27	3519 210 053 0	243
	3519VS04A-002	RL3519HA28	3519 210 054 0	243
	3530010-XP100	RL3530CA-X	3530 060 305 0	267
	3530015-XP100	RL3530CA-Y	3530 060 306 0	267
	3530FS50-001	RL3530PE40	3530 390 040 0	266
	3530FS50-002	RL3530PE41	3530 390 041 0	266
	79646	678011020366	678011020366	302
	79618	678031021306	678031021306	302
	79617	678031030406	678031030406	302
		RL3548UA01	3548 030 001 0	228
		RL3521BC-B	3521 004 012 0	205
EATON				
A7313		RLD5-Z138	1705 530 001 0	201
A7315		RLD5-Z137	1705 529 001 0	201
A7318		RLD5-Z136	1705 528 001 0	201
	11029	678031031005	678031031005	301
	72278	888031021305	888031021305	318

INDEX BY VEHICLE APPLICATIONS

EVOBUS

OEM No.	Cross Ref.	SORL No.	SORL EU No	Page
8.025.172.000	338021001	RL8606EA	8606 005 001 0	171
8.283.220.000	4522000000	RL3521BB01	3521 005 021 0	205
8.283.706.000	9630010010	RL3520AC	3520 502 001 0	135
8.283.789.000	4730170050	RL3518KM	3518 009 025 0	139
8.285.434.000	4613170510	RL3514DY	3514 004 036 0	80
8.285.537.000	4324101040	RL3511AM-A	3511 003 026 0	28
	0481026303000	RL3518AD01	3518 036 001 0	142
	4757101360	RL3523AB-L	3523 001 157 0	108

FAUN

1614170	9347020400	RL3515EA10	3515 003 024 0	51
99707006463	4750103060	RL3512MA08	3512 010 008 0	64
99707307392	8942600492	K2432	3511 012 005 0	42

FAW

3515010-Q395	9325000350	RL3511EQ78	3511 007 078 0	26
3518010-348		RL3518ZD	3518 019 005 0	142
3518010-418		RL3518ZD	3518 019 005 0	142
CA151		RLD5-M018	4101 037 001 0	70
CA151		RLD5-M040	4101 501 016 0	70
CA6DL	3509010-671-0382	RL3509CA02	3509 009 002 0	2
J6		RL3549JA	3549 008 001 0	222
Qingdao	QT50CQK2-3519010	RL3519JA52	3519 030 489 0	244
Qingdao	QT50CQK2-3519020	RL3519JA53	3519 030 490 0	244
Sailong	3523010-50A	RL3549FK02	3549 007 003 0	222
Sailong Truck	3518020-D828	RL3518ZC01	3518 020 023 0	157
	3508815-Q109C	RL3526DE	3526 005 005 0	97
	3508915-240	RL3526BA09	3526 004 130 0	94
	3514010-K1H	RL3514AF	3514 001 007 0	77
	3519010-01L	RL3519AM35	3519 010 230 0	245
	3519010-01R	RL3519AM36	3519 010 231 0	245
	CA151	RL3512FA	3512 001 001 0	20
		RL3514AG	3514 001 005 0	77
		RL3526DD	3526 005 004 0	96

FODEN

Alpha	AC577A	RL3518AC01	3518 035 001 0	143
	10274	970021053395	970021053395	309
	10275	971021053395	971021053395	310
	12132	353052833405	353052833405	295
	70859	678031050755	678031050755	301
	72069	231012631017	231012631017	303
	72070	232012631017	232012631017	303
	72180	353052833555	353052833555	295
	72181	986052833555	986052833555	296
	72199	353052833255	353052833255	295
	72393	678031030755	678031030755	301
	72417	970021053395	970021053395	309
	72418	971021053395	971021053395	310
	72425	678031020755	678031020755	301
	72457	678031050755	678031050755	301
	72864	986052833405	986052833405	297
	72937	231012631017	231012631017	303
	72938	232012631017	232012631017	303
	79169	256031040015	256031040015	315
	79184	353022830755	353022830755	295
	79349	979061040437	979061040437	308
	79350	978061040437	978061040437	308
	79353	353031410146	353031410146	295
	79461	986022830755	986022830755	297
	79682	986052833557	986052833557	296

FODEN

OEM No.	Cross Ref.	SORL No.	SORL EU No	Page
	AE4534	RL3515AH12	3515 023 012 0	57
QT469S4-3530030 left	Alternative BS8508	RL3530CB01	3530 061 048 0	262
QT469S4-3530030 right	Alternative BS8508	RL3530CB02	3530 060 838 0	262
		RL3523FJ	3523 006 002 0	110

FORD

2C452A270AD	4613151560	RL3514DX-D03	3514 004 200 0	79
86015528	9617210040	RL3526VB	3526 020 002 0	99
B1618	4613150570	RL3514DX-D35	3514 004 452 0	80
B1618	9730010190	RL3518AH02	3518 001 057 0	140
C1514	9730010190	RL3518AH02	3518 001 057 0	140
	280375	RL3518EA2	3518 005 006 0	130
	4324200030	RL3511AZ-B	3511 003 038 0	29
	4613151570	RL3514DX-D41	3514 004 603 0	79
	AE4168	RL3515LF-A	3515 007 030 0	46
	II38201	RL3512CB02	3512 008 002 0	20

FOTON

Auman	1115035600033	RL3518KA02	3518 009 044 0	139
Auman	1338135601050	RL3518FZ	3518 006 001 0	153
Auman	1417035500003	RL3514DW	3514 004 042 0	89
Auman	1424135641001	RL3549BB01	3549 002 010 0	222
Auman Dump	1425324000001	RL3530DZ1	3530 090 005 0	274
Auman Dump	1425324000011	RL3530DZ2	3530 090 012 0	274
Ollin	1104335600149	RL3512BU	3512 007 025 0	20
Ollin	1104335900027	RL3514DX-D02	3514 004 139 0	89
Ollin	1104935600188	RL3523AA07	3523 001 066 0	106
Ollin	1106635615001	RL3515KA	3515 006 001 0	49
Ollin	1106935000004	RL3549JL01	3549 010 007 0	222
Ollin	F5815356X0055	RL3516AA	3516 001 001 0	113
Rowor	13032356M0087	RL3518BA57	3518 002 057 0	153
Rowor	13042162M0111	RL1608GK01	1608 007 019 0	192
Rowor	13042356M0187	RL3512BA-C	3512 007 031 0	18
Rowor	13053357X0007	RL3526BM	3526 004 012 0	95
Rowor	13062353M0055	RL3526BA02	3526 004 042 0	94
Rowor	13062356M0205	RL3511EK-E	3511 007 059 0	26
Rowor	13072162X0034	RL1608GK	1608 007 008 0	192
Rowor	13072350M0088	RL3549JL02	3549 010 009 0	222
Rowor	13076356X0168	RL3518BC-L	3518 002 030 0	153
Rowor	13082356M0005	RL3515KE02	3515 006 026 0	49
Rowor	13118356X0024	RL3511EU	3511 008 005 0	32
Rowor	13137356X0003	RL3515KD	3515 006 004 0	49
Rowor	13102356M0041	RL3518TK01	3518 050 002 0	153
Rowor	F5820350X0009	RL3549JL03	3549 010 022 0	222
	1315035300005	RL3526BA	3526 004 001 0	93
	14096353X0002	RL3526NA-C	3526 006 006 0	98
	1417035600070	RL3511AF	3511 003 018 0	31
	1417035600091	RL3518AA	3518 001 001 0	153
	1425135680020	RL3549ZB01	3549 036 001 0	222
	8845019220	RL3526XA02	3526 040 002 0	100
	8845021050	RL3526BK01	3526 002 123 0	94
	9325000350	RL3511EQ78	3511 007 078 0	26
		RL3511EF	3511 007 007 0	26
	9347144030	RL3515MB05	3515 008 046 0	53
	3527AD-010	RL3518AA	3518 001 001 0	153
	F5815359X0004	RL3514DA	3514 004 000 0	89
	KX3518015-10	RL3518AC	3518 001 003 0	139
		RL3515PA	3515 010 001 0	53
		RL3515PA-P	3515 010 001 0-9	58
		RL3519DB-C	3519 120 030 0	254

INDEX BY VEHICLE APPLICATIONS

FOTON									
OEM No.	Cross Ref.	SORL No.	SORL EU No	Page	OEM No.	Cross Ref.	SORL No.	SORL EU No	Page
		RL3519DB-D	3519 120 031 0	254		72778	986011030228	986011030228	296
		RL3526XA01	3526 040 001 0	100		72779	353011033528	353011033528	295
						72856	929012531308	929012531308	316
						72857	930012531308	930012531308	316
						72858	256012530408	256012530408	315
						80301	496102511507	496102511507	294
						9347141520	RL3515MB03	3515 008 044 0	53
FRUEHAUF					IKARUS				
	12142	255031021307	255031021307	312		313002	RL3529BA	3511 010 001 0	43
	70842	972031021405	972031021405	314		LA1100	RL3529AA	3511 011 001 0	43
	70854	972013720107	972013720107	314	Bus	LA8008	RL3511NA02	3511 014 005 0	33
	70959	972013721007	972013721007	314	Bus	LA8044	RL3511NA24	3511 014 042 0	34
	70979	972033740005	972033740005	313					
	72031	972031040035	972031040035	313					
	72103	972031043597	972031043597	313					
	72115	972031040605	972031040605	314					
	80021	498113710317	498113710317	291					
FULLER					ISUZU				
A6909		RLD5-Z110	1705 502 013 0	199	1-48350-059		RL3512LA	3512 004 001 0	24
A6910		RLD5-Z111	1705 502 014 0	199	1-48350-058		RL3512LA-A	3512 004 002 0	24
A7313		RLD5-Z138	1705 530 001 0	201	1-48460-145-0		RL3548FC	3548 006 003 0	232
A7315		RLD5-Z137	1705 529 001 0	201	1-48460-198-0		RL3548FB	3548 006 002 0	232
A7318		RLD5-Z136	1705 528 001 0	201		17600B	RL3548GB	3548 007 002 0	237
A4900		RLD5-Z128	1705 520 001 0	201		642-03179	RL1608AM02	1608 001 081 0	183
A5010		RLD5-Z129	1705 521 001 0	201		642-09004	RL1608AN01	1608 051 003 0	183
						642-09102	RL1609BY02	1608 052 004 0	184
						80200	475102430217	475102430217	293
						KA625559	RL1608XC03	1608 050 017 0	182
HINO					IVECO				
32210-1600	642-09408	RL1608DA02	1608 005 038 0	185	00000668	9730020000	RL3522AZ13	3522 001 013 0	121
32210-1601	642-09408	RL1608DA02	1608 005 038 0	185	01135961	4341002200	RL3531WA09	3531 013 020 0	62
47160-2452		RL3514NB	3514 011 001 0	88	01260634	9343000010	RL3513BB02	3536 001 008 0	74
ZM440		RL3530MA01	3530 330 107 0	275	02470415	4614911020	RL3514ME11	3514 009 011 0	82
	10283	929031921355	929031921355	316	02494268	9347020410	RL3515EA09	3515 003 012 0	50
	12254	254031921355	254031921355	311	02516823	4341001220	RL3531WA08	3531 013 012 0	62
	12255	255031921355	255031921355	312	02516827	4341000240	RL3531WA02	3531 013 002 0	62
	12256	256031920005	256031920005	315	02516892	0481039221000	RL3512NA	3512 014 001 0	19
	17600B	RL3548GB	3548 007 002 0	237	02516914	9347020400	RL3515EA10	3515 003 024 0	51
	23500-1010	RL3529EA	3529 001 001 0	17	02516892	9753001100	RL3512AB	3512 006 002 0	17
	44080-1010	RL3533GB	3533 005 001 0	215	02516923	9753034640	RL3512BG	3512 007 007 0	18
	44510-1090	RL3525YB	3525 005 002 0	214	02517784	9753034800	RL3512BG07	3512 007 064 0	19
	44510-1190	RL3525FA	3525 004 001 0	214	02564591	4630131160	RL3548AG22	3548 001 022 0	223
	44530-1330	RL3512JA	3512 003 001 0	23	02968407	5710031040	RL1705BA	1705 012 001 0	225
	44530-1030	RL3513EA	3536 004 001 0	75	02968774	9730010002	RL3518AH-9	3518 001 009 0-9	154
	44540-1010	RL3518RA	3518 013 001 0	152	02980732	9753000002	RL3512AB-9	3512 006 102 9	25
	4721706060	RLD5-R050	3754 012 052 0	238	02981151	4220100100	RL3535FA	3535 001 001 0	220
	47930-1070	RL3548HB	3548 008 002 0	237	03350313	4522000000	RL3521BB01	3521 005 021 0	205
	642-03080	RL1608AM	1608 001 014 0	184	03423571	4637031000	RL3506AD	3506 001 003 0	74
	642-03502	RL1608BM	1608 003 019 0	184	042535024	AE4502	RL3515AH03	3515 023 003 0	56
	642-09102	RL1609BY02	1608 052 004 0	184	04456618	4750103130	RL3512MA15	3512 010 015 0	65
	670046	RL1704DA	1704 004 001 0	227	04457300	4750150040	RL3531MA06	3531 007 006 0	63
	S4457-01330	RL3515XB01	3515 019 001 0	51	04464164	9730010200	RL3518AK	3518 001 013 0	140
	S4457-01331	RL3515XB02	3515 019 002 0	51	04672022	4730170080	RL3518KA-A	3518 009 032 0	139
		RL3514NB-9	3514 011 001 0-9	92	04675513	SV1318	RL2908CB	2908 003 002 0	164
		RL1608AN02	1608 051 002 0	183	04676011	4750100090	RL3531NB	3531 008 002 0	63
		RL1608BM01	1608 003 062 0	183	04700994	9753030800	RL3512BG02	3512 007 059 0	19
		RL3525FB	3525 004 002 0	214	04720937	9347020820	RL3515EA03	3515 003 017 0	50
		RL3525YA	3525 005 001 0	214	04773981		RL3522BK-A	3522 002 013 0	122
					04773986	9730025210	RL3522BJ-A	3522 002 011 0	122
					04775057	4613180490	RL3514DX-D05	3514 004 300 0	79
					04776623	9700511020	RL1608PR	1608 045 004 0	189
					04780200	4750150310	RL3531MA	3531 007 001 0	63

INDEX BY VEHICLE APPLICATIONS

IVECO

OEM No.	Cross Ref.	SORL No.	SORL EU No	Page	OEM No.	Cross Ref.	SORL No.	SORL EU No	Page
04783981	4613150080	RL3514DS	3514 004 025 0	78	41035633	9522000210	RL3521BB-A	3521 005 002 0	205
04789811	9347023020	RL3515EA05	3515 003 019 0	50	41200718	4410400150	RLD5-M046	3802 121 001 0	179
04823437	4324070600	RL3754AA01	3754 042 005 0	41	41211254	ZB4587	RL3511XB04	3511 027 001 0	26
04853325	4640060010	RL2908AD	2908 001 004 0	163	41211384	ZB4587	RL3511XB04	3511 027 001 0	26
0504103066	9700514380	RL1608HA10	1608 090 010 0	188	41285078	ZB4587	RL3511XB04	3511 027 001 0	26
08120458	4730170050	RL3518KM	3518 009 025 0	139	41822694	9617210040	RL3526VB	3526 020 002 0	99
08122059	4758003010	RL3523GB	3523 012 001 0	108	42017083	9617020010	RL3526PB	3526 008 002 0	99
08124486	9630060002	RL3520ZB-9	3520 501 002 0-9	138	42037229	9700511260	RL1608PQ	1608 045 003 0	189
08124505	9753030012	RL3512BG-9	3512 007 007 0-9	25	42037766	9700511260	RL1608PQ	1608 045 003 0	189
08160464	4324100330	RL3511AM24	3511 003 154 0	30	42061639	8997605104	3550 301 815 4	3550 301 815 4	160
08160466	4324100330	RL3511AM24	3511 003 154 0	30	42079484	4324100210	RL3511AM-G	3511 003 051 0	28
08160465	4324100340	RL3511AM26	3511 003 156 0	31	42089956	4630320200	RL8606BA	8606 002 001 0	171
08160472	4324100350	RL3511AM35	3511 003 198 0	31	42095121	4460082300	3550 625 045 0	3550 625 045 0	209
08160473	4324100350	RL3511AM35	3511 003 198 0	31	42095121	4460000000	3550 625 045 0	3550 625 045 0	209
08163008	9730090020	RL3522FB-C	3522 004 004 0	123	42485350	9617220032	RL3526CK-9	3526 001 0119-1	104
0867882	9630060030	RL3520ZA05	3520 501 005 0	135	42485350	9617220032	RL3526EK-9	3526 001 016 0-9	104
08190167	9700519042	RL1608PR-9	1608 045 004 0-9	196	42486086	SV3360	RL1705YA	1705 052 001 0	226
09988413	9710020000	RL3518NC	3527 003 003 0	133	42486484	9730020062	RL3522BH-9	3522 002 001 0-9	124
00101741	9617221510	RL3526AK	3526 002 010 0	93	42487120	4630130042	RL3548AF-9	3548 001 004 0-9	229
1121692	4520021070	RL3520AA	3520 001 001 0	203	42487120	4630130042	RL3548AG-9	3548 001 003 0-9	229
1137760		3509 028 002 1	3509 028 002 1	13	42487276	9347020042	RL3515EA-A-9	3515 003 002 0-9	58
1236222	4342080290	RL3533LA	3533 009 001 0	217	42493396	9349010052	RL3515DA-9	3515 002 001 0-9	58
1261822	LK1314	RL3509AD	3509 004 001 0	1	42493396	9349010052	RL3515KB-9	3515 006 002 0-9	58
1261885	9700511140	RL1608PC	1608 045 001 0	189	42493947	4613150052	RL3514DA-F-9	3514 012 000 0-9	91
1271399	4756040100	RL3520AB-A	3520 002 002 0	203	42493947	4613150052	RL3514DA-G-9	3514 012 001 0-9	91
1278511	9730010100	RL3518AH	3518 001 009 0	140	42530780	4324200000	RL3511AZ	3511 003 036 0	29
1299031	9735000000	RL3516ED	3516 005 002 0	112	42531613	0484210001	RL3754EL03	3754 045 003 0	42
1373808	9617011000	RL3526PA	3526 008 001 0	99	42534245	LK4936	RL3509DJ-A	3509 037 001 0	5
1376275	11159920065	3509 028 005 1	3509 028 005 1	13	42534247	LK4936	RL3509DJ-A	3509 037 001 0	5
1376285	11159920065	3509 028 005 1	3509 028 005 1	13	42535033		RL1705QA05	1705 058 005 0	225
174767	4324100202	RL3511KA	3513 001 001 0	40	42536555	AE4608	RL3515XA09	3515 018 009 0	54
2140302017	4630360000	RL1705CA	1705 003 001 0	224	42536872	LA8125	RL3511XB05	3511 027 002 0	36
222469	4757000042	RL3523DA-9	3523 002 009 9	111	42558601		RL1705QA05	1705 058 005 0	225
222685	4640023300	RL2908FA	2908 006 001 0	165	4460001016	4722500000	RL3754PT02	3754 100 002 0	240
222724		RL3514ME	3514 009 002 0	82	4841086	9617222580	RL3526EK	3526 001 016 0	96
222793	9730020070	RL3522AZ	3522 001 008 0	121	4842678	1186753	RL3519WD	3519 570 003 0	260
228235	9617222520	RL3526CK	3526 001 011 0	95	500002558	4613245200	RL3514DA-R	3514 012 002 0	77
2379560	9522000220	RL3521BD-A	3521 005 005 0	206	500002949	9617230010	RL3526BB	3526 004 002 0	94
2444906	9730010130	RL3518AY	3518 001 014 0	140	500005480	4757100000	RL3523AB-B	3523 001 022 0	107
2472250	9750010000	RL3516QA01	3516 070 001 0	112	5000465223	9347020000	RL3515EA06	3515 003 020 0	50
2494274	4325000200	RL3515ZA	3511 013 001 0	208	5000787875	9700511240	RL1608PE	1608 053 001 0	191
2498634	9617011050	RL3526PD	3526 008 004 0	99	5000792440	9735000060	RL3516EH	3516 005 006 0	113
2514861	5340170090	RL3533NA01	3533 012 001 0	218	500310195	4729000530	RL3754EC02	3754 042 002 0	173
2515034	4341001230	RL3531WA06	3531 013 004 0	62	500310903	K007254	RL3509BH	3509 028 001 0	4
2515210	4522002220	RL3521BC	3521 004 005 0	205	500337674	9254248000	RL3530YZ4	3530 241 004 0	263
2515298	4522002210	RL3521BA-A	3521 004 002 0	205	500337676	9254248010	RL3530YZ5	3530 241 005 0	263
2515829	4750103020	RL3512MA04	3512 010 004 0	64	500340806	4410500120	RL2908NA02	2908 013 002 0	178
2516806	9730024020	RL3522AH	3522 001 001 0	121	500356849	4630360240	RL1705CA07	1705 003 007 0	224
2516829	4341002210	RL3531WA04	3531 013 003 0	62	500382823	DX75BAY	RL3514HE-A	3514 008 010 0	86
2516892	9753034730	RL3512BJ	3512 007 014 0	18	5006041993	4410329212	3550 305 808 0	3550 305 808 0	159
2520243	9343000030	RL3513BB	3536 001 001 0	74	5006041994	4410329222	3550 305 809 0	3550 305 809 0	159
2564591	4630131120	RL3548AG02	3548 001 005 0	223	5006302001	4729000560	RL3754EC01	3754 042 001 0	173
3097151	SEB00967004	3509 028 001 8	3509 028 001 8	13	5010145720	9617232080	RL3526DX06	3526 005 100 0	97
3307710R91	9730110000	RL3518ZA	3518 019 001 0	141	5010206016	9730112000	RL3518ZE-B	3518 019 009 0	142
3506500595	4730170010	RL3518KA01	3518 009 033 0	139	5010206016	59520-Y3B00.2	RL3518ZE-B	3518 019 009 0	142
41002766	DPM95AAX	RL3526NE-A	3526 006 008 0	98	5010207352	4729000590	RL3754EC117	3754 042 117 0	176
41003307EB	4729000630	RL3754EC12	3754 042 012 0	174	5010207451	9730112050	RL3518ZE	3518 019 006 0	142
41003309	4729001100	RL3754EC16	3754 042 016 0	174	5010452512	9700514220	RL1608EA08	1608 042 023 0	186
41016827	4721717000	RLD5-R054	3754 012 051 0	239	5010556022	9700514240	RL1608EA09	1608 042 021 0	186
41025604	9730112030	RL3518ZE-A	3518 019 008 0	142	504088165	4721717060	RLD5-R055	3754 012 048 0	239
41026588	4721732260	RLD5-R058	3754 012 038 0	239	504177095	9700514550	RL1608HA01	1608 090 001 0	188
41027224	4721950180	RL3550FA	3550 210 018 0	157	5801102059	9347140100	RL3515MA	3515 008 001 0	52
41030745	4729001140	RL3754EC19	3754 042 019 0	175					
41031476	4324100760	RL3511AM36	3511 003 199 0	31					

INDEX BY VEHICLE APPLICATIONS

IVECO

OEM No.	Cross Ref.	SORL No.	SORL EU No	Page
5801279152	5801279152	RL1705CA09	1705 003 009 0	224
61259232	9753030850	RL3512BH	3512 007 013 0	20
61598164	9347023800	RL3515EA-D	3515 003 005 0	51
61665462	9735000030	RL3516EE	3516 005 003 0	112
71300013	KN0481500101	RL8606JC	8606 013 001 0	211
8122061	4757004030	RL3523DA	3523 002 009 0	110
8124000	9730020052	RL3522BJ-9	3522 002 010 0-9	124
8124000	9730020052	RL3522BJ-A-9	3522 002 011 0-9	124
8137037	DPM94AAX	RL3526NE	3526 006 005 0	98
8193547	9630060010	RL3520ZC	3520 501 003 0	136
93161152	9617230002	RL3526DX-9	3526 005 001 9	104
93161487	4757140002	RL3523AK-C-9	3523 002 008 9	111
93161490	9617230042	RL3526NA-9	3526 006 001 0-9	104
93161490	9617230042	RL3526NB-9	3526 006 002 0-9	104
93161510	9710020062	RL3518NC-9	3527 003 003 0-9	138
93161820	9700519442	RL1608PJ-9	1608 044 005 0-9	196
93161842	K01920	RL3509BH-9	3509 028 001 9	13
93162116	K01920	RL3509BH-9	3509 028 001 9	13
93162184	9347020012	RL3515EA-B-9	3515 003 003 0-9	58
9432407015	4324070150	RL3511EF02	3511 007 007 8	41
97106463	4729000010	RL3754EC100	3754 042 100 0	175
97164491	LA8062	RL3511NA28	3511 014 046 0	35
97164492	LA8062	RL3511NA28	3511 014 046 0	35
980829	4324101020	RL3511AM	3511 003 025 0	28
980942	9617231020	RL3526DC	3526 005 003 0	96
981819	4324100070	RL3511AM18	3511 003 148 0	30
98417040	4722500030	RL3754PT01	3754 100 001 0	240
98472878	4410500110	RL2908NA01	2908 013 001 0	178
98480157	9347141190	RL3515MB01	3515 008 017 0	52
98490676	47290000500	RL3754EC120	3754 042 120 0	176
IT4358	4640060020	RL2908AA	2908 001 001 0	163
MK130	LA8234	RL3511NA08	3511 014 008 0	33
Spr1	AC577A	RL3518AC01	3518 035 001 0	143
Spr1	AE4605	RL3515XD01	3515 026 001 0	48
Spr1	DPM28A	RL3526NE-B	3526 006 043 0	98
	314014004	RL3531BA-B	3531 002 004 0	60
	4324100750	RL3511AM37	3511 003 200 0	31
	4640070300	RL2908GA19	2908 007 019 0	165
	4720174800	RL8606JA	8606 011 001 0	211
	4721710000	RLD5-R053	3754 012 037 0	239
	4750100130	RL3531NA04	3531 008 004 0	63
	72709	972061931557	972061931557	313
	78964	RL3513EF01	3513 500 001 0	41
	92528	RL3513EF01	3513 500 001 0	41
	9347023900	RL3515EA07	3515 003 021 0	50
	93522	RL3513EF01	3513 500 001 0	41
	9730025000	RL3522BB	3522 002 002 0	121
	AE1103	RL2908YA02	2908 011 002 0	168
	AE1122	RL2908YA01	2908 011 001 0	168
	AE4158	RL3515LF	3515 007 029 0	46
	AE4611	RL3515XA10	3515 018 010 0	54
	AE4641	RL3515XA13	3515 018 013 0	54
	AE4642	RL3515XA14	3515 018 014 0	55
	AE4643	RL3515XA15	3515 018 015 0	55
	AE4644	RL3515XA16	3515 018 016 0	55
	AE4645	RL3515XA17	3515 018 017 0	55
	AE4646	RL3515XA18	3515 018 018 0	55
	AE4648	RL3515XA19	3515 018 019 0	55
	Alternative BY9401	RL3530PP04	3530 390 166 0	262
	DX75BA	RL3514HE	3514 008 004 0	86
	EE4106	RL3513GC	3536 009 004 0	75
	SZ1115	RL2135EA	2135 005 001 0	219
	VG3200	RL1608CA	1608 023 001 0	192
		RL3530WA01	3530 650 001 0	267

JAC

OEM No.	Cross Ref.	SORL No.	SORL EU No	Page	
3506900LE170		RL3526BA13	3526 004 198 0	95	
3519100LE030		RL3530QB8	3530 420 156 0	268	
3519200LE030		RL3530QB9	3530 420 157 0	268	
41710-Y1010.2		RL1608UA-A	1608 080 005 0	193	
59480-Y3B00.2		RL3515MA61	3515 008 061 0	53	
59510-Y3B00.2		RL3518ZB-A	3518 019 003 0	141	
59520-Y3B00.2		RL3518ZE-B	3518 019 009 0	142	
HCV GALLOP	9730110010	RL3518ZB-A	3518 019 003 0	141	
HCV GALLOP	9730112000	RL3518ZE-B	3518 019 009 0	142	
HCV TIPPER	9730112000	RL3518ZE-B	3518 019 009 0	142	
JPB					
	72583	929022511447	929022511447	316	
	72584	930022511447	930022511447	316	
	79659	929022531447	929022531447	316	
	79660	930022531447	930022531447	316	
	79661	986022533537	986022533537	297	
KASSBOHRER					
	622785AM	RL1608XA	1608 049 001 0	181	
	70634	972031061355	972031061355	313	
	70718	970031920917	970031920917	309	
	70719	971031920907	971031920907	310	
	70720	256031920457	256031920457	315	
	70989	972033741557	972033741557	313	
	72014	970031920907	970031920907	309	
	72015	971031920917	971031920917	310	
	72016	986031920057	986031920057	296	
	72252	888033731107	888033731107	318	
	72271	888031021277	888031021277	318	
	72368	970031921407	970031921407	309	
	72369	971031921407	971031921407	310	
	72370	970051921807	970051921807	309	
	72371	971051921807	971051921807	310	
	72372	970032851505	970032851505	309	
	72373	971032851505	971032851505	310	
	72376	256032840905	256032840905	315	
	72416	888031021277	888031021277	318	
	72591	254031951457	254031951457	311	
	72592	255031951457	255031951457	312	
	72758	999033731107	999033731107	322	
	79040	970031951407	970031951407	309	
	79041	971031951407	971031951407	310	
	79236	970031941407	970031941407	309	
	79237	971031941407	971031941407	310	
	79259	971011031207	971011031207	310	
KAMAZ					
	100-3515110	RL3515AF01	3515 021 001 0	57	
	100-3515210	RL3515AG01	3515 022 001 0	57	
	4308,07	4235060020	RL3519AM37	3519 010 290 0	245
		4324101400	RL3511AM11	3511 003 137 0	30
	5297	4757210010	RL3523GC	3523 013 001 0	110
	5460	4757210010	RL3523GC	3523 013 001 0	110
		79128	177051032706	177051032706	295
		79258	970011031207	970011031207	310
		80039	494011031507	494011031507	289
		80040	495011031507	495011031507	#N/A

INDEX BY VEHICLE APPLICATIONS

KAMAZ

OEM No.	Cross Ref.	SORL No.	SORL EU No	Page
	9617230640	RL3526BA14	3526 004 245 0	94
	9617231570	RL3526DC06	3526 005 114 0	96
		RL3526BA10	3526 004 201 0	94
		RL3526DX08	3526 005 101 0	97

KERAX

Kerax	LA8057	RL3511NA26	3511 014 044 0	35
-------	--------	------------	----------------	----

KING LONG

16SPD-04010		RL1608WE03	1608 016 090 0	192
216500130		RL1608DA03	1608 005 028 0	185
325000350		RL3511EQ78	3511 007 078 0	26
3511020-1H-A		RL3511AM-H	3511 003 057 0	32
35GC2-14020		RL3514DX-D96	3514 004 196 0	90
35GC2-15010		RL3515LA	3515 007 001 0	47
35GC2-27010		RL3518BA-C	3518 002 025 0	153
35GC2-33010		RL3533AA16	3533 001 016 0	215
35TAA-14020		RL3514DX-D13	3514 004 313 0	89
35TAA-50030		RL3529TA17	3529 003 017 0	
4721706060		RLD5-R050	3754 012 052 0	238
6125G02-3516010		RL3516CA15	3516 003 015 0	120
6125G02-3518020		RL3518KG-A	3518 009 013 0	139
6125G02-3533010		RL3515LA63	3515 007 063 0	48
642-03505		RL1608DA	1608 005 001 0	185
79353		353031410146	353031410146	295
SK6115-1605900B1		RL1608BM03	1608 003 063 0	184
XM06112E2-3526010		RL3526BA08	3526 004 063 0	94
XM06120F1-3519201		RL3530BV-PL	3530 030 120 0	287
XM06120F1-3519202		RL3530BV-PR	3530 030 121 0	287
		RL3514DX-D11	3514 004 211 0	89
		RL3514DX-D85	3514 004 185 0	89
		RL3514ME10	3514 009 010 0	90
		RL3516AA60	3516 001 060 0	114
		RL3530BV-KL	3530 030 114 0	287
		RL3530BV-KR	3530 030 115 0	287
		RL3533AA	3533 001 001 0	215
		RL3548UA01	3548 030 001 0	228

KOGE

312470	4640060020	RL2908AA	2908 001 001 0	163
314032	4735010040	RL3516BD34	3516 002 034 0	116
318955	4640061000	RL2908AA07	2908 001 007 0	163
322799	9730025390	RL3522BJ-B	3522 002 012 0	122
325209	4729000210	RL3754EC110	3754 042 110 0	176
332607	9730090010	RL3522FB-A	3522 004 003 0	123
335701	4750103030	RL3512MA05	3512 010 005 0	64
336489	9710023000	RL3527DF	3527 004 006 0	132
336490	9630010510	RL3520ZD02	3520 504 002 0	136
337323	4410500110	RL2908NA01	2908 013 001 0	178
337816	4729051110	RL3754EC-B	3754 044 003 0	177
339077	4729000550	RL3754EC07	3754 042 007 0	173
339078	4729000580	RL3754EC11	3754 042 011 0	174
341420	9347050050	RL3515SA01	3515 011 013 0	56
349275	4721950310	RL3518ZC	3518 020 001 0	157
351000	4757145000	RL3523AK-C	3523 002 008 0	110
361688	4630840310	RL8606HB	8606 012 001 0	172
6500287	9710028050	RL3527DE07	3527 004 007 0	132
6501083	9730112010	RL3518ZA01	3518 019 020 0	142
6502113	9730090060	RL3522FA01	3522 004 012 0	122
6502186	4757145000	RL3523AK-C	3523 002 008 0	110
69093	4410500120	RL2908NA02	2908 013 002 0	178

OEM No.	Cross Ref.	SORL No.	SORL EU No	Page
75378	4721271400	RLD5-R061	3754 055 001 0	240
76275	9710021520	RL3518MA	3527 002 001 0	133
76934	4757145000	RL3523AK-C	3523 002 008 0	110
77414	4630320200	RL8606BA	8606 002 001 0	171
77415	4640023300	RL2908FA	2908 006 001 0	165
79310	9710021500	RL3518NB	3527 003 002 0	133
	4410507182	RL2908NA01-8	2908 013 001 8	170

KRONE

500945047	4630320200	RL8606BA	8606 002 001 0	171
505813397	4410500110	RL2908NA01	2908 013 001 0	178
515003124	4630840310	RL8606HB	8606 012 001 0	172
58078841	4410328090	3550 301 809 0	3550 301 809 0	158
58086130	4640061000	RL2908AA07	2908 001 007 0	163
58111590	9710023000	RL3527DF	3527 004 006 0	132
58124230	9630010510	RL3520ZD02	3520 504 002 0	136
58125050	4750103070	RL3512MA09	3512 010 009 0	64
58137741	4729000540	RL3754EC10	3754 042 010 0	174
58104920	4729000210	RL3754EC110	3754 042 110 0	176
58106060	9710021500	RL3518NB	3527 003 002 0	133
5811159	9710023000	RL3527DF	3527 004 006 0	132
5812423	9630010510	RL3520ZD02	3520 504 002 0	136
5812505	4750103070	RL3512MA09	3512 010 009 0	64
5813397	4410500110	RL2908NA01	2908 013 001 0	178
5813398	4729000550	RL3754EC07	3754 042 007 0	173
5815328	4721950410	RL3518ZZ	3518 020 003 0	156
5815453	4721950310	RL3518ZC	3518 020 001 0	157
5815978	4410500120	RL2908NA02	2908 013 002 0	178
5818121	9730112010	RL3518ZA01	3518 019 020 0	142
5870375	9710028050	RL3527DE07	3527 004 007 0	132
9450130	4757145000	RL3523AK-C	3523 002 008 0	110
9450150	4757004030	RL3523DA	3523 002 009 0	110
9450170	9710021520	RL3518MA	3527 002 001 0	133
9450351	4640060020	RL2908AA	2908 001 001 0	163
9450471	4630320200	RL8606BA	8606 002 001 0	171
9451430	4640023300	RL2908FA	2908 006 001 0	165
9454010	4750103080	RL3512MA10	3512 010 010 0	65
9454030	4528020120	RL3521CB	3521 007 001 0	207
9454060	4721271400	RLD5-R061	3754 055 001 0	240
	4065000810 Without 4461080850	RL3518SU01	3518 030 001 0	156

LEYLAND

ACHE908	9347141230	RL3515MB04	3515 008 045 0	53
	280375	RL3518EA2	3518 005 006 0	130
	70510	678031051355	678031051355	301
	70511	970031051355	970031051355	309
	70512	971031051355	971031051355	310
	70624	265031071105	265031071105	328
	70787	972031063595	972031063595	313
	70840	970031061355	970031061355	309
	70841	971031061365	971031061365	310
	70906	678011060505	678011060505	301
	70944	936031061305	936031061305	325
	70945	972031060005	972031060005	313
	70987	254031061355	254031061355	311
	70988	255031061355	255031061355	312
	72019	353051033555	353051033555	295
	72086	972031060025	972031060025	313
	72195	678011010805	678011010805	302
	72403	938051013105	938051013105	325
	72405	678011010805	678011010805	302
	72406	678011010815	678011010815	302

INDEX BY VEHICLE APPLICATIONS

LEYLAND

OEM No.	Cross Ref.	SORL No.	SORL EU No	Page
	72407	678011010795	678011010795	302
	72563	972031050005	972031050005	313
	79427	972031420705	972031420705	313
	Alternative:BS9404	RL3530PE77	3530 390 178 0	262
	Alternative:BS9404	RL3530PP02	3530 390 156 0	262
MAN				
1065220	4325000200	RL3515ZA	3511 013 001 0	208
1065236	4640023300	RL2908FA	2908 006 001 0	165
1065242	4757004030	RL3523DA	3523 002 009 0	110
1065259	4630320200	RL8606BA	8606 002 001 0	171
1065271	9630060010	RL3520ZC	3520 501 003 0	136
11026510099	9617011000	RL3526PA	3526 008 001 0	99
11026530099	9617011050	RL3526PD	3526 008 004 0	99
112232900	9617222580	RL3526EK	3526 001 016 0	96
1170242	4722500000	RL3754PT02	3754 100 002 0	240
1170479	4729001010	RL3754EC115	3754 042 115 0	177
1213753	4729000220	RL3754EC111	3754 042 111 0	176
1232813	4324070600	RL3754AA01	3754 042 005 0	41
1260680	4640061000	RL2908AA07	2908 001 007 0	163
1276700	4324150290	RL3511ER-B	3511 008 082 0	36
1368719	4324100002	RL3511AM-9	3511 003 025 9	44
1368731	4324100202	RL3511KA	3513 001 001 0	40
2017790	4757100000	RL3523AB-B	3523 001 022 0	107
2035185	950364104	RL3527KA	3527 007 001 0	134
236950	4630131160	RL3548AG22	3548 001 022 0	223
4027060	4640060020	RL2908AA	2908 001 001 0	163
4047273	9730110000	RL3518ZA	3518 019 001 0	141
4082200	4721950160	RL3550SM24	3550 210 024 0	157
4086378	4630131120	RL3548AG02	3548 001 005 0	223
51540007058	51540007058	RL3509AE	3509 054 001 0	1
51540007074	51540007074	RL3509AE-A	3509 054 002 0	1
81117016046	SZ1115	RL2135EA	2135 005 001 0	219
81157016003	SZ1114	RL2135DA	2135 004 001 0	219
81259026112	4729001020	RL3754EC116	3754 042 116 0	177
81259026117	4729000020	RL3754EC101	3754 042 101 0	175
81259026118	4729000500	RL3754EC120	3754 042 120 0	176
81259026127	4729000060	RL3754EC103	3754 042 103 0	175
81259026132	4729000320	RL3754EC113	3754 042 113 0	176
81259026144	4729000540	RL3754EC10	3754 042 010 0	174
81259026145	4729000550	RL3754EC07	3754 042 007 0	173
81259026146	4729000530	RL3754EC02	3754 042 002 0	173
81259026147	4729051110	RL3754EC-B	3754 044 003 0	177
81259026154	4729000010	RL3754EC100	3754 042 100 0	175
81259026155	4729000300	RL3754EC112	3754 042 112 0	176
81259026158	4729000570	RL3754EC20	3754 042 020 0	174
81259026168	4729000560	RL3754EC01	3754 042 001 0	173
81259029158	4729000570	RL3754EC20	3754 042 020 0	174
81259370016	4410500110	RL2908NA01	2908 013 001 0	178
81259370023	4410500120	RL2908NA02	2908 013 002 0	178
81259370040	4410501230	RLD5-M041	4101 099 001 0	179
81303756027	VG3200	RL1608CA	1608 023 001 0	192
81307256014	9700511110	RL1608PA03	1608 044 012 0	189
81307256030	I84613	RL1608CA-9	1608 023 002 9	196
81307256053	9700511570	RL1608PA06	1608 044 016 0	188
81307256062	9700511700	RL1608PG	1608 044 003 0	190
81307256065	9700514140	RL1608EH	1608 042 004 0	188
81307256071	9700519192	RL1608PG-9	1608 044 003 0-9	196
81307256079	9700519432	RL1608EA-9	1608 042 001 9	195
81307256084	9700514120	RL1608EA15	1608 042 052 0	186
81307256104	9710514410	RL1608EC14	1608 043 014 0	187
81326200045		RLD5-Z126	1705 518 001 0	200
81326200039		RLD5-Z125	1705 517 001 0	200

OEM No.	Cross Ref.	SORL No.	SORL EU No	Page
81326200049		RLD5-Z124	1705 516 001 0	200
81326200085		RLD5-Z125	1705 517 001 0	200
81326200095		RLD5-Z127	1705 519 001 0	201
81326200045		RLD5-Z126	1705 518 001 0	200
81327346001	5710031040	RL1705BA	1705 012 001 0	225
81327346007	SV3302	RL1705WA	1705 050 001 0	226
81327356011	4220100100	RL3535FA	3535 001 001 0	220
81436096008	9730010100	RL3518AH	3518 001 009 0	140
81436106001	338021001	RL8606EA	8606 005 001 0	171
81436106061	SV1295	RL2908CA	2908 003 001 0	164
81504106575	9254262000	RL3530YZ1	3530 241 001 0	263
81504106576	9254262010	RL3530YZ2	3530 241 002 0	263
81504106581	9254248000	RL3530YZ4	3530 241 004 0	263
81504106582	9254248010	RL3530YZ5	3530 241 005 0	263
81504106642	9254261000	RL3530YY1	3530 630 005 0	263
81504106642	9254261010	RL3530YY2	3530 630 011 0	263
81511016058	4231061060	RL3519AM09	3519 010 192 0	253
81511016172	4231049000	RL3519YA1	3519 810 001 0	248
81511016196	4231051110	RL3519JA19	3519 030 143 0	249
81511016203	4231039000	RL3519NA	3519 360 001 0	246
81511516050	9347023200	RL3515EA-B	3515 003 003 0	51
81512200002	4522000000	RL3521BB01	3521 005 021 0	205
81512206027	4528050040	RL3521CD04	3521 007 004 0	207
81512206049	9522000210	RL3521BB-A	3521 005 002 0	205
81512606002	9343000010	RL3513BB02	3536 001 008 0	74
81521016057	4750100090	RL3531NB	3531 008 002 0	63
81521016076	0481039221000	RL3512NA	3512 014 001 0	19
81521016084	4750103110	RL3512MA13	3512 010 013 0	65
81521016097	9753035030	RL3512BG06	3512 007 063 0	19
81521016118	9753000002	RL3512AB-9	3512 006 102 9	25
81521016150	4750150010	RL3531MA24	3531 007 024 0	63
81521016152	0484210001	RL3754EL03	3754 045 003 0	42
81521016153	4750150040	RL3531MA06	3531 007 006 0	63
81521016191	9753035040	RL3512BG04	3512 007 061 0	19
81521016253	DR3200	RL3512PA06	3512 018 001 0	18
81521016269	4750103000	RL3512MA17	3512 010 017 0	65
81521016270	4750103010	RL3512MA03	3512 010 003 0	64
81521016282	4750103170	RL3512MA22	3512 010 022 0	66
81521016282	4750103180	RL3512MA23	3512 010 023 0	66
81521016282	4750103250	RL3512MA29	3512 010 029 0	67
81521016286	4750104000	RL3512MA	3512 010 001 0	68
81521016294	4750103280	RL3512MA31	3512 010 031 0	67
81521016295	4750103330	RL3512MA33	3512 010 033 0	67
81521019270	4750103010	RL3512MA03	3512 010 003 0	64
81521020016	4324102202	RL3511KC	3513 001 003 0	40
81521026019	LA6200	RL3511CH-A	3511 005 006 0	32
81521026020	4324101110	RL3511AM-B	3511 003 027 0	28
81521026023	4324101020	RL3511AM	3511 003 025 0	28
81521026029	LA6210	RL3511CH	3511 005 005 0	32
81521026038	4324102500	RL3511AM30	3511 003 136 0	31
81521026048	LA6210	RL3511CH	3511 005 005 0	32
81521026097	4324101130	RL3511AM02	3511 003 097 0	28
81521026098	4324101170	RL3511AM03	3511 003 098 0	29
81521026103	4324101160	RL3511AM10	3511 003 130 0	29
81521026118	4324101140	RL3511AM28	3511 003 158 0	31
81521026119	4324101150	RL3511AM04	3511 003 099 0	29
81521026120	4324101140	RL3511AM28	3511 003 158 0	31
81521106009	4341001220	RL3531WA08	3531 013 012 0	62
81521106013	4341002200	RL3531WA09	3531 013 020 0	62
81521106101	4341000470	RL3531WA11	3531 013 036 0	62
81521107011	4341000240	RL3531WA02	3531 013 002 0	62
81521166010	9730010200	RL3518AK	3518 001 013 0	140
81521166040	9730010002	RL3518AK-9	3518 001 013 0-9	154
81521166067	9730060010	RL3518AE01	3518 042 001 0	142

INDEX BY VEHICLE APPLICATIONS

MAN

OEM No.	Cross Ref.	SORL No.	SORL EU No	Page	OEM No.	Cross Ref.	SORL No.	SORL EU No	Page
81521166071	9730112000	RL3518ZE-B	3518 019 009 0	142	88512206003	4522000110	RL3521BB	3521 005 001 0	205
81521166071	59520-Y3B00.2	RL3518ZE-B	3518 019 009 0	142	88521016201	481009017	RL3531GB	3531 010 002 0	61
81521306104	4613150052	RL3514DA-F-9	3514 012 000 0-9	91	88521026007	4324200000	RL3511AZ	3511 003 036 0	29
81521306124	4613150890	RL3514XD05	3514 024 005 0	87	88521206006	4340141000	RL3525HA02	3525 008 002 0	212
81521306129	4613150890	RL3514XD05	3514 024 005 0	87	88521806001	4758003010	RL3523GB	3523 012 001 0	108
81521306130	4613150890	RL3514XD05	3514 024 005 0	87	88523206230	4613072000	RL3514MA	3514 009 000 0	82
81521306148	MB4815	RL3514XA01	3514 019 001 0	87	961076	9730020052	RL3522BJ-9	3522 002 010 0-9	124
81521306148	II36302	RL3514XA01	3514 019 001 0	87	99100360455	9617231020	RL3526DC	3526 005 003 0	96
81521306219	MB4821	RL3514XA03	3514 019 003 0	87	M225975	9617230010	RL3526BB	3526 004 002 0	94
81521306222	MB4820	RL3514XA04	3514 019 004 0	87	N1011010080	9700511760	RL1608PA05	1608 044 014 0	190
81521506012	4730170010	RL3518KA01	3518 009 033 0	139	N1014001718	9700519102	RL1608PK-9	1608 044 006 0-9	196
81521515056	9347022210	RL3515DA05	3515 002 005 0	49	N1014001718	9700519102	RL1608PT-9	1608 047 001 0-9	196
81521516007	9347023000	RL3515EA-A	3515 003 002 0	51	N2255200061	4410329212	3550 305 808 0	3550 305 808 0	159
81521516008	9347000400	RL3515HB	3515 005 002 0	57	N2255200062	4410329632	3550 307 003 0	3550 307 003 0	159
81521516012	9347020012	RL3515EA-B-9	3515 003 003 0-9	58	N2255206003	4410329222	3550 305 809 0	3550 305 809 0	159
81521516013	9347020410	RL3515EA09	3515 003 012 0	50	N2307160011	9700514240	RL1608EA09	1608 042 021 0	186
81521516020	9347022100	RL3515DA	3515 002 001 0	49	N2504016063	4235050000	RL3519JA22	3519 030 267 0	244
81521516037	9347022400	RL3515DA06	3515 002 006 0	49	N2509990158	9630010520	RL3520ZD01	3520 504 001 0	136
81521516046	9347020042	RL3515EA-A-9	3515 003 002 0-9	58	N2509990162	9710023040	RL3527DA	3527 004 001 0	131
81521516046	9730020062	RL3522BH-9	3522 002 001 0-9	124	N2509990164	9710023070	RL3527DB	3527 004 002 0	131
81521516051	I81171	RL3515CA-9	3515 001 001 0-9	58	N2509990166	9710028050	RL3527DE07	3527 004 007 0	132
81521516051	I81171	RL3515LF-9	3515 007 001 9	58	N2509990170	9735000380	RL3516UA01	3516 022 001 0	113
81521516051	I81171	RL3515LF-A-9	3515 007 030 0-9	58	N2521160021	4757111260	RL3523AK-D	3523 002 010 0	109
81521516065	AE4178	RL3515LA05	3515 007 005 0	47	N2521160023	9710021520	RL3518MA	3527 002 001 0	133
81521516073	9347140100	RL3515MA	3515 008 001 0	52	N2521160024	9710023000	RL3527DF	3527 004 006 0	132
81521516073	9347140080	RL3515MB06	3515 008 067 0	53	N2521706021	4630360160	RL1705CA08	1705 003 008 0	224
81521516073	AE4422	RL3515QA05	3515 016 011 0	48	N2524526001	4721950410	RL3518ZZ	3518 020 003 0	156
81521516074	9347023220	RL3515EA01	3515 003 010 0	50	N2955010110	8946011322	3550 430 002 0	3550 430 002 0	160
81521516079	AE4448	RL3515CA05	3515 001 005 0	46	ZG046200002	4630840000	RL3548KA	3548 018 001 0	171
81521516091	9347140090	RL3515MB07	3515 008 086 0	53	ZG046430002	9347050050	RL3515SA01	3515 011 013 0	56
81521516093	AE4613	RL3515XA12	3515 018 012 0	54	ZG046450002	9347141250	RL3515MA35	3515 008 035 0	52
81521616205	4613245200	RL3514DA-R	3514 012 002 0	77	ZG046560002	9730110500	RL3518ZA77	3518 019 077 0	141
81521616268	4757110120	RL3523AK-A	3523 002 006 0	109	ZG046570002	9730112010	RL3518ZA01	3518 019 020 0	142
81521636006	SV3336	RL1705JC01	1705 062 001 0	228	ZG046580002	9735000060	RL3516EH	3516 005 006 0	113
81521706142		RL2135TB01	2135 008 001 0	219		0504002114000	RL2908MC	2908 016 002 0	179
81521706127	0501310059	RL1705QA03	1705 058 003 0	226		314014004	RL3531BA-B	3531 002 004 0	60
81521706156		RL1705SA01	1705 059 001 0	228		4021300120	3509 054 002 8	3509 054 002 8	7
81521856060	4630360240	RL1705CA07	1705 003 007 0	224		4031300645	3509 054 011 8	3509 054 011 8	7
81523016183	9730090060	RL3522FA01	3522 004 012 0	122		4031302816	3509 054 001 8	3509 054 001 8	7
81523016189	9730090060	RL3522FA01	3522 004 012 0	122		4031311016	3509 054 015 1	3509 054 015 1	7
81523016117	9730025010	RL3522BJ	3522 002 010 0	121		4031312002	3509 054 010 8	3509 054 010 8	7
81523155160	9617230190	RL3526NA	3526 006 001 0	98		4231054060	RL3519JA37	3519 030 436 0	249
81523156068	9617210070	RL3526VA	3526 020 001 0	99		4324101400	RL3511AM11	3511 003 137 0	30
81523156113	9617231000	RL3526DX07	3526 005 051 0	97		4410329632	3550 307 003 0	3550 307 003 0	159
81523156129	9617230002	RL3526DX-9	3526 005 001 9	104		4421300008	3509 054 003 8	3509 054 003 8	7
81523156165	9617210040	RL3526VB	3526 020 002 0	99		4471310215	3509 054 001 1	3509 054 001 1	7
81523206030	MB4434	RL3514CA	3514 003 000 0	83		4640070300	RL2908GA19	2908 007 019 0	165
81749206017	4720174800	RL8606JA	8606 011 001 0	211		4750103100	RL3512MA12	3512 010 012 0	65
81970106011		RLD5-Z082	1705 501 001 0	198		4750103150	RL3512MA20	3512 010 020 0	66
81991643679	9730010130	RL3518AY	3518 001 014 0	140		4750103160	RL3512MA21	3512 010 021 0	66
81998062077	9522010010	RL3521EA02	3521 014 002 0	206		4750103190	RL3512MA24	3512 010 024 0	66
82521016019	9753030012	RL3512BG-9	3512 007 007 0-9	25		4750103200	RL3512MA25	3512 010 025 0	66
82521016019	9753030012	RL3512BJ-9	3512 007 014 0-9	25		4750103210	RL3512MA26	3512 010 026 0	66
82523016000	9730020000	RL3522AZ13	3522 001 013 0	121		4750103220	RL3512MA27	3512 010 027 0	67
82523016015	9730093000	RL3522FA	3522 004 001 0	122		4750103230	RL3512MA28	3512 010 028 0	67
82523016018	9730090012	RL3522FA-9	3522 004 001 0-9	124		4750103260	RL3512MA30	3512 010 030 0	67
82523106008	9630010130	RL3520ZA	3520 501 001 0	135		4750103290	RL3512MA32	3512 010 032 0	67
84521016011	4750100130	RL3531NA04	3531 008 004 0	63		4750103340	RL3512MA37	3512 010 037 0	68
84521016039	4750103120	RL3512MA14	3512 010 014 0	65		585LL	RLD5-Z082	1705 501 001 0	198
84521016040	4750103070	RL3512MA09	3512 010 009 0	64		622785AM	RL1608XA	1608 049 001 0	181
84521206013	4340140010	RL3525HA01	3525 008 001 0	212		70753	220022633397	220022633397	304
85300019898	9700519042	RL1608PA-9	1608 044 001 0-9	196		70754	219022633397	219022633397	304
85500014354	4613150080	RL3514DS	3514 004 025 0	78		70771	985022633467	985022633467	306
85500014558	9617231110	RL3526DX03	3526 005 018 0	97		70772	984022633467	984022633467	306

INDEX BY VEHICLE APPLICATIONS

MAN

OEM No.	Cross Ref.	SORL No.	SORL EU No	Page	OEM No.	Cross Ref.	SORL No.	SORL EU No	Page	
	70867	212022630757	212022630757	314		79223	992012631007	992012631007	319	
	72012	997012631017	997012631017	307		79224	991012631007	991012631007	319	
	72013	998012631017	998012631017	307		79225	987142630757	987142630757	320	
	72208	256012631107	256012631107	315		79226	988142630757	988142630757	320	
	72303	231062631447	231062631447	303		79227	256012631187	256012631187	315	
	72304	232062631447	232062631447	304		79228	219012630537	219012630537	304	
	72308	212022630757	212022630757	314		79229	220012630537	220012630537	304	
	72320	220022633397	220022633397	304		79514	231062631447	231062631447	303	
	72321	219022633397	219022633397	304		79515	232062631447	232062631447	304	
	72322	212022630757	212022630757	314		79606	987012630947	987012630947	320	
	72348	353012630307	353012630307	295		79607	988012630947	988012630947	320	
	72438	678012631057	678012631057	302		79608	994012631057	994012631057	306	
	72455	219012631037	219012631037	304		79695	256012631357	256012631357	315	
	72456	220012631037	220012631037	304		80086	488012630217	488012630217	290	
	72508	992012631007	992012631007	319		80183	488012630217	488012630217	290	
	72509	991012631007	991012631007	319		8997598154	3550 301 510 4	3550 301 510 4	159	
	72512	987142630757	987142630757	320		92528	RL3513EF01	3513 500 001 0	41	
	72513	988142630757	988142630757	320		9347023900	RL3515EA07	3515 003 021 0	50	
	72515	353012630387	353012630387	295		9347140130	RL3515MB	3515 008 002 0	52	
	72561	984022633467	984022633467	306		93522	RL3513EF01	3513 500 001 0	41	
	72562	985022633467	985022633467	306		9700511000	RL1608PC-A	1608 044 033 0	189	
	72578	256012631187	256012631187	315		9700514130	RL1608EF	1608 042 003 0	187	
	72613	353012630307	353012630307	295		9753031690	RL3512BG08	3512 007 065 0	20	
	72731	219012630537	219012630537	304		AE4162	RL3515CA	3515 001 001 0	46	
	72732	220012630537	220012630537	304		HB1142	RL3526QL02	3526 030 002 0	100	
	72809	219012631037	219012631037	304			RL1608EA03	1608 042 010 0	186	
	72810	220012631037	220012631037	304			RL1608EA05	1608 042 012 0	186	
	72811	219012630537	219012630537	304			RL3515XA03	3515 018 003 0	54	
	72812	220012630537	220012630537	304						
	72865	256012631357	256012631357	315						
	72965	997012631017	997012631017	307						
	72966	998012631017	998012631017	307	MCW					
	72967	256012631107	256012631107	315		70893	254031050755	254031050755	311	
	72968	231062631447	231062631447	303		70894	255031050755	255031050755	312	
	72969	232062631447	232062631447	304		70930	231031050755	231031050755	303	
	72971	219022633397	219022633397	304		70931	232031050755	232031050755	303	
	72972	212022630757	212022630757	314		72140	970031050755	970031050755	309	
	72975	353012630307	353012630307	295		72141	971031050755	971031050755	310	
	72980	678012631057	678012631057	302		72144	972021053395	972021053395	314	
	72981	219012631037	219012631037	304		72147	254031050505	254031050505	311	
	72982	220012631037	220012631037	304		72148	255031050505	255031050505	312	
	72985	992012631007	992012631007	319		72189	678031040765	678031040765	301	
	72986	991012631007	991012631007	319		72190	678031040735	678031040735	301	
	72987	987142630757	987142630757	320		72452	984031050405	984031050405	306	
	72988	988142630757	988142630757	320		82361	678031050655	678031050655	302	
	72989	256012631187	256012631187	315						
	72990	219012630537	219012630537	304	MERCEDES					
	72991	220012630537	220012630537	304		0001301117	4110426202	3509 001 003 8	3509 001 003 8	6
	78964	RL3513EF01	3513 500 001 0	41		0001305019		RL3509DH-C-9	3509 033 001 9	11
	79202	353012630387	353012630387	295		0001305317	9115016242	3509 003 004 9	3509 003 004 9	10
	79203	984022633467	984022633467	306		0001310809	4111516522	3509 056 002 9	3509 056 002 9	9
	79204	985022633467	985022633467	306		0001310909	4111516522	3509 056 002 9	3509 056 002 9	9
	79205	997012631017	997012631017	307		0001311132	4110426604	3509 001 006 1	3509 001 006 1	6
	79206	998012631017	998012631017	307		0001312121		3509 056 003 1	3509 056 003 1	9
	79207	256012631107	256012631107	315		0001312417	9111457372	3509 003 005 8	3509 003 005 8	9
	79208	231062631447	231062631447	303		0001312419	9111457372	3509 003 005 8	3509 003 005 8	9
	79209	232062631447	232062631447	304		0001312517	9111457372	3509 003 005 8	3509 003 005 8	9
	79210	220022633397	220022633397	304		0001312932	4111476034	3509 003 008 1	3509 003 008 1	9
	79211	219022633397	219022633397	304		0001313716	4110426904	3509 001 005 1	3509 001 005 1	6
	79212	212022630757	212022630757	314		0001317616		3509 033 004 1	3509 033 004 1	11
	79215	353012630307	353012630307	295		0001319311		3509 005 005 9	3509 005 005 9	8
	79218	678012631057	678012631057	302		0002540147	9700511900	RL1608PS01	1608 048 002 0	191
	79219	219012631037	219012631037	304		0002540447	9710514410	RL1608EC14	1608 043 014 0	187
	79220	220012631037	220012631037	304		0002600863	4220100100	RL3535FA	3535 001 001 0	220

INDEX BY VEHICLE APPLICATIONS

MERCEDES

OEM No.	Cross Ref.	SORL No.	SORL EU No	Page	OEM No.	Cross Ref.	SORL No.	SORL EU No	Page
0002602803	4220100120	RL3535FA02	3535 002 002 0	220	0004309681	9617222320	RL3526RB	3526 010 002 0	96
0002604368	4630630002	RL1705RA-9	1705 007 001 0-9	229	0004313615	4324200020	RL3511AZ-A	3511 003 037 0	29
0002604368	4630630002	RL1705RB-9	1705 007 002 0-9	229	0004316715	4324200000	RL3511AZ	3511 003 036 0	29
0002604663		RL3535FA03	3535 006 001 0	221	0004317115	4324210020	RL3511AM05	3511 003 100 0	29
0002604757	SV3302	RL1705WA	1705 050 001 0	226	0004318213	AC596A	RL3522YC01	3522 010 001 0	123
0002606263		RL1704EA01	1704 003 001 0	227	0004318815	4324100410	RL3511AM-E	3511 003 049 0	28
0002607063	4220100140	RL3535GA	3535 002 001 0	221	0004319005	4612951000	RL3514MH	3514 009 007 0	82
0002900247	9700519042	RL1608PA-9	1608 044 001 0-9	196	0004319405	4614911020	RL3514ME11	3514 009 011 0	82
0002900247	9700519042	RL1608PC-9	1608 045 001 9	196	0004320607	9343000010	RL3513BB02	3536 001 008 0	74
0002900247	9700519042	RL1608PQ-9	1608 045 0030-9	196	0004340501	4630131160	RL3548AG22	3548 001 022 0	223
0002900247	9700519042	RL1608PR-9	1608 045 004 0-9	196	0004343801	4630132000	RL3548NA	3548 014 001 0	223
0002900347	9700519162	RL1608LB-9	1608 041 110 9	194	0005401639	4460082300	3550 625 045 0	3550 625 045 0	209
0002900347	9700519162	RL1608LB-A-9	1608 041 002 9	194	0005401639	4460000000	3550 625 045 0	3550 625 045 0	209
0002900647	9700519102	RL1608PK-9	1608 044 006 0-9	196	0005424018	4410500110	RL2908NA01	2908 013 001 0	178
0002900647	9700519102	RL1608PT-9	1608 047 001 0-9	196	0005424018	4410500120	RL2908NA02	2908 013 002 0	178
0002950018	9700511370	RL1608PK	1608 044 006 0	190	0005481370	8942600492	K2432	3511 012 005 0	42
0002950818	9700511510	RL1608PS	1608 048 001 0	188	0005865742	9730010002	RL3518AH-9	3518 001 009 0-9	154
0002950918	9700511590	RL1608LB-A	1608 041 002 0	185	0005865742	9730010002	RL3518AK-9	3518 001 013 0-9	154
0002951318	9700511640	RL1608PA01	1608 044 009 0	188	0006201207	9735000030	RL3516EE	3516 005 003 0	112
0002951518	9700511580	RL1608LB	1608 041 001 0	185	0007600278	4720174810	RL8606JB	8606 011 002 0	211
0002952318	9700511740	RL1608PA02	1608 044 010 0	190	0007600378	4720174800	RL8606JA	8606 011 001 0	211
0002953618	9700511840	RL1608PA07	1608 044 017 0	191	0009974036	4721271400	RLD5-R061	3754 055 001 0	240
0002953718	9700514330	RL1608EC09	1608 043 009 0	187	0009982790		3509 033 002 1	3509 033 002 1	11
0002955006	13635002	RLWM100-1605010	1604 192 015 0	198	0011302615	4123529222	3509 033 002 9	3509 033 002 9	11
0003276225	4729000010	RL3754EC100	3754 042 100 0	175	0011301215	4123529222	3509 033 002 9	3509 033 002 9	11
0003276325	4729000210	RL3754EC110	3754 042 110 0	176	0011305219	4123529222	3509 033 002 9	3509 033 002 9	11
0003276525	4729000500	RL3754EC120	3754 042 120 0	176	0012600057	SV3360	RL1705YA	1705 052 001 0	226
0003276625	4729000580	RL3754EC11	3754 042 011 0	174	0012600657	4630630020	RL1705RB	1705 007 002 0	226
0003276725	4729000530	RL3754EC02	3754 042 002 0	173	0012602757	SV3302	RL1705WA	1705 050 001 0	226
0003276725	4729000600	RL3754EC03	3754 042 003 0	173	0012603157	4630630030	RL1705RA	1705 007 001 0	226
0003276825	4729051110	RL3754EC-B	3754 044 003 0	177	0012606357	4630690030	RL1705GA	1705 016 001 0	228
0003277425	4729000560	RL3754EC01	3754 042 001 0	173	0012606757	SV3367	RL1705ZA	1705 053 001 0	226
0003279725	4728800640	RL3754EC301	3754 046 001 0	177	0012608457	SW3371	RL1705XA	1705 051 001 0	226
0003530255	4214120000	RL2135FC	2135 006 003 0	220	0012953107	9700511310	RL1608KA	1608 039 001 0	185
0004207624	4231051110	RL3519JA19	3519 030 143 0	249	0012955607	9700511280	RL1608PE02	1608 053 003 0	191
0004208924	4231061060	RL3519AM09	3519 010 192 0	253	0014206824	4231069000	RL3519ZA1	3519 820 001 0	253
0004292044	4341002200	RL3531WA09	3531 013 020 0	62	0014290430	4528020120	RL3521CB	3521 007 001 0	207
0004293044	9730010200	RL3518AK	3518 001 013 0	140	0014291744	4750103090	RL3512MA11	3512 010 011 0	65
0004293995	4324102202	RL3511KC	3513 001 003 0	40	0014292144	4730170080	RL3518KA-A	3518 009 032 0	139
0004294544	481009017	RL3531GB	3531 010 002 0	61	0014299044	4750103020	RL3512MA04	3512 010 004 0	64
0004295544	4341000240	RL3531WA02	3531 013 002 0	62	0014300281	9617222520	RL3526CK	3526 001 011 0	95
0004296444	4341001220	RL3531WA08	3531 013 012 0	62	0014300460	4613150052	RL3514DA-F-9	3514 012 000 0-9	91
0004297144	4341001230	RL3531WA06	3531 013 004 0	62	0014300460	4613150052	RL3514DA-G-9	3514 012 001 0-9	91
0004297544	4341001250	RL3531WA01	3531 013 001 0	61	0014300660	4613190022	RL3514EB-9	3514 013 002 9	91
0004299830	4528050040	RL3521CD04	3521 007 004 0	207	0014300660	4613190022	RL3514EB-A-9	3514 013 003 9	91
0004301415	9324000002	RL3511DH-9	3511 006 009 0-9	44	0014300660	4613190022	RL3514EB-B-9	3514 013 006 9	91
0004300126	4214110200	RL2135CA	2135 003 001 0	219	0014304960	9753030012	RL3512BG-9	3512 007 007 0-9	25
0004300509	4630131140	RL3548AG	3548 001 003 0	223	0014304960	9753030012	RL3512BJ-9	3512 007 014 0-9	25
0004301107	9753000002	RL3512AB-9	3512 006 102 9	25	0014304960	9753030012	RL3512BK-9	3512 007 015 0-9	25
0004301315	9324000240	RL3511DG02	3511 006 030 0	36	0014307460	4630130052	RL3548MA-9	3548 015 001 0-9	229
0004301515	9324000030	RL3511DH-A	3511 006 010 0	36	0014310006	9753001100	RL3512AB	3512 006 002 0	17
0004301826	SZ1114	RL2135DA	2135 004 001 0	219	0014310006	9753034640	RL3512BG	3512 007 007 0	18
0004302370	4324070600	RL3754AA01	3754 042 005 0	41	0014310006	9753034730	RL3512BJ	3512 007 014 0	18
0004302670	4324070150	RL3511EF02	3511 007 007 8	41	0014315706	4750150010	RL3531MA24	3531 007 024 0	63
0004302706	4613159002	RL3514DS-9	3514 004 0259-1	91	0014312206	9753030800	RL3512BG02	3512 007 059 0	19
0004302706	4613159002	RL3514DS-D-9	3514 004 047 9	91	0014312206	9753034470	RL3512BG29	3512 007 089 0	20
0004302706	4613159002	RL3514DS-F-9	3514 004 052 9	91	0014312605	4712000080	RL3522YB03	3522 009 003 0	123
0004303706	9730090002	RL3522FB-9	3522 004 002 0-9	124	0014313006	9347023000	RL3515EA-A	3515 003 002 0	51
0004303706	9730090002	RL3522FB-A-9	3522 004 003 9	124	0014313006	9347023400	RL3515EA-C	3515 003 004 0	51
0004303706	9730090002	RL3522FB-C-9	3522 004 004 9	124	0014313212	4757100000	RL3523AB-B	3523 001 022 0	107
0004306906	4613159142	RL3514EC-9	3514 013 004 0-9	91	0014313312	4757100200	RL3523AB-D	3523 001 024 0	108
0004308106	4613159202	RL3514EA-9	3514 013 000 9	91	0014313505	4700120000	RL3514MF	3514 009 003 0	83
0004309581	9617222120	RL3526RA	3526 010 001 0	96					

INDEX BY VEHICLE APPLICATIONS

MERCEDES

OEM No.	Cross Ref.	SORL No.	SORL EU No	Page	OEM No.	Cross Ref.	SORL No.	SORL EU No	Page
0014313506	9347022100	RL3515DA	3515 002 001 0	49	0034311705	4613192710	RL3514EB	3514 013 002 0	81
0014313506	9347022210	RL3515DA05	3515 002 005 0	49	0034314806	9753030710	RL3512BG01	3512 007 058 0	19
0014313805	4613072000	RL3514MA	3514 009 000 0	82	0034315106	4750103240	RL3512MA16	3512 010 016 0	65
0014314606	9347000400	RL3515HB	3515 005 002 0	57	0034315406	9347050050	RL3515SA01	3515 011 013 0	56
0014314905	9730024000	RL3522AB01	3522 001 014 0	121	0034315406	9347050010	RL3515SA06	3515 011 021 0	56
0014315800	AE4178	RL3515LA05	3515 007 005 0	47	0034315506	9347050020	RL3515SA	3515 011 001 0	55
0014316106	9753035030	RL3512BG06	3512 007 063 0	19	0034316106	AE4510	RL3515AH02	3515 023 002 0	56
0014316306	4750150040	RL3531MA06	3531 007 006 0	63	0034316305	4613192500	RL3514EB-A	3514 013 003 0	81
0014316705	9730025200	RL3522BH	3522 002 001 0	121	0034316906	9347141250	RL3515MA35	3515 008 035 0	52
0014317815	9325000060	RL3511DG34	3511 006 034 0	27	0034317305	4613150530	RL3514DS-F	3514 004 048 0	78
0014318112	4767100360	RL3523AB-C	3523 001 023 0	107	0034319706	AE4800	RL3515AE01	3515 020 001 0	57
0014318212	4767100360	RL3523AB-C	3523 001 023 0	107	0035860943	9349010052	RL3515DA-9	3515 002 001 0-9	58
0014318305	4613150080	RL3514DS	3514 004 025 0	78	0035860943	9349010052	RL3515KB-9	3515 006 002 0-9	58
0014318905	MB4629	RL3514HA	3514 008 000 0	85	0039972226	4630360050	RL1705CB	1705 003 002 0	224
0014319905	MB4629	RL3514HA	3514 008 000 0	85	0039977036	4630132100	RL3548PA	3548 013 001 0	224
0014318605	9730025010	RL3522BJ	3522 002 010 0	121	0004296344	4341001240	RL3531WA07	3531 013 005 0	62
0014318705	9730025390	RL3522BJ-B	3522 002 012 0	122	0004301315	9324000020	RL3511DG42	3511 006 042 0	36
0014319305	4613074390	RL3514MD	3514 009 005 0	82	0044290444	4750100090	RL3531NB	3531 008 002 0	63
0014319412	4757110240	RL3523AK-B	3523 002 007 0	109	0044290644	9730060010	RL3518AE01	3518 042 001 0	142
0015865343	9347020012	RL3515EA-B-9	3515 003 003 0-9	58	0044292244	4342080300	RL3533LB22	3533 009 022 0	218
0019979136	4630370010	RL1705UA	1705 009 001 0	224	0044292544	356013011	RL3516TA	3516 015 001 0	118
0020317106	9753034720	RL3512BG05	3512 007 062 0	19	0044293844	9730110010	RL3518ZB-A	3518 019 003 0	141
0022606157		RL1705ZB01	1705 078 001 0	227	0044293844	59510-Y3B00.2	RL3518ZB-A	3518 019 003 0	141
0024206518	4231059000	RL3519JA18	3519 030 142 0	249	0044296244	9730110040	RL3518ZH	3518 019 010 0	141
0024209224	9347022400	RL3515DA06	3515 002 006 0	49	0044296544	4721950160	RL3550SM24	3550 210 024 0	157
0024291744	4750100130	RL3531NA04	3531 008 004 0	63	0044297644	9730112000	RL3518ZE-B	3518 019 009 0	142
0024296844		RL3531WA04	3531 013 003 0	62	0044297644	59520-Y3B00.2	RL3518ZE-B	3518 019 009 0	142
0024299644		RL3525CA03	3525 012 001 0	212	0044298144	4341000470	RL3531WA11	3531 013 036 0	62
0024302481	9617222750	RL3526CK04	3526 001 110 0	95	0044299644	4750103180	RL3512MA23	3512 010 023 0	66
0024307481	9617230050	RL3526NA-B	3526 006 009 0	98	0044299644	4750103310	RL3512MA35	3512 010 035 0	68
0024307581	9617231040	RL3526NB	3526 006 002 0	98	0044310205	4613192620	RL3514EB01	3514 013 023 0	81
0024310605	4613190080	RL3514DD	3514 004 003 0	77	0044314605	4613152640	RL3514EC	3514 013 004 0	81
0024311505	4613170240	RL3514DG-A	3514 004 008 0	78	0044314905	4613192740	RL3514EA03	3514 013 017 0	81
0024311506	9753034740	RL3512BK	3512 007 015 0	18	0044316205	4613192740	RL3514EA03	3514 013 017 0	81
0024311606	9753035040	RL3512BG04	3512 007 061 0	19	0049978936	4721717000	RLD5-R054	3754 012 051 0	239
0024313006	9753000140	RL3512AC	3512 006 003 0	17	0049979336	4721706160	RLD5-R051	3754 012 045 0	239
0024314205	9730025220	RL3522BH02	3522 002 021 0	122	0054290344	4750103250	RL3512MA29	3512 010 029 0	67
0024315405	4613150040	RL3514DS-D	3514 004 047 0	78	0054290344	4750103320	RL3512MA36	3512 010 036 0	68
0024316606	9753030850	RL3512BH	3512 007 013 0	20	0054291044	9730112050	RL3518ZE	3518 019 006 0	142
0024317005	4613192600	RL3514EB-B	3514 013 006 0	81	0054293244	4750103170	RL3512MA22	3512 010 022 0	66
0024317306	9347022600	RL3515WA01	3515 017 001 0	49	0054293244	4750103300	RL3512MA34	3512 010 034 0	67
0024317606	AE4404	RL3515QA02	3515 016 007 0	48	0054297444	4750103350	RL3512MA38	3512 010 038 0	68
0024319406	9347023200	RL3515EA-B	3515 003 003 0	51	0054298444	4750103380	RL3512MA39	3512 010 039 0	68
0025423118	4410328080	3550 301 808 0	3550 301 808 0	158	0054298544	4750103390	RL3512MA40	3512 010 040 0	68
0025861043	9347000002	RL3515HB-9	3515 005 002 0-9	58	0059971236	4720706390	RLD5-R048	3754 012 049 0	238
0025865942	9347020042	RL3515EA-A-9	3515 003 002 0-9	58	0064205224	4231047100	RL3519HA11	3519 210 107 0	243
0025865942	9730020062	RL3522BH-9	3522 002 001 0-9	124	0064206818	9253212020	RL3530CA17	3530 060 093 0	271
0034290744	4340141000	RL3525HA02	3525 008 002 0	212	0064206818	9253212020	RL3530CA93	3530 060 907 0	273
003429134	9730010062	RL3518AZ-9	3518 001 015 0-9	154	0074201224	4235050000	RL3519JA22	3519 030 267 0	244
0034291344	9730012110	RL3518AZ	3518 001 015 0	140	0074201424	T20	RL3519AM11	3519 010 194 0	245
0034294444	4750103110	RL3512MA13	3512 010 013 0	65	0074202918	9253224230	RL3530SB12	3530 480 222 0	276
0034297844	4730170010	RL3518KA01	3518 009 033 0	139	0084206018	Alternative 9253211600	RL3530CA-A58	3530 060 458 0	272
0034303281	9617220032	RL3526CK-9	3526 001 0119-1	104	0124200018	9254241000	RL3530RA16	3530 450 040 0	268
0034303281	9617220032	RL3526EK-9	3526 001 016 0-9	104	0124209118	9254610000	RL3530CA35	3530 060 162 0	267
0034303281	9617220032	RL3526FK-9	3526 001 017 9	104	0154203318	9254840100	RL3530RY10	3530 452 011 0	265
0034303281	9617220032	RL3526RA-9	3526 010 001 9	104	0154203418	9254840110	RL3530RY11	3530 452 012 0	265
0034303281	9617220032	RL3526RB-9	3526 010 0029-1	104	0154205718	9254680120	RL3530YX2	3530 690 002 0	264
0034305281	9617230002	RL3526DX-9	3526 005 001 9	104	0154205718	9254880140	RL3530YX8	3530 690 012 0	264
0034305281	9617230002	RL3526DY-9	3526 005 002 9	104	0154205818	9254680130	RL3530YX3	3530 690 003 0	264
0034305381	9617210082	RL3526VA-9	3526 020 001 0-9	104	0154205818	9254880150	RL3530YX9	3530 690 013 0	264
0034305981	9617234210	RL3526NA38	3526 006 038 0	98	0154205918	9254680200	RL3530YX4	3530 690 004 0	264
0034307381	9617231250	RL3526XC01	3526 042 001 0	100	0154206018	9254680210	RL3530YX5	3530 690 005 0	264
0034311305	9730090010	RL3522FB-A	3522 004 003 0	123	0154206118	9254680100	RL3530YX1	3530 690 001 0	264
0034311505	4613152580	RL3514EA	3514 013 000 0	80	0154207518	Alternative 9254800100	RL3530PE73	3530 390 177 0	266

INDEX BY VEHICLE APPLICATIONS

MERCEDES

OEM No.	Cross Ref.	SORL No.	SORL EU No	Page	OEM No.	Cross Ref.	SORL No.	SORL EU No	Page
0011315201	4110345010	RL3509AA	3509 001 001 0	1	A0004318815	4324100410	RL3511AM-E	3511 003 049 0	28
0014317915	9325000070	RL3511DG32	3511 006 032 0	27	A0014310006	DR3500	RL3512CB	3512 008 001 0	20
0015429218	4410435011	RL3511ZB01	3511 017 001 0	27	A0014310106	AE4170	RL3515LF-B	3515 007 031 0	46
0024310615	9325000130	RL3511DG33	3511 006 033 0	27	A0014313312008	4757100080	RL3523AB-A	3523 001 021 0	107
0024310715	9325000140	RL3511DG31	3511 006 031 0	27	A0014315606	0481009021000	RL3531GE	3531 010 005 0	61
0154208118	9254840200	RL3530RY2	3530 452 002 0	265	A0014315706	0481009022000	RL3531GD	3531 010 004 0	61
0154206318	9254840200	RL3530RY2	3530 452 002 0	265	A0021311501	II15140	RL3509CD	3509 005 003 0	3
0154209018	9254610010	RL3530CA36	3530 060 172 0	267	A0021313701	II15140	RL3509CD	3509 005 003 0	3
0154209218	9254810130	RL3530CA54	3530 060 428 0	267	A0024290444	4340140010	RL3525HA01	3525 008 001 0	212
0154209318	9254810120	RL3530CA53	3530 060 427 0	267	A0024318306	DR3500	RL3512CB	3512 008 001 0	20
0174209518	9254860100	RL3530SY1	3530 240 001 0	263	A0034315506	9347050020	RL3515SA	3515 011 001 0	55
0174209618	9254860110	RL3530SY2	3530 240 002 0	263	A0044298044	0481026303000	RL3518AD01	3518 036 001 0	142
0184204617	9254680220	RL3530YX6	3530 690 006 0	264	A0044299644	4750103310	RL3512MA35	3512 010 035 0	68
0184204718	9254680230	RL3530YX7	3530 690 007 0	264	A0054290344	4750103320	RL3512MA36	3512 010 036 0	68
0184205218	9254645010	RL3530RY8	3530 452 008 0	265	A0054293244	4750103300	RL3512MA34	3512 010 034 0	67
0184205318	9254645000	RL3530RY7	3530 452 007 0	265	A0054297444	4750103350	RL3512MA38	3512 010 038 0	68
0184205518	Alternative 9254601000	RL3530PF22	3530 390 022 0	265	A0054298444	4750103380	RL3512MA39	3512 010 039 0	68
0184205618	Alternative 9254601010	RL3530PE02	3530 390 023 0	265	A0054298544	4750103390	RL3512MA40	3512 010 040 0	68
0194205918	9254840200	RL3530RY2	3530 452 002 0	265	A0154206118	9254680100	RL3530YX1	3530 690 001 0	264
0204205918	9254840210	RL3530RY1	3530 452 001 0	265	A3761310101	II36928R	RL3509CC	3509 005 002 0	3
0204206018	9254840200	RL3530RY2	3530 452 002 0	265	A3761317401	II36928R	RL3509CC	3509 005 002 0	3
0204206518	9254840220	RL3530RY3	3530 452 003 0	265	A4271300515	4751300115R	RL3509AZ-E	3509 055 001 0	2
0204206618	9254840230	RL3530RY4	3530 452 004 0	265	A4751300115	4751300115R	RL3509AZ-E	3509 055 001 0	2
0204207518	9254880100	RL3530YX10	3530 690 015 0	264	A9061300615	8845034370	RL3509BX	3509 056 001 0	2
0214206518	9254840220	RL3530RY3	3530 452 003 0	265	Actros	9254812000	RL3509AZ-E-9	3509 055 001 9	8
0214206618	9254840230	RL3530RY4	3530 452 004 0	265	Actros	9254812010	RL3530CA56	3530 060 434 0	267
0214207518	9254840260	RL3530RY5	3530 452 005 0	265	Actros	Alternative 9254610100	RL3530CA57	3530 060 435 0	267
0214207618	9254840270	RL3530RY6	3530 452 006 0	265	Axor	AE4615	RL3530CA92	3530 060 178 0	266
0501316050	BS9520	RL3530CB07	3530 061 027 0	262	Axor	K010108A	RL3515XA07	3515 018 007 0	54
3454317105	4613150400	RL3514DX-D22	3514 004 222 0	80	Axor	K010108B1	RL3548BA01	3548 033 001 0	233
3464201738	4335065140	6085612617	6085612617	331	Axor	K010108B1	RL3548BA02	3548 033 002 0	233
3464201838	4335065150	6075612617	6075612617	331	B919025111601	4528030050	RL3521CA03	3521 006 003 0	207
3644307181	9617222840	RL3526CK03	3526 001 104 0	95	B950826401201	4756040100	RL3520AB-A	3520 002 002 0	203
3842957018	9700511790	RL1608PE01	1608 053 002 0	191	Daimler	AE4527	RL3515AH09	3515 023 009 0	56
3844307309	9617221820	RL3526AK01	3526 002 150 0	93	Daimler	AE4615	RL3515XA07	3515 018 007 0	54
3864297044	9730110070	RL3518ZA05	3518 019 044 0	141	Daimler 1217	LA6734	RL3511NB02	3511 014 002 0	33
3884307709	9617223150	RL3526CK06	3526 001 114 0	95	Daimler 1313	AC577A	RL3518AC01	3518 035 001 0	143
4421300020		RL3509AE-9	3509 054 001 9	7	Daimler 1424	LA6734	RL3511NB02	3511 014 002 0	33
4421300720		RL3509AE-9	3509 054 001 9	7	Daimler 2222	Alternative BS9397	RL3530QB6	3530 420 233 0	262
4421300220		RL3509AE-9	3509 054 001 9	7	Daimler 4047636	4613190072	RL3514DD-9	3514 004 003 0-9	91
4571300515	9111530010	RL3509DH-B	3509 032 001 0	3	Daimler Axor	LA9010	RL3511XB03	3511 020 003 0	36
4571301815	9115530020	RL3509BC	3509 003 001 0	3	Daimler Chrysler AG	9617222640	RL3526CK116	3526 001 116 0	96
4571304415	4123520260	RL3509DH-C	3509 033 001 0	3	Daimler SK	LA6734	RL3511NB02	3511 014 002 0	33
4571304915	9125101040	RL3509DH-E	3509 035 001 0	4		Similar with 03.130.00.01	RL3530RB10A	3530 451 010 0	277
533531210010	9347141190	RL3515MB01	3515 008 017 0	52		Similar with 03.130.00.40	RL3530RB8	3530 451 008 0	277
6623201858	4758003010	RL3523GB	3523 012 001 0	108		Similar with 03.130.00.41	RL3530RB9A	3530 451 009 0	277
6644297082	4722500000	RL3754PT02	3754 100 002 0	240		Similar with 03.130.00.56	RL3530RB11	3530 451 011 0	277
6934207871	9325000030	RL3511DG	3511 006 007 0	26		03342-56000	RL3516DA	3516 004 001 0	116
6954317405	4613152480	RL3514EA04	3514 013 024 0	81		314013005	RL3531BA	3531 002 001 0	60
6954317405	4613152610	RL3514EA-A	3514 013 001 0	80		314014004	RL3531BA-B	3531 002 004 0	60
6984200047	4230005342	L-5	3530 888 026 9	242		40010140	273092833468	273092833468	323
6984313712	4757145000	RL3523AK-C	3523 002 008 0	110		40010142	273091033468	273091033468	323
6992950018	9700511020	RL1608PR	1608 045 004 0	189		40010143	273091033478	273091033478	323
6994290844	4750103170	RL3512MA22	3512 010 022 0	66		40010154M1D	273092833478	273092833478	323
8633135000	KN0481500101	RL8606JC	8606 013 001 0	211		40010155	274091033468	274091033468	323
A0002540047/Z00	9700514310	RL1608EC01	1608 043 003 0	187		40020238M1D	475091030118M	475091030118M	324
A0002950918	VG3361	RL1608LA	1608 040 001 0	186		4021300120	3509 054 002 8	3509 054 002 8	7
A0002952818	9700514050	RL1608EC13	1608 043 013 0	187		4031300645	3509 054 011 8	3509 054 011 8	7
A0003275125	SV3111	RL8606GA	8606 008 001 0	171		4031302816	3509 054 001 8	3509 054 001 8	7
A0003282030	0500005001000	RL2908MA02	2908 015 002 0	168		4031311016	3509 054 015 1	3509 054 015 1	7
A0003282130	0500005002000	RL2908MA01	2908 015 001 0	167		4031312002	3509 054 010 8	3509 054 010 8	7
A0003284530Z00	4640070110	RL2908GC	2908 007 003 0	166		4421300008	3509 054 003 8	3509 054 003 8	7
A0004300470	0484210001000	RL3754EL03	3754 045 003 0	42		4471310215	3509 054 001 1	3509 054 001 1	7
A0004319005	4612951000	RL3514MH	3514 009 007 0	82		4640060110	RL2908AA13	2908 001 013 0	163

INDEX BY VEHICLE APPLICATIONS

MERCEDES

OEM No.	Cross Ref.	SORL No.	SORL EU No	Page	OEM No.	Cross Ref.	SORL No.	SORL EU No	Page	
	4640060120	RL2908AA14	2908 001 014 0	163		72968	231062631447	231062631447	303	
	4720726390	RLD5-R049	3754 012 050 0	238		72969	232062631447	232062631447	304	
	4750100250	RL3531NA	3531 008 001 0	62		72971	219022633397	219022633397	304	
	4750103150	RL3512MA20	3512 010 020 0	66		72972	212022630757	212022630757	314	
	4757101360	RL3523AB-L	3523 001 157 0	108		72972	212022630757	212022630757	314	
	65677	RL3531FA	3531 005 001 0	60		72981	219012631037	219012631037	304	
	70706	993012630617	993012630617	312		72982	220012631037	220012631037	304	
	70753	220022633397	220022633397	304		72990	219012630537	219012630537	304	
	70754	219022633397	219022633397	304		72991	220012630537	220012630537	304	
	70771	985022633467	985022633467	306		79073	997012630167	997012630167	307	
	70772	984022633467	984022633467	306		79074	998012630167	998012630167	307	
	70775	177012630797	177012630797	295		79099	231012630007	231012630007	303	
	70867	212022630757	212022630757	314		79100	232012630007	232012630007	303	
	70917	232072630947	232072630947	304		79136	998012631557	998012631557	307	
	70918	231082630947	231082630947	303		79137	997012631557	997012631557	307	
	70952	998012631067	998012631067	307		79185	994012631147	994012631147	306	
	70953	997012631067	997012631067	307		79186	942022631507	942022631507	299	
	70954	212012630867	212012630867	314		79203	984022633467	984022633467	306	
	72036	946012630077	946012630077	327		79204	985022633467	985022633467	306	
	72037	945012630077	945012630077	327		79208	231062631447	231062631447	303	
	72038	925012630077	925012630077	320		79209	232062631447	232062631447	304	
	72039	926012630077	926012630077	320		79210	220022633397	220022633397	304	
	72056	994022631507	994022631507	306		79211	219022633397	219022633397	304	
	72059	994012633587	994012633587	306		79211	219022633397	219022633397	304	
	72060	783022633467	783022633467	297		79212	212022630757	212022630757	314	
	72061	782022633467	782022633467	297		79219	219012631037	219012631037	304	
	72062	996022633397	996022633397	319		79220	220012631037	220012631037	304	
	72063	995022633397	995022633397	319		79228	219012630537	219012630537	304	
	72069	231012631017	231012631017	303		79229	220012630537	220012630537	304	
	72070	232012631017	232012631017	303		79429	203011930507	203011930507	298	
	72152	782031020055	782031020055	297		79430	204011930507	204011930507	298	
	72173	231012631447	231012631447	303		79514	231062631447	231062631447	303	
	72174	232012631447	232012631447	304		79515	232062631447	232062631447	304	
	72178	178022631527	178022631527	308		79572	995022633397	995022633397	319	
	72203	203011930507	203011930507	298		79573	996022633397	996022633397	319	
	72204	204011930507	204011930507	298		79656	994022630077	994022630077	306	
	72213	993022633387	993022633387	312		80000	493012631507	493012631507	289	
	72234	996022633397	996022633397	319		80001	492012631507	492012631507	289	
	72235	995022633397	995022633397	319		80008	494022631507	494022631507	289	
	72303	231062631447	231062631447	303		80009	495022631507	495022631507	289	
	72304	232062631447	232062631447	304		80010	491012631507	491012631507	290	
	72308	212022630757	212022630757	314		80012	474012630117	474012630117	290	
	72320	220022633397	220022633397	304		80013	473012630117	473012630117	290	
	72322	212022630757	212022630757	314		80014	488012630117	488012630117	290	
	72455	219012631037	219012631037	304		80031	498102811116	498102811116	291	
	72456	220012631037	220012631037	304		80033	498103731417	498103731417	291	
	72561	984022633467	984022633467	306		80084	493012631507	493012631507	289	
	72562	985022633467	985022633467	306		80085	492012631507	492012631507	289	
	72593	996022633397	996022633397	319		80087	494022631507	494022631507	289	
	72594	995022633397	995022633397	319		80088	495022631507	495022631507	289	
	72596	994012631277	994012631277	306		80092	491012631507	491012631507	290	
	72616	997012631237	997012631237	307		80150	487032830517	487032830517	292	
	72617	998012631237	998012631237	307		80163	493012611507	493012611507	289	
	72731	219012630537	219012630537	304		80164	492012611507	492012611507	289	
	72732	220012630537	220012630537	304		80165	494022611507	494022611507	289	
	72782	782031020055	782031020055	297		80166	495022611507	495022611507	289	
	72809	219012631037	219012631037	304		80176	493012631507	493012631507	289	
	72810	220012631037	220012631037	304		80177	492012631507	492012631507	289	
	72811	219012630537	219012630537	304		80178	494022631507	494022631507	289	
	72812	220012630537	220012630537	304		80179	495022631507	495022631507	289	
	72919	231012630307	231012630307	303		80180	491012631507	491012631507	290	
	72920	232012630307	232012630307	303			Alternative 9254601030	RL3530PE05	3530 390 025 0	265
	72937	231012631017	231012631017	303			Alternative 9254601040	RL3530PE06	3530 390 026 0	265
	72938	232012631017	232012631017	303			Alternative 9254601050	RL3530PE07	3530 390 027 0	265

INDEX BY VEHICLE APPLICATIONS

MERCEDES

OEM No.	Cross Ref.	SORL No.	SORL EU No	Page
	Alternative 9254601070	RL3530PE08	3530 390 028 0	265
	Alternative 9254601080	RL3530PE03	3530 390 029 0	265
	Alternative 9254601090	RL3530PE09	3530 390 030 0	265
	9324000240	RL3511DG02	3511 006 030 0	36
	9325000040	RL3511DG-A	3511 006 008 0	26
	9347023900	RL3515EA07	3515 003 021 0	50
	9700519032	RL1608KA-9	1608 039 001 0-9	194
	9700519452	RL1608EB09-9	1608 044 009 9	195
	9730025000	RL3522BB	3522 002 002 0	121
	9730025060	RL3522BB	3522 002 002 0	121
	APSA5890	RL3526FA	3526 003 001 0	101
	Alternative BS9520	RL3530CB04	3530 060 999 0	262
	DPM64MP	RL3526XD01	3526 043 001 0	98
	EE4106	RL3513GC	3536 009 004 0	75
	I83121	RL3514HA-9	3514 008 000 0-9	92
	I83121	RL3514HB-9	3514 008 001 0-9	92
	I87546	RL3512CB-9	3512 008 002 0-9	25
	I88770R	RL3509AD-A	3509 004 002 0	1
	II14195008	RL1608LA-9	1608 040 001 0-9	195
	KB6540	488012630117	488012630117	290
	SV1281	RL2908DA05	2908 004 005 0	165
	SZ1115	RL2135EA	2135 005 001 0	219
	SZ1159	RL2135EB	2135 005 002 0	220
	ZB4805	RL3511XB01	3511 020 001 0	26
		CM2XL-4SC1	CM2XL-4SC1	156
		CM3XL-4SC1	CM3XL-4SC1	156
		RL1608EB04	1608 043 007 0	187
		RL1608EC07-9	1608 043 007 9	195
		RL3526FA-9	3526 003 002 0-9	105

MITSUBISHI

	642-03080	RL1608AM	1608 001 014 0	184
	642-03080	RL1608AM04	1608 001 106 0	183
	642-03502	RL1608BM05	1608 003 092 0	184
	MC802149	RL3531EA	3512 005 001 0	63
	MC803504	RL3536MA	3536 012 001 0	75
	MC804585	RL3548YA	3548 011 001 0	237
	MC808718	RL3512GN	3512 002 015 0	23
	MC820241	RL3533GB	3533 005 001 0	215
	MC821909	RL3533EA	3533 003 001 0	219
	MC826122	RL3512GP	3512 002 017 0	23
	ME063715	RL3549GB	3549 016 001 0	220
	ME707196	RL3518RC	3518 014 001 0	152

NANJING IVECO

	3519-00605	RL3519AM32	3519 010 182 0	245
	3519-00606	RL3519AM33	3519 010 183 0	245
	3519010RL	RL3519JA55	3519 030 497 0	245
	3519011RL	RL3519JA54	3519 030 496 0	245
	3519010ZYT-D	RL3519AM32	3519 010 182 0	245
	3519011ZYT-D	RL3519AM33	3519 010 183 0	245

NATO

2530123122719	9617231000	RL3526DX07	3526 005 051 0	97
2530123611750	4750103080	RL3512MA10	3512 010 010 0	65
4820123702502	4750103330	RL3512MA33	3512 010 033 0	67
	4231054060	RL3519JA37	3519 030 436 0	249
	9500600030	RL3513FC	3513 006 004 0	73
	9617223050	RL3526CK37	3526 001 037 0	95
	9617234210	RL3526NA38	3526 006 038 0	98

NEOPLAN

OEM No.	Cross Ref.	SORL No.	SORL EU No	Page
042320200	9700511260	RL1608PQ	1608 045 003 0	189
042320800	9700511520	RL1608PH	1608 044 004 0	190
042321100	9700511650	RL1608PJ	1608 044 005 0	190
050113145	4220100100	RL3535FA	3535 001 001 0	220
07010020	4231059000	RL3519JA18	3519 030 142 0	249
07101000	9710025700	RL3518NF	3527 003 006 0	133
07110000	9710021520	RL3518MA	3527 002 001 0	133
07110000	9710021500	RL3518NB	3527 003 002 0	133
07111000	9710025310	RL3518ND	3527 003 004 0	132
07131000	4721950200	RL3518ZC-C	3518 020 006 0	157
07133000	9630010510	RL3520ZD02	3520 504 002 0	136
080240000	4231061060	RL3519AM09	3519 010 192 0	253
102140200	4729000220	RL3754EC111	3754 042 111 0	176
102140210	4729000210	RL3754EC110	3754 042 110 0	176
102140300	4729000010	RL3754EC100	3754 042 100 0	175
102140400	4729000500	RL3754EC120	3754 042 120 0	176
11010080	9700511760	RL1608PA05	1608 044 014 0	190
11014306	BS9520	RL3530CB07	3530 061 027 0	262
11016524	4410500110	RL2908NA01	2908 013 001 0	178
11016529	4729000530	RL3754EC02	3754 042 002 0	173
11017336	4730170010	RL3518KA01	3518 009 033 0	139
11017347	4630131160	RL3548AG22	3548 001 022 0	223
11017354	4750103180	RL3512MA23	3512 010 023 0	66
11017367	4340141000	RL3525HA02	3525 008 002 0	212
11017448	4324200000	RL3511AZ	3511 003 036 0	29
11018619	4324200020	RL3511AZ-A	3511 003 037 0	29
11018632	4613170240	RL3514DG-A	3514 004 008 0	78
110242500	4730170080	RL3518KA-A	3518 009 032 0	139
110250700	4340140010	RL3525HA01	3525 008 001 0	212
1102525543712	4720174810	RL8606JB	8606 011 002 0	211
110264100	4520021310	RL3520AA07	3520 001 007 0	203
110273630	LA6200	RL3511CH-A	3511 005 006 0	32
110275100	4324100200	RL3511AM25	3511 003 155 0	30
1102407543908	4613180490	RL3514DX-D05	3514 004 300 0	79
1102441544303	9753030600	RL3512BG03	3512 007 060 0	19
40320201	9700519042	RL1608PA-9	1608 044 001 0-9	196
40320201	9700519042	RL1608PC-9	1608 045 001 9	196
40320201	9700519042	RL1608PQ-9	1608 045 0030-9	196
40320201	9700519042	RL1608PR-9	1608 045 004 0-9	196
	110170	RL3527GA	3527 006 001 0	126
	4720174800	RL8606JA	8606 011 001 0	211
	70157	177011930797	177011930797	295
	70706	993012630617	993012630617	312
	70753	220022633397	220022633397	304
	70754	219022633397	219022633397	304
	70771	985022633467	985022633467	306
	70772	984022633467	984022633467	306
	72177	177011930797	177011930797	295
	72203	203011930507	203011930507	298
	72204	204011930507	204011930507	298
	72320	220022633397	220022633397	304
	72321	219022633397	219022633397	304
	72518	177011930797	177011930797	295
	72561	984022633467	984022633467	306
	72562	985022633467	985022633467	306
	72971	219022633397	219022633397	304
	72972	212022630757	212022630757	314
	79203	984022633467	984022633467	306
	79204	985022633467	985022633467	306
	79210	220022633397	220022633397	304
	79211	219022633397	219022633397	304
	79429	203011930507	203011930507	298
	79430	204011930507	204011930507	298

INDEX BY VEHICLE APPLICATIONS

NEOPLAN									
OEM No.	Cross Ref.	SORL No.	SORL EU No	Page	OEM No.	Cross Ref.	SORL No.	SORL EU No	Page
	110170	RL3527GA01	3527 006 010 0	126		79112	999111020607	999111020607	322
	AE4158	RL3515LF	3515 007 029 0	46		79160	999031021307	999031021307	322
	AE4168	RL3515LF-A	3515 007 030 0	46		79235	960111010627	960111010627	322
	Alternative BS9520	RL3530CB04	3530 060 999 0	262		79326	999031011307	999031011307	322
						79619	999111010617	999111010617	322
						80020	498111010217	498111010217	291
NISSAN					RVI				
1-48460-198-0		RL3548FB	3548 006 002 0	232	0001108600	9710020000	RL3518NC	3527 003 003 0	133
43431-76000		RL1704DB	1704 004 002 0	227	0024551020	9735000030	RL3516EE	3516 005 003 0	112
45184-Z0003	45300030131	RL3518ED04	3518 005 020 0	131	0037434900	9735000110	RL3516EG	3516 005 005 0	113
45260-Z2000	MC804585	RL3548YA	3548 011 001 0	237	0501006570	9700514230	RL1608EE	1608 042 002 0	187
47502-Z2000	44530-1030	RL3513YA	3536 006 001 0	75	1120353	9700519042	RL1608PA-9	1608 044 001 0-9	196
	45184-90010	RL3518RB	3518 013 002 0	152	23170600	4325000200	RL3515ZA	3511 013 001 0	208
	4721710000	RLD5-R053	3754 012 037 0	239	24733005	9730110000	RL3518ZA	3518 019 001 0	141
	47540-Z0005	RL3512GM	3512 002 013 0	23	24733006	4730170080	RL3518KA-A	3518 009 032 0	139
	63.5713.00	RL1608DB	1608 006 002 0	185	38855200	4231069000	RL3519ZA1	3519 820 001 0	253
	642-03080	RL1608AM	1608 001 014 0	184	4822431430	4341001250	RL3531WA01	3531 013 001 0	61
	642-03502	RL1608BM	1608 003 019 0	184	5000039138	4342080000	RL3533AE	3533 001 005 0	215
	670046	RL1704DA	1704 004 001 0	227	5000039183	4342080290	RL3533LA	3533 009 001 0	217
	79103	678012530905	678012530905	302	5000050272	1642176708	RL1608ZA01	1608 057 001 0	183
	79652	972022530237	972022530237	314	5000121755	9347023400	RL3515EA-C	3515 003 004 0	51
		RL1608AN02	1608 051 002 0	183	5000122053	9735000060	RL3516EH	3516 005 006 0	113
		RL1608BL	1608 004 001 0	183	5000130533	1642176708	RL1608ZA01	1608 057 001 0	183
		RL1608BM01	1608 003 062 0	183	5000295421	4324100202	RL3511KA	3513 001 001 0	40
		RL1609BY03	1608 052 003 0	184	5000296596	4324100002	RL3511AM-9	3511 003 025 9	44
		RL3527AL	3527 001 010 0	131	5000436340	4342080090	RL3533AC	3533 001 003 0	215
NORTH BENZ					RABA				
5062950407		RL1608CK	1608 055 001 0	192	5000464005	4231061060	RL3519AM09	3519 010 192 0	253
	79647	678032431305	678032431305	302	5000514869	9347000400	RL3515HB	3515 005 002 0	57
	79648	986032433525	986032433525	296	5000544905	9617210040	RL3526VB	3526 020 002 0	99
	KX3518015-10	RL3518AC	3518 001 003 0	139	5000560242	4341000022	RL3531WA02-9	3531 013 002 0-9	71
					5000587747	SV3302	RL1705WA	1705 050 001 0	226
					5000589984	4341001240	RL3531WA07	3531 013 005 0	62
					5000673126	9700512090	RL1608PF	1608 046 001 0	191
	72733	888030821057	888030821057	318	5000673571		RL1705JE01	1705 073 001 0	227
	72928	972032021357	972032021357	314	5000716328	HB1219	RL3526WL01	3526 028 001 0	100
	79056	972032030757	972032030757	314	5000716330	9253221550	RL3530SB11	3530 480 221 0	275
	79079	986032030417	986032030417	296	5000716330	9253221550	RL3530SB11	3530 480 221 0	275
	79107	231032020907	231032020907	303	5000716328	HB1219	RL3526WL01	3526 028 001 0	100
	79108	232032020907	232032020907	303	5000787875	9700511240	RL1608PE	1608 053 001 0	191
					5000790025	KN0481500101	RL8606JC	8606 013 001 0	211
					5000790594	4460082300	3550 625 045 0	3550 625 045 0	209
					5000790594	4460000000	3550 625 045 0	3550 625 045 0	209
					5000791021	4640023300	RL2908FA	2908 006 001 0	165
	72614	888012020707	888012020707	318	5000791199	MB4611	RL3514HB17	3514 008 017 0	85
	72888	888012020707	888012020707	318	5000806404	4630360000	RL1705CA	1705 003 001 0	224
	79067	888021020007	888021020007	318	5000809163	9630010120	RL3520ZB	3520 501 002 0	135
					5000809566	4230005342	L-5	3530 888 026 9	242
					5000809875	9710025470	RL3518NE	3527 003 005 0	132
					5000815361	4231079000	RL3519DA51	3519 090 100 0	258
	70824	254031031107	254031031107	311	5000815689	9700511260	RL1608PQ	1608 045 003 0	189
					5000815699	9700511260	RL1608PQ	1608 045 003 0	189
	70882	972031040015	972031040015	313	5000819893	9753034730	RL3512BJ	3512 007 014 0	18
					5000821899	4613150052	RL3514DA-F-9	3514 012 000 0-9	91
	72702	999031011307	999031011307	322	5001000746	4220100120	RL3535FA02	3535 002 002 0	220
					5001829060	MB4613	RL3514HB18	3514 008 018 0	85
	72917	254031021107	254031021107	311	5001830449	4324070120	RL3511EG23	3511 007 023 8	41
					5001842847	9700519442	RL1608PJ-9	1608 044 005 0-9	196
	72935	678011020305	678011020305	302	5001857040	AC598C	RL3522YC02	3522 010 002 0	123
					5001874282	LA8065	RL3511NA16	3511 014 033 0	33
	79097	266061021457	266061021457	329	5001874292	LA8065	RL3511NA16	3511 014 033 0	33
					5010019862	9753035040	RL3512BG04	3512 007 061 0	19

INDEX BY VEHICLE APPLICATIONS

RVI

OEM No.	Cross Ref.	SORL No.	SORL EU No	Page	OEM No.	Cross Ref.	SORL No.	SORL EU No	Page
5010056094	9617231020	RL3526DC	3526 005 003 0	96	5021170462	9730093000	RL3522FA	3522 004 001 0	122
5010056468	4758003010	RL3523GB	3523 012 001 0	108	5021170468	9735000380	RL3516UA01	3516 022 001 0	113
5010056474	4340140010	RL3525HA01	3525 008 001 0	212	5021208564	9710023070	RL3527DB	3527 004 002 0	131
5010067820	AE4412	RL3515LA15	3515 007 115 0	47	5021208761	9710023000	RL3527DF	3527 004 006 0	132
5010067834	9253221550	RL3530SB11	3530 480 221 0	275	5600528058	4757004030	RL3523DA	3523 002 009 0	110
5010135712	4729001010	RL3754EC115	3754 042 115 0	177	5810112384	4729000220	RL3754EC111	3754 042 111 0	176
5010143058	4721950160	RL3550SM24	3550 210 024 0	157	7420745592		RL2908GA32	2908 007 032 0	166
5010143095	4410500110	RL2908NA01	2908 013 001 0	178	7420745639		RL2908GA31	2908 007 031 0	166
5010143097	4729000540	RL3754EC10	3754 042 010 0	174	7420746269		RL2908GA33	2908 007 033 0	166
5010143098	4729051160	RL3754EC-C	3754 044 005 0	177	AI39780001	4757120000	RL3523CB	3523 005 002 0	108
5010145720	9617232080	RL3526DX06	3526 005 100 0	97	G380	LA8016	RL3511NA20	3511 014 038 0	34
5010197213	4729000510	RL3754EC119	3754 042 119 0	176	R385	LA8003	RL3511NA17	3511 014 035 0	33
5010207352	4729000590	RL3754EC117	3754 042 117 0	176		4231054060	RL3519JA37	3519 030 436 0	249
5010207451	9730112050	RL3518ZE	3518 019 006 0	142		4324200000	RL3511AZ	3511 003 036 0	29
5010235153	4729000300	RL3754EC112	3754 042 112 0	176		4324200030	RL3511AZ-B	3511 003 038 0	29
5010249007	4729000210	RL3754EC110	3754 042 110 0	176		72005	983032731557	983032731557	317
5010260033	4614945020	RL3514XD01	3514 022 001 0	87		72006	982032731557	982032731557	317
5010260060		RL2908GA32	2908 007 032 0	166		72090	982032711557	982032711557	317
5010260115	79075	940062711467	940062711467	326		72099	256012730157	256012730157	315
5010260116	79076	941062711467	941062711467	326		72100	678012730007	678012730007	302
5010260136		RL2908GA34	2908 007 034 0	166		72160	983012710637	983012710637	317
5010260213	4640060010	RL2908AD	2908 001 004 0	163		72161	982012710637	982012710637	318
5010260241	AC598C	RL3522YC02	3522 010 002 0	123		72162	983062711557	983062711557	317
5010260390		RL2908GA31	2908 007 031 0	166		72163	982062711557	982062711557	317
5010260640	LA8065	RL3511NA16	3511 014 033 0	33		72318	971012710117	971012710117	310
5010260705	9730112060	RL3518ZA07	3518 019 060 0	141		72319	970012710107	970012710107	309
5010260940	AC598C	RL3522YC02	3522 010 002 0	123		72328	678012733507	678012733507	302
5010268932		RL2908GA33	2908 007 033 0	166		72346	983012710907	983012710907	317
5010422018	4729000740	RL3754EC13	3754 042 013 0	174		72347	982012710907	982012710907	317
5010422315	9254261000	RL3530YY1	3530 630 005 0	263		72347	982012710907	982012710907	317
5010422316	9254261010	RL3530YY2	3530 630 011 0	263		72441	941012713507	941012713507	326
5010422319	9254248000	RL3530YZ4	3530 241 004 0	263		72633	971012711257	971012711257	311
5010422320	9254248010	RL3530YZ5	3530 241 005 0	263		72634	970012711257	970012711257	309
5010422344	4410501000	RLD5-M042	4101 099 002 0	179		72738	983012710647	983012710647	317
5010422351	AE4525	RL3515AH07	3515 023 007 0	56		72739	982012710627	982012710627	318
5010422395	LA8011	RL3511NA19	3511 014 037 0	34		72740	971012830107	971012830107	311
5010422400	DPM28A	RL3526NE-B	3526 006 043 0	98		72741	970012830107	970012830107	310
5010422513	4757111550	RL3523AK04	3523 002 026 0	109		72786	940012711307	940012711307	326
5010422629	LA8065	RL3511NA16	3511 014 033 0	33		72787	941012711307	941012711307	326
5010422971	AE4605	RL3515XD01	3515 026 001 0	48		72798	940012710357	940012710357	326
5010452511	9700514380	RL1608HA10	1608 090 010 0	188		72799	941012710357	941012710357	326
5010452512	9700514220	RL1608EA08	1608 042 023 0	186		72813	940012711057	940012711057	326
5010525505	LA8063	RL3511NA29	3511 014 047 0	35		72814	941012711057	941012711057	326
5010525558	AC574BYW	RL3518SK02	3518 031 002 0	149		72835	970012710117	970012710117	309
5010525808	AE4525	RL3515AH07	3515 023 007 0	56		72836	971012710107	971012710107	310
5010216965	AE4440	RL3515TA03	3515 012 003 0	48		72838	983012711357	983012711357	317
5021170044	4230005352	L-6	3530 888 027 9	242		72839	982012711357	982012711357	317
5021170046	4231039000	RL3519NA	3519 360 001 0	246		72840	972012711037	972012711037	314
5021170081	4324310022	RL3511FA-9	3511 009 101 9	45		72993	940012713507	940012713507	326
5021170084	4325000210	RL3515ZB	3511 013 002 0	208		72994	941012713507	941012713507	326
5021170123	4410328090	3550 301 809 0	3550 301 809 0	158		72997	970012833507	970012833507	310
5021170125	4410329212	3550 305 808 0	3550 305 808 0	159		72998	971012833507	971012833507	311
5021170126	4410329222	3550 305 809 0	3550 305 809 0	159		7420915349	RLD5-Z139	1705 531 001 0	202
5021170180	4630131120	RL3548AG02	3548 001 005 0	223		79000	970012713517	970012713517	310
5021170185	SV1318	RL2908CB	2908 003 002 0	164		79001	971012713517	971012713517	311
5021170197	4721950310	RL3518ZC	3518 020 001 0	157		79007	983032731557	983032731557	317
5021170198	4721950410	RL3518ZZ	3518 020 003 0	156		79008	982032731557	982032731557	317
5021170231	4757120002	RL3523CA-9	3523 005 0019-1	111		79010	982032711557	982032711557	317
5021170236	4757150002	RL3523BB-9	3523 005 004 0-9	111		79011	256012730157	256012730157	315
5021170262	8946011322	3550 430 002 0	3550 430 002 0	160		79012	678012730007	678012730007	302
5021170427	9630010520	RL3520ZD01	3520 504 001 0	136		79013	983012710637	983012710637	317
5021170428	9630060010	RL3520ZC	3520 501 003 0	136		79014	982012710637	982012710637	318
5021170442	9710021510	RL3518MB	3527 002 002 0	133		79015	983062711557	983062711557	317
5021170448	9710028050	RL3527DE07	3527 004 007 0	132		79016	982062711557	982062711557	317

INDEX BY VEHICLE APPLICATIONS

RVI

OEM No.	Cross Ref.	SORL No.	SORL EU No	Page
	79017	971012710117	971012710117	310
	79018	970012710107	970012710107	309
	79019	678012733507	678012733507	302
	79020	983012710907	983012710907	317
	79021	982012710907	982012710907	317
	79021	982012710907	982012710907	317
	79077	940062711457	940062711457	326
	79078	941062711457	941062711457	326
	79124	983012730637	983012730637	317
	79125	982012730637	982012730637	318
	79256	983062711567	983062711567	317
	79257	982062711567	982062711567	317
	79286	983012710647	983012710647	317
	79287	982012710627	982012710627	318
	79288	971012830107	971012830107	311
	79289	970012830107	970012830107	310
	79294	940012710357	940012710357	326
	79295	941012710357	941012710357	326
	79296	940012711057	940012711057	326
	79297	941012711057	941012711057	326
	79299	970012710117	970012710117	309
	79300	971012710107	971012710107	310
	79301	983012711357	983012711357	317
	79302	982012711357	982012711357	317
	79303	972012711037	972012711037	314
	79304	970012833507	970012833507	310
	79305	971012833507	971012833507	311
	79306	970012713517	970012713517	310
	79307	971012713517	971012713517	311
	79310	940062711457	940062711457	326
	79311	941062711457	941062711457	326
	79312	983012730637	983012730637	317
	79313	982012730637	982012730637	318
	79440	940012713507	940012713507	326
	79465	970012733507	970012733507	310
	79466	971012733507	971012733507	310
	79525	983012711007	983012711007	317
	79526	982012711007	982012711007	318
	79535	983062711567	983062711567	317
	79536	982062711567	982062711567	317
	79683	970012733507	970012733507	310
	79684	971012733507	971012733507	310
	Alternative 9254921020	RL3530SB19	3530 480 098 0	275
	9630010500	RL3520ZD03	3520 504 003 0	136
	9700514130	RL1608EF	1608 042 003 0	187
	9700514570	RL1608EH31	1608 042 031 0	188
	AC577A	RL3518AC01	3518 035 001 0	143
	AC574AXY	RL3518SK01	3518 031 001 0	149
	AE1122	RL2908YA01	2908 011 001 0	168
	AE4158	RL3515LF	3515 007 029 0	46
	EE4106	RL3513GC	3536 009 004 0	75
	HB1242	RL3526QL01	3526 030 001 0	100
	LA8004	RL3511NA18	3511 014 036 0	34
	LA8008	RL3511NA02	3511 014 005 0	33
	LA8027	RL3511NA21	3511 014 039 0	34
	LA8040	RL3511NA23	3511 014 041 0	34
	LA8044	RL3511NA24	3511 014 042 0	34
	LA8057	RL3511NA26	3511 014 044 0	35
	LA8060	RL3511NA27	3511 014 045 0	35
	LA8064	RL3511NA30	3511 014 048 0	35
	SV3115	RL8606GB	8606 008 002 0	171
SAB				
	70576	972031020015	972031020015	313

OEM No.	Cross Ref.	SORL No.	SORL EU No	Page	
	70882	972031040015	972031040015	313	
	70887	972031040615	972031040615	314	
SAE					
	72837	986011010637	986011010637	297	
	79005	999111011307	999111011307	322	
	79149	999111021307	999111021307	322	
	79331	999111011307	999111011307	322	
	79346	999111031307	999111031307	322	
	79649	999111021117	999111021117	322	
	80124	476011010117	476011010117	293	
	80125	477011010117	477011010117	293	
	80129	476011010217	476011010217	293	
	80130	477011010217	477011010217	293	
SAF					
	70802	970031021107	970031021107	309	
	70803	971031021107	971031021107	310	
	72053	972011020207	972011020207	314	
	72250	888031011327	888031011327	318	
	72254	888031011287	888031011287	318	
	72334	972031021127	972031021127	313	
	72554	972031041117	972031041117	313	
	72645	999031020457	999031020457	322	
	72703	999031020507	999031020507	322	
	72710	972011010457	972011010457	313	
	72763	999031021107	999031021107	322	
	72863	888031011337	888031011337	318	
	72883	999031021507	999031021507	322	
	72889	999031011507	999031011507	322	
	72948	888111011307	888111011307	318	
	79005	999111011307	999111011307	322	
	79043	970061011447	970061011447	309	
	79044	971061011447	971061011447	310	
	79090	972031010127	972031010127	314	
	79149	999111021307	999111021307	322	
	79321	888031011327	888031011327	318	
	79325	999031020457	999031020457	322	
	79327	999031020507	999031020507	322	
	79328	972011010457	972011010457	313	
	79329	986021013527	986021013527	296	
	79331	999111011307	999111011307	322	
	79336	970061011447	970061011447	309	
	79337	971061011447	971061011447	310	
	79342	972031010127	972031010127	314	
	79346	999111031307	999111031307	322	
	79502	972011020207	972011020207	314	
	80018	498111030817	498111030817	291	
	80022	498111010417	498111010417	291	
	80041	498111030817	498111030817	291	
	80094	487032830515	487032830515	292	
SAURER					
	4454106900	4235060020	RL3519AM37	3519 010 290 0	245
		70762	972011950507	972011950507	313
		70764	972011950007	972011950007	313
SCANIA					
	0426380	SV1295	RL2908CA	2908 003 001 0	164
	1010125	4756040110	RL3520AB	3520 002 001 0	203

INDEX BY VEHICLE APPLICATIONS

SCANIA

OEM No.	Cross Ref.	SORL No.	SORL EU No	Page	OEM No.	Cross Ref.	SORL No.	SORL EU No	Page
1010126	4756040130	RL3520DA	3520 003 001 0	203	1518349	KW1223.6	3509 051 005 9	3509 051 005 9	13
1010153	4231049000	RL3519YA1	3519 810 001 0	248	1518353	KY1564.1	3509 051 005 1	3509 051 005 1	13
1010154	4231069000	RL3519ZA1	3519 820 001 0	253	1518356	KW3127.1	3509 051 001 8	3509 051 001 8	13
1010155	4231079000	RL3519DA51	3519 090 100 0	258	1518372	KZ126.1SP	3509 051 003 1	3509 051 003 1	13
1019361	4230005342	L-5	3530 888 026 9	242	1518374		3509 051 002 1	3509 051 002 1	13
1019575	4230005352	L-6	3530 888 027 9	242	1519035	5340170090	RL3533NA01	3533 012 001 0	218
1105670	4729000060	RL3754EC103	3754 042 103 0	175	1521394		RLD5-Z112	1705 508 001 0	200
1118884		RL2908EG	2908 005 007 0	167	1543187	4324070600	RL3754AA01	3754 042 005 0	41
124978	4520021070	RL3520AA	3520 001 001 0	203	1676783	9735000130	RL3516EX	3516 005 013 0	113
1308511	284358	RL3512GL	3512 002 010 0	23	1678516	RCCS00031	RL3509DH-D	3509 034 001 0	4
1313854	4324070700	RL3511AD020	3511 003 005 8	41	1697318	4757100012	RL3523AA-A-9	3523 001 019 0-9	111
1314047	4613150080	RL3514DS	3514 004 025 0	78	1698848		3509 005 005 9	3509 005 005 9	8
1319557	1319557	RL1705JA01	1705 060 001 0	227	1727377		RLD5-Z130	1705 522 001 0	201
1322814	KW3127.1	3509 051 001 8	3509 051 001 8	13	1734996	BS8500	RL3530MS01	3530 840 001 0	263
1322986	9730110000	RL3518ZA	3518 019 001 0	141	1738442	9710028050	RL3527DE07	3527 004 007 0	132
1324425	9617231220	RL3526XB01	3526 041 001 0	100	1738458	4410329222		3550 305 809 0	159
1324664	0481064603000	RL3514SA	3514 014 000 0	88	1738469	4630840000	RL3548KA	3548 018 001 0	171
1331770	622199AM	RL1608XD	1608 050 002 0	182	1738474	4640061010	RL2908AA10	2908 001 010 0	163
1332658	8942600402	K2422	3511 012 003 0	42	1738495	9735000380	RL3516UA01	3516 022 001 0	113
1335185		RL3518ZA-9	3518 019 001 0-9	154	1747895	622199AM	RL1608XD	1608 050 002 0	182
1335185		RL3518ZE-A-9	3518 019 008 0-9	154	1774426	8946011322		3550 430 002 0	160
1335961	4722500000	RL3754PT02	3754 100 002 0	240	1784588	4410329212		3550 305 808 0	159
1338345	4729000090	RL3754EC106	3754 042 106 0	175	1784590	4410329632		3550 307 003 0	159
1338893	9730090002	RL3522FB-9	3522 004 002 0-9	124	1788946	9522010020	RL3521EA01	3521 014 001 0	206
1339907	9735000000	RL3516ED	3516 005 002 0	112	1788954	9735000510	RL3516XA01	3516 020 001 0	113
1339908	4758003010	RL3523GB	3523 012 001 0	108	1788960	4721717060	RLD5-R055	3754 012 048 0	239
1342598	9730110500	RL3518ZA77	3518 019 077 0	141	1796663	K016615KT	RL3509DH-A	3509 031 001 0	4
1344213	9349010022	RL3515EA-C-9	3515 003 004 0-9	58	186568	9735000140	RL3516BH01	3516 002 039 0	112
1350096	9730090100	RL3522FB	3522 004 002 0	123	202213	4528020000	RL3521CC	3521 006 002 0	207
1350477	9617230012	RL3526BA-9	3526 004 0019-1	104	262083	5710400000	RL1705PA01	1705 056 001 0	225
1356634		RL3512MA18	3512 010 018 0	66	279771	500005001	RL2908MA02	2908 015 002 0	168
1356635	9347023870	RL3515EA04	3515 003 018 0	50	279772	500005002	RL2908MA01	2908 015 001 0	167
1365414	4729001020	RL3754EC116	3754 042 116 0	177	282501	9730020042	RL3522AH-9	3522 001 001 9	124
1367453	629683AM	RL1604AA03	1604 001 003 0	182	282508	4630130042	RL3548AF-9	3548 001 004 0-9	229
1372186	4729000520	RL3754EC118	3754 042 118 0	176	282508	4630130042	RL3548AG-9	3548 001 003 0-9	229
1372917	9254321050	RL3530SA1	3530 480 025 0	275	285903	9343000030	RL3513BB	3536 001 001 0	74
1373080	4342050320	RL3548UB01	3548 038 001 0	222	285903	9343000010	RL3513BB02	3536 001 008 0	74
1376272	SEB01033004	3509 031 002 9	3509 031 002 9	14	293139	9730024020	RL3522AH	3522 001 001 0	121
1376793	4721950180	RL3550FA	3550 210 018 0	157	293546	275491	RL3512GL-C	3512 002 018 0	23
1379941	4410500110	RL2908NA01	2908 013 001 0	178	295498	4750103130	RL3512MA15	3512 010 015 0	65
1381454	4729000120	RL3754EC107	3754 042 107 0	175	305416	9730024230	RL3522AZ-A	3522 001 011 0	121
1383955	4729000610	RL3754EC09	3754 042 009 0	173	307605	9347023810	RL3515EA-H	3515 003 008 0	51
1383956	4729000620	RL3754EC04	3754 042 004 0	173	3097151	SEB00967004	3509 031 002 8	3509 031 002 8	14
1383957	4729001130	RL3754EC18	3754 042 018 0	175	318158	4750103020	RL3512MA04	3512 010 004 0	64
1383958	4729001120	RL3754EC17	3754 042 017 0	175	318158	4522002210	RL3521BA-A	3521 004 002 0	205
1399776	4640070100	RL2908GA	2908 007 001 0	165	318159	4522002220	RL3521BC	3521 004 005 0	205
1404397	4729001130	RL3754EC18	3754 042 018 0	175	319480	9347020062	RL3515EA-D-9	3515 003 005 0-9	58
1408332	9617232170	RL3526XB03	3526 041 003 0	100	319859	9617020012	RL3526PB-9	3526 008 002 0-9	105
1421186	629683AM	RL1604AA03	1604 001 003 0	182	319859	9617020012	RL3526PC-9	3526 008 003 0-9	105
1423566	1423566	RL3754ES02	3754 101 002 0	238	325167	4528020032	RL3521CA-9	3521 006 001 9	207
1424404	4520021310	RL3520AA07	3520 001 007 0	203	330302	9522000220	RL3521BD-A	3521 005 005 0	206
1424766	SEB01444004	3509 031 002 1	3509 031 002 1	14	333851	275491	RL3512GL-C	3512 002 018 0	23
1425183	9730110050	RL3518ZF	3518 019 004 0	141	339792	4640060020	RL2908AA	2908 001 001 0	163
1427480	BS8500	RL3530MS01	3530 840 001 0	263	343362	9700511070	RL1608PL	1608 045 005 0	191
1431049	9347142110	RL3515MB02	3515 008 041 0	52	362424	9730025220	RL3522BH02	3522 002 021 0	122
1441235		RLD5-Z131	1705 523 001 0	201	371612	622190AM	RL1608XC	1608 050 003 0	181
1441751	4324100830	RL3511AM01-A	3511 003 143 0	30	373397	4528020090	RL3521CA	3521 006 001 0	207
1441751	4324100810	RL3511AM33	3511 003 184 0	31	373402	4528050040	RL3521CD04	3521 007 004 0	207
1453164	4729051180	RL3754EC-A	3754 044 001 0	177	374116	622190AM	RL1608XC	1608 050 003 0	181
1457303	35TAA-50030	RL3529TA17	3529 003 017 0	17	390286	9617223140	RL3526CK05	3526 001 113 0	95
1488083		RL3754ES01	3754 101 001 0	238	392234	4341000022	RL3531WA01-9	3531 013 001 0-9	71
1503897	4342050320	RL3548UB01	3548 038 001 0	222	400555	9617011000	RL3526PA	3526 008 001 0	99
1513717	629683AM	RL1604AA03	1604 001 003 0	182	400555	9617011050	RL3526PD	3526 008 004 0	99
1516660	9254612900	RL3530YX11	3530 850 001 0	266	405673	9617210040	RL3526VB	3526 020 002 0	99

INDEX BY VEHICLE APPLICATIONS

SCANIA

OEM No.	Cross Ref.	SORL No.	SORL EU No	Page	OEM No.	Cross Ref.	SORL No.	SORL EU No	Page
411010	4750103090	RL3512MA11	3512 010 011 0	65		72660	981051043088	981051043088	305
436190		RL3526BK	3526 002 112 0	93		72661	980051043088	980051043088	305
469052	DX80D	RL3514HB23	3514 008 023 0	79		72662	986051043088	986051043088	296
492273	DX80E	RL3514HB21	3514 008 021 0	79		72663	978011040738	978011040738	308
550457	9700519062	RL1608PE-9	1608 053 010 9	196		72664	979011040738	979011040738	308
550457	9700519062	RL1608PL-9	1608 053 011 9	196		72665	979011040588	979011040588	308
571181	KZ433.1	RL3509BE	3509 051 001 0	4		72666	978011040588	978011040588	308
571181	KZ642.1	RL3509BE	3509 051 001 0	4		72727	935011030928	935011030928	325
575180	622199AM	RL1608XD	1608 050 002 0	182		72728	936011030928	936011030928	325
5751843	622190AM	RL1608XC	1608 050 003 0	181		72729	268011030628	268011030628	329
631697	4325000200	RL3515ZA	3511 013 001 0	208		72730	269011030628	269011030628	329
638768	9617010002	RL3526PA-9	3526 008 003 9	105		72745	263041033058	263041033058	329
638771	4613070022	RL3514MA-9	3514 009 000 9	92		72746	936101031025	936101031025	325
	03342-56000	RL3516DA	3516 004 001 0	116		72747	935101031025	935101031025	325
	1189392	RL3512GA	3512 002 001 0	22		72807	923011040558	923011040558	324
	279950	RL3514LA	3514 015 000 0	85		72808	924011040558	924011040558	324
	280915000	RL3512GA-9	3512 002 101 9	25		72825	351011040848	351011040848	294
	280915	RL3512GB-9	3512 002 102 9	25		72826	352011040848	352011040848	294
	295358	RL3533GC	3533 004 002 0	215		72851	927011040628	927011040628	321
	4324102262	RL3511HA	3513 001 004 0	40		72892	568011030848	568011030848	305
	4324109262	RL3511HA	3513 001 004 0	40		72893	567011030848	567011030848	305
	4324109272	RL3511HA	3513 001 004 0	40		72910	678041033058	678041033058	301
	4640060110	RL2908AA13	2908 001 013 0	163		72947	986041033058	986041033058	296
	4757101360	RL3523AB-L	3523 001 157 0	108		72949	981041033108	981041033108	305
	622785AM	RL1608XA	1608 049 001 0	181		72950	980041033108	980041033108	305
	70573	256031070755	256031070755	315		72956	936101031028	936101031028	325
	70598	972031030708	972031030708	313		72957	935101031028	935101031028	325
	70664	924011030558	924011030558	324		72963	986041033058	986041033058	296
	70665	923011030558	923011030558	324		72995	927011041408	927011041408	321
	70670	936101031025	936101031025	325		72996	928011041408	928011041408	321
	70671	935101031025	935101031025	325		79033	927011040848	927011040848	321
	70801	986041033058	986041033058	296		79105	923011040558	923011040558	324
	70864	986041033058	986041033058	296		79106	924011040558	924011040558	324
	70878	981041033108	981041033108	305		79275	979041033345	979041033345	308
	70879	980041033108	980041033108	305		79442	927011040848	927011040848	321
	72001	979011030588	979011030588	308		79550	927011041408	927011041408	321
	72029	936031041255	936031041255	325		79551	928011041408	928011041408	321
	72236	936101031028	936101031028	325		79677	979041033345	979041033345	308
	72237	935101031028	935101031028	325		811014	888031021375	888031021375	318
	72247	351011030808	351011030808	294		9347023900	RL3515EA07	3515 003 021 0	50
	72248	352011030808	352011030808	294		9630010500	RL3520ZD03	3520 504 003 0	136
	72249	972031020017	972031020017	313		A-6913	RLD5-Z100	1705 502 002 0	199
	72467	986051033088	986051033088	296		A-6915	RLD5-Z101	1705 502 001 0	199
	72468	567011030848	567011030848	305		AC577A	RL3518AC01	3518 035 001 0	143
	72469	568011030848	568011030848	305		I86534	RL2908CA-9	2908 003 001 0-9	169
	72476	979011030588	979011030588	308		I86534	RL2908CB-9	2908 003 002 0-9	169
	72477	978011030588	978011030588	308		K001119V	RL3509DJ	3509 036 001 0	3
	72482	936011031028	936011031028	325			RL1604AA01	1604 001 001 0	182
	72483	935011031028	935011031028	325			RL3511KB	3513 001 002 0	40
	72487	979011030738	979011030738	308			RLD5-Z090	1705 506 001 0	202
	72488	351011030848	351011030848	294					
	72489	352011030848	352011030848	294					
	72491	981051033088	981051033088	305					
	72492	980051033088	980051033088	305	SCHMITZ				
	72579	935011030928	935011030928	325	051428	4528020090	RL3521CA	3521 006 001 0	207
	72580	936011030928	936011030928	325	052190	9630010510	RL3520ZD02	3520 504 002 0	136
	72620	978011040738	978011040738	308	052504	9710023000	RL3527DF	3527 004 006 0	132
	72621	979011040738	979011040738	308	052509	BS9404	RL3530PP03	3530 390 171 0	262
	72624	981051043088	981051043088	305	052539	4410500110	RL2908NA01	2908 013 001 0	178
	72625	980051043088	980051043088	305	052540	4729000550	RL3754EC07	3754 042 007 0	173
	72626	978011040588	978011040588	308	052703	4729051140	RL3754EB-B	3754 044 002 0	177
	72627	979011040588	979011040588	308	052738	4729000580	RL3754EC11	3754 042 011 0	174
	72630	351011040848	351011040848	294	7788088000	4460083902	3550 625 045 8	3550 625 045 8	209
	72631	352011040848	352011040848	294	80251720000	4630320200	RL8606BA	8606 002 001 0	171
					8283011000	4757155000	RL3523BB	3523 005 004 0	110

INDEX BY VEHICLE APPLICATIONS

SCHMITZ

OEM No.	Cross Ref.	SORL No.	SORL EU No	Page
8283012000	9630010510	RL3520ZD02	3520 504 002 0	136
82832250000	4721271400	RLD5-R061	3754 055 001 0	240
82836370000	4640023300	RL2908FA	2908 006 001 0	165
82836370000	4640060020	RL2908AA	2908 001 001 0	163
82839440002	9710023000	RL3527DF	3527 004 006 0	132
82854990000	4640061000	RL2908AA07	2908 001 007 0	163
86331010000	4720174800	RL8606JA	8606 011 001 0	211
	4410507182	RL2908NA01-8	2908 013 001 8	170
	4750103030	RL3512MA05	3512 010 005 0	64

SHAANXI AUTO

OEM No.	Cross Ref.	SORL No.	SORL EU No	Page
81.51101.6455	N/A	RL3519DB-A	3519 120 028 0	254
QT75AQ26-3519010		RL3519AM40	3519 010 461 0	246
QT75AQ26-3519020		RL3519AM41	3519 010 462 0	246
HD90009368000		RL3519JA56	3519 030 516 0	244
HD90009368001		RL3519JA57	3519 030 517 0	244

SISU

OEM No.	Cross Ref.	SORL No.	SORL EU No	Page
	70851	678011051155	678011051155	301
	79002	231012643557	231012643557	303
	79003	232012643557	232012643557	303
	79396	923012643557	923012643557	324
	79397	924012643557	924012643557	324
	79663	924012641017	924012641017	324

TATA

OEM No.	Cross Ref.	SORL No.	SORL EU No	Page
264129200112	N/A	RL1609BH	1608 003 020 0	184
HCV	M303510	RL3511ZA01	3511 015 001 0	35
HCV	M305870	RL3511ZA03	3511 015 003 0	35
Novus 5542	K001242	RL3515QA01	3515 016 001 0	48
	102626	RL3518JC	3518 021 003 0	145
	72858	256012530408	256012530408	315
	80072	487092410515	487092410515	292
	80075	487092410505	487092410505	292
	N/A	RL1608BM02	1608 003 064 0	184

TATRA

OEM No.	Cross Ref.	SORL No.	SORL EU No	Page
	N/A	RL3514GC	3514 007 001 0	83
	79510	970032630357	970032630357	310
	79511	971032630357	971032630357	310
T163/T815	LA8028	RL3511NA22	3511 014 040 0	34

TBK

OEM No.	Cross Ref.	SORL No.	SORL EU No	Page
	K412-93900Z10	RL3519AK	3519 010 477 0	246
	K412-94000Z10	RL3519AK-A	3519 010 478 0	246
	K412-94300Z10	RL3530AK	3530 010 902 0	267
	K412-94400Z10	RL3530AK-A	3530 010 903 0	267

TEREX - DEMAG

OEM No.	Cross Ref.	SORL No.	SORL EU No	Page
63527940	4613159282	RL3514DX-D09	3514 004 200 9	91
63527940	4613170020	RL3514DX	3514 004 033 0	78
00046112	4750103040	RL3512MA06	3512 010 006 0	64

TVS

OEM No.	Cross Ref.	SORL No.	SORL EU No	Page
	263243700109	RL3514DX-D30	3514 004 330 0	88
	263243700163	RL3514XC01	3514 021 001 0	88
	M250780	RL3530CA33	3530 060 154 0	272
	M250940	RL3530NZ1	3530 360 010 0	268
	M250950	RL3530NZ2	3530 360 011 0	268
	M251840	RL3530RA14	3530 450 018 0	269

OEM No.	Cross Ref.	SORL No.	SORL EU No	Page
	M251850	RL3530RA13	3530 450 017 0	269
	M30294	RL3515RA01	3515 014 001 0	52
	M303510	RL3511ZA01	3511 015 001 0	35
	M303751	RL3526YL02	3526 029 002 0	101
	M304930	RL3518GB04	3518 007 043 0	151
	M304941	RL3511XA02	3511 018 002 0	26
	M304950	RL3526YL01	3526 029 001 0	101
	M305201	RL3511XA01	3511 018 001 0	26
	M305840	RL3518GB03	3518 007 042 0	151
	M305850	RL3518GB02	3518 007 041 0	151
	M305870	RL3511ZA03	3511 015 003 0	35
	M600900	RL3514DX-D32	3514 004 332 0	88
	M600920	RL3514DX-D30	3514 004 330 0	88
	M600960	RL3514DX-D31	3514 004 331 0	88
	M601010	RL3514DX-D33	3514 004 333 0	88

VOLVO

OEM No.	Cross Ref.	SORL No.	SORL EU No	Page
0052365395	4341001250	RL3531WA01	3531 013 001 0	61
0351949		6043811025	6043811025	332
0351950		6043821025	6043821025	332
1605860	9253224240	RL3530SB1	3530 480 031 0	275
1030-61320	103061	RL3599AB	3599 001 009 0	129
1068951	169297	RL1705MA01	1705 054 001 0	227
1075765	AE4452	RL3515CA06	3515 001 006 0	46
1079666	4721950180	RL3550FA	3550 210 018 0	157
1082030	4324311910	RL3511FA	3511 009 001 0	27
1082480	4637031070	RL3506FA	3506 004 001 0	73
1082666	9730110000	RL3518ZA	3518 019 001 0	141
11018647	9710020000	RL3518NC	3527 003 003 0	133
1132041	4630131140	RL3548AG	3548 001 003 0	223
1134344	4341001240	RL3531WA07	3531 013 005 0	62
1137213	4613240160	RL3514DA-G	3514 012 001 0	77
11706487	9710020062	RL3518NC-9	3527 003 003 0-9	138
1193532	275491	RL3512GL-C	3512 002 018 0	23
1196983	8997605104	3550 301 815 4	3550 301 815 4	160
11993596	4630130042	RL3548AF-9	3548 001 004 0-9	229
1505035	4637031000	RL3506AD	3506 001 003 0	74
1505044	4342080090	RL3533AC	3533 001 003 0	215
1505047	275491	RL3512GL-C	3512 002 018 0	23
1505064		RL3521BA	3521 004 001 0	204
1509055	9617020010	RL3526PB	3526 008 002 0	99
1521371		RL1608VA05	1608 058 005 0	181
1521394	1521394	RLD5-Z112	1705 508 001 0	200
1521492	4411005312	RL1608EC04-8	1608 043 004 8	187
1576736	4640023300	RL2908FA	2908 006 001 0	165
1580313	4341002210	RL3531WA04	3531 013 003 0	62
1591031	4325000200	RL3515ZA	3511 013 001 0	208
1598586	9617223050	RL3526CK37	3526 001 037 0	95
1587070	0481009026000	RL3531GA	3531 010 001 0	60
1606720	4750100090	RL3531NB	3531 008 002 0	63
1607728	4640060000	RL2908AB	2908 001 002 0	163
1607836	4757100060	RL3523AB10	3523 001 110 0	107
1607889	275491	RL3512GL-C	3512 002 018 0	23
1607887	9730025210	RL3522BJ-A	3522 002 011 0	122
1610566		RL3754ET01	3754 102 001 0	240
1613328	4613150420	RL3514DS-E	3514 004 052 0	78
1622573	4528050040	RL3521CD04	3521 007 004 0	207
1625753	4757101210	RL3523AB02	3523 001 102 0	107
1628491	MB4690	RL3514HD	3514 008 003 0	86
1628955	4757111080	RL3523AK	3523 002 001 0	109
1628955	4757110750	RL3523AK01	3523 002 019 0	109
1629927	4324200020	RL3511AZ-A	3511 003 037 0	29
1653156	1653156	RL3548TC01	3548 022 001 0	228

INDEX BY VEHICLE APPLICATIONS

VOLVO

OEM No.	Cross Ref.	SORL No.	SORL EU No	Page	OEM No.	Cross Ref.	SORL No.	SORL EU No	Page
1655435		RL1608VA05	1608 058 005 0	181	3944186	338050101	RL8606DA	8606 004 001 0	171
1655853	4630490500	RLD5-Z113	1705 509 001 0	199	3944250	275491	RL3512GL-C	3512 002 018 0	23
1655854	4630550500	RLD5-Z118	1705 510 001 0	199	3944716	050110003100	RL3754EL01	3754 045 001 0	177
1665981	4630550520	RLD5-Z120	1705 512 001 0	200	3944715	050110003100	RL3754EL01	3754 045 001 0	177
1669324		RL1705TA01	1705 055 001 0	227	3944719	050110005200	RL3754EL04	3754 045 004 0	178
1668501		RL1608VA05	1608 058 005 0	181	400091	4324070120	RL3511EG23	3511 007 023 8	41
1671953		RL1608VA05	1608 058 005 0	181	4822431	9617210040	RL3526VB	3526 020 002 0	99
1672231		RL1705TA03	1705 055 003 0	227	5003084	9253224240	RL3530SB1	3530 480 031 0	275
1695943	4613245200	RL3514DA-R	3514 012 002 0	77	526031307000	4230005342	L-5	3530 888 026 9	242
1696150	4613074790	RL3514MB	3514 009 001 0	82	526031314000	4637031080	RL3506FC	3506 004 003 0	74
1697318	4757100012	RL3523AA-A-9	3523 001 019 0-9	111	526031314020	4637031050	RL3506AB	3506 001 002 0	73
20356554	4729000560	RL3754EC01	3754 042 001 0	173	527331288000	4750103050	RL3512MA07	3512 010 007 0	64
20382309	9347147400	RL3515XC01	3515 025 001 0	55	589990049970	4720174810	RL8606JB	8606 011 002 0	211
20382312	4750150630	RL3531MA08	3531 007 008 0	63	6210724	4341000022	RL3531WA01-9	3531 013 001 0-9	71
20392040	050110005200	RL3754EL04	3754 045 004 0	178	6212188	4231069000	RL3519ZA1	3519 820 001 0	253
20452151	9347147400	RL3515XC01	3515 025 001 0	55	6213539	4528020090	RL3521CA	3521 006 001 0	207
20453076	4630360160	RL1705CA08	1705 003 008 0	224	6213539	4528020000	RL3521CC	3521 006 002 0	207
20488052	20488052	RLD5-Z112	1705 508 001 0	200	6226178	4730170002	RL3518KM-9	3518 009 025 0-9	154
20488058		RLD5-Z123	1705 515 001 0	200	6231643	4613072000	RL3514MA	3514 009 000 0	82
20488061		RLD5-Z122	1705 514 001 0	200	6626859	4750103020	RL3512MA04	3512 010 004 0	64
20488063		RLD5-Z121	1705 513 001 0	200	6645266	4630131120	RL3548AG02	3548 001 005 0	223
20493844		RLD5-Z121	1705 513 001 0	200	6702610	9617230040	RL3526BA07	3526 004 155 0	93
20553336	4324101920	RL3511AM39	3511 003 192 0	30	6773736	4630320200	RL8606BA	8606 002 001 0	171
20568396	MB4690	RL3514HD	3514 008 003 0	86	6778243	9753030600	RL3512BG03	3512 007 060 0	19
20716313	9347147400	RL3515XC01	3515 025 001 0	55	6789355	9753034730	RL3512BJ	3512 007 014 0	18
20742000	K001330	RL3509AN-D	3509 014 005 0	2	6888509	4522002210	RL3521BA-A	3521 004 002 0	205
20745320	35TAA-50030	RL3529TA17	3529 003 017 0	17	6888511	4522002220	RL3521BC	3521 004 005 0	205
20746465		RL2908GA34	2908 007 034 0	166	720424148	92528	RL3513EF01	3513 500 001 0	41
20755195	9347147400	RL3515XC01	3515 025 001 0	55	720424148	93522	RL3513EF01	3513 500 001 0	41
20773824	92528	RL3513EF01	3513 500 001 0	41	720424148	78964	RL3513EF01	3513 500 001 0	41
20812661	9700512260	RL1608PF01	1608 046 003 0	191	79379137	4342080000	RL3533AE	3533 001 005 0	215
20850557	K013741N00	RL2908MB	2908 016 001 0	179	8030222	SV1295	RL2908CA	2908 003 001 0	164
20858630	4750103130	RL3512MA15	3512 010 015 0	65	8112781	KZ433.1	RL3509BE	3509 051 001 0	4
20858630	4750103240	RL3512MA16	3512 010 016 0	65	8112781	KZ642.1	RL3509BE	3509 051 001 0	4
21795800	4342080290	RL3533LA	3533 009 001 0	217	8113270	1135564	RL3509DH	3509 030 001 0	4
25328737	9730112060	RL3518ZA07	3518 019 060 0	141	8119270	1135564	RL3509DH	3509 030 001 0	4
268759	4630220200	RL3548MA	3548 015 001 0	223	8141934	4640070020	RL2908GB	2908 007 002 0	165
270492	8942600432	K2442	3511 012 007 0	42	8143448	338050101	RL8606DA	8606 004 001 0	171
270617	4757110002	RL3523AK-9	3523 002 0019-1	111	8152899	AE4428	RL3515LF-E	3515 007 043 0	47
270617	4757110002	RL3523AK-A-9	3523 002 006 0-9	111	8171722	627805AM	RL1608XC02	1608 050 014 0	182
270890	4613159002	RL3514DS-9	3514 004 0259-1	91	8552063	4324100202	RL3511KA	3513 001 001 0	40
270890	4613159002	RL3514DS-D-9	3514 004 047 9	91	B6	AE4427	RL3515LF-D	3515 007 042 0	46
270890	4613159002	RL3514DS-F-9	3514 004 052 9	91	B7R	0501100029000	RL3754EL05	3754 045 005 0	178
270969	4613150052	RL3514DA-F-9	3514 012 000 0-9	91	B10M	0501100029000	RL3754EL05	3754 045 005 0	178
272571	4613070022	RL3514MA-9	3514 009 000 9	92	FL10	0481009047000	RL3531GA10	3531 010 010 0	60
272799	4757000042	RL3523DA-9	3523 002 009 9	111	FL6	HB1142	RL3526QL02	3526 030 002 0	100
276101	4640060002	RL2908AA-9	2908 001 001 0-9	169	FL6	AE4427	RL3515LF-D	3515 007 042 0	46
276196	186534	RL2908CA-9	2908 003 001 0-9	169	FL7	0481009047000	RL3531GA10	3531 010 010 0	60
2R0100759H	K001330	RL3509AN-D	3509 014 005 0	2	MAK4000	57977000	RL2908LA06	2908 009 006 0	167
3038069	SV1295	RL2908CA	2908 003 001 0	164		03342-56000	RL3516DA	3516 004 001 0	116
3090239	KW1223.6	3509 051 005 9	3509 051 005 9	13		1189392000	RL3512GA	3512 002 001 0	22
3090257	KW3127.1	3509 051 001 8	3509 051 001 8	13		263243700155	RL3515XA02	3515 018 002 0	54
3090472		3509 051 002 1	3509 051 002 1	13		280915000	RL3512GA-9	3512 002 101 9	25
3090473	KZ126.1SP	3509 051 003 1	3509 051 003 1	13		280915	RL3512GB-9	3512 002 102 9	25
3094804	4324310022	RL3511FA-9	3511 009 101 9	45		280915	RL3512GG-9	3512 002 103 9	25
3127660	4722500000	RL3754PT02	3754 100 002 0	240		40010140	273092833468M	273092833468M	323
3173151	9730090020	RL3522FB-C	3522 004 004 0	123		40010142	273091033468M	273091033468M	323
3173152	9735000470	RL3516BX	3516 002 018 0	115		40010143	273091033478M	273091033478M	323
3181315	4757210010	RL3523GC	3523 013 001 0	110		40010154M1D	273092833478M	273092833478M	323
3192255	3192255	RLD5-Z112	1705 508 001 0	200		40010155	274091033468M	274091033468M	323
3197588	AE4604	RL3515XA01	3515 018 001 0	53		40020238M1D	475091030118	475091030118	293
345209	4341001230	RL3531WA06	3531 013 004 0	62		4324130010	RL3511ES	3511 008 003 0	36
350471	4528020000	RL3521CC	3521 006 002 0	207		4324130020	RL3511ES-A	3511 008 004 0	36
351565	4520021070	RL3520AA	3520 001 001 0	203		4324200030	RL3511AZ-B	3511 003 038 0	29

INDEX BY VEHICLE APPLICATIONS



ZF

OEM No.	Cross Ref.	SORL No.	SORL EU No	Page					
0501 208 630		RL1705QA01	1705 058 001 0	225					
0501 215 359		RL1705QA05	1705 058 005 0	225					
0501 310 059		RL1705QA03	1705 058 003 0	226					
0501 316 521	4630850000	RL1705AA01	1705 015 001 0	198					
	72203	203011930507	203011930507	298					
	72204	204011930507	204011930507	298					
	72326	256011930507	256011930507	316					
	72688	997011931007	997011931007	307					
	72689	998011931007	998011931007	307					
	72854	946011930077	946011930077	327					
	72855	945011930077	945011930077	327					
	72872	994011931037	994011931037	306					
	72929	351061931427	351061931427	294					
	72930	261011931205	261011931205	328					
	79429	203011930507	203011930507	298					
	79430	204011930507	204011930507	298					
	79462	351061931427	351061931427	294					
	79637	931011930507	931011930507	298					
	79638	932011930507	932011930507	298					

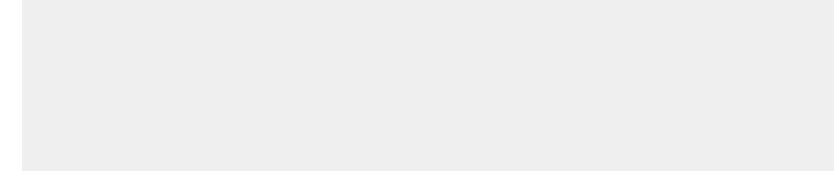



Air Supply 1	
Compressor (Single Cylinder)	1.01
Compressor (Twin Cylinders)	1.02
Electric Air Compressor	1.03
Alcohol Evaporator	1.04
Condenser	1.05
Unloader Valve	1.06
Pressure Protection Valve	1.07
Governor	1.08
Air Processing Unit	1.09
Air Dryer (Twin Cannisters)	1.10
Air Dryer (Single Cannister)	1.11
Air Dryer Base	1.12
Air Dryer Cartridge	1.13
Silencer	1.14
Air Dryer Heater Element	1.15
Anti-Freezer Pump	1.16

Compressor (Single Cylinder) 1.01	
	<p>RL3509AA</p> <p>Working Volume: 229cm³ Air Cooling, Max Speed: 2800 RPM Stroke 36mm</p> <p>Cross Ref. 4110345010</p> <p>Application DAF 1517931 Mercedes 0011315201</p> <p>Repair Kits RL3509AA-9</p>
	<p>RL3509AD</p> <p>Working Volume: 115cm³ Air Cooling, Max Speed: 2800 RPM Stroke 26mm</p> <p>Cross Ref. LK1314</p> <p>Application Iveco 1261822 1261731</p> <p>Repair Kits RL3509AD-9</p>
	<p>RL3509AD-A</p> <p>Working Volume: 154cm³ Air Cooling, Max Speed: 3000 RPM Stroke 35mm</p> <p>Cross Ref. I88770R</p> <p>Application Mercedes A0031314801</p> <p>Repair Kits RL3509AD-A-9</p>

	<p>RL3509AE</p> <p>Working Volume: 292cm³ Air Cooling, Max Speed: 3000 RPM Stroke 46mm</p> <p>Application Mercedes 4701300115 MAN 51540007058</p> <p>Repair Kits RL3509AE-9</p>
	<p>RL3509AE-A</p> <p>Working Volume: 292cm³ Air Cooling, Max Speed: 3000 RPM Stroke 46mm</p> <p>Application MAN 51540007074 Mercedes 4701301515</p> <p>Repair Kits RL3509AE-9</p>
	<p>RL3509AN</p> <p>Working Volume: 225cm³ Water Cooling, Max Speed: 3000 RPM Stroke 37mm</p> <p>Cross Ref. I90265</p> <p>Application VW TAC145605</p>
	<p>RL3509AN-A</p> <p>Working Volume: 225cm³ Water Cooling, Max Speed: 3000 RPM Stroke 37mm</p> <p>Cross Ref. II15126</p> <p>Application VW 2RP145605</p> <p>Repair Kits RL3509AN-9</p>

Compressor (Single Cylinder) 1.01	
	<p>RL3509AN-B</p> <p>Working Volume: 225cm³ Water Cooling, Max Speed: 3000 RPM Stroke 37mm</p> <p>Cross Ref. II31343 Application VW 2VC145605 Repair Kits RL3509AN-9</p>
	<p>RL3509CA02</p> <p>Working Volume: 293cm³ Water Cooling, Max Speed: 3000 RPM Stroke 46mm</p> <p>Cross Ref. 3509010-671-0382 Application FAW CA6DL</p>
	<p>RL3509AN-D</p> <p>Working Volume: 225cm³ Water Cooling, Max Speed: 3000 RPM Stroke 37mm</p> <p>Cross Ref. K001330 Application VW 2R0100759H Volvo 20742000 Repair Kits RL3509AN-9</p>
	<p>RL3509AZ-E</p> <p>Working Volume: 292cm³ Water Cooling, Max Speed: 3000 RPM Stroke 46mm</p> <p>Cross Ref. 4751300115R Application Mercedes A4271300515 A4751300115R Repair Kits RL3509AZ-E-9</p>

	<p>RL3509AB01</p> <p>Working Volume: 293cm³ Water Cooling, Max Speed: 3000 RPM Stroke 46mm</p> <p>Cross Ref. 3509010-B4000 Application Yutong Bus B4000 Kinglong</p>
	<p>RL3509DJ-D</p> <p>Working Volume: 293cm³ Water Cooling, Max Speed: 3000 RPM Stroke 46mm</p> <p>Cross Ref. 612600130307 Application Caiwei WP10</p>
	<p>RL3509DJ-E</p> <p>Working Volume: 168cm³ Water Cooling, Max Speed: 3000 RPM Stroke 38mm</p> <p>Cross Ref. 612600130496 Application Caiwei WP6</p>
	<p>RL3509BX</p> <p>Working Volume: 225cm³ Water Cooling, Max Speed: 3000 RPM Stroke 37mm</p> <p>Cross Ref. 8845034370 Application Mercedes A9061300615 Repair Kits RL3509BX-9</p>

Compressor (Single Cylinder) 1.01	
	<p>RL3509CC</p> <p>Working Volume: 225cm³ Water Cooling, Max Speed: 3000 RPM Stroke 37mm</p> <p>Cross Ref. I136928R, 4111510060</p> <p>Application Mercedes A3761310101 A3761317401</p> <p>Repair Kits RL3509CC-9</p>
	<p>RL3509CD</p> <p>Working Volume: 225cm³ Water Cooling, Max Speed: 3000 RPM Stroke 37mm</p> <p>Cross Ref. I115140, 4110345310</p> <p>Application Mercedes A0021313701 A0021311501</p>
	<p>RL3509CE</p> <p>Working Volume: 225cm³ Water Cooling, Max Speed: 3000 RPM Stroke 37mm</p> <p>Cross Ref. I136928AGR</p> <p>Application Mercedes</p>
	<p>RL3509CH</p> <p>Working Volume: 225cm³ Water Cooling, Max Speed: 3000 RPM Stroke 37mm</p> <p>Cross Ref. 8845035860, 9111550500</p> <p>Application VW 2T0100759</p>

	<p>RL3509DH-B</p> <p>Working Volume: 318cm³ Water Cooling, Max Speed: 3000 RPM Stroke 56mm</p> <p>Cross Ref. 9111530010</p> <p>Application Mercedes 4571300515</p> <p>Repair Kits RL3509AZ-E-9</p>
	<p>RL3509DH-C</p> <p>Working Volume: 352cm³ Water Cooling, Max Speed: 3000 RPM Stroke 62mm</p> <p>Cross Ref. 4123520260</p> <p>Application Mercedes 4571304415</p>
	<p>RL3509DJ</p> <p>Working Volume: 359cm³ Water Cooling, Max Speed: 3000 RPM Stroke 54mm</p> <p>Cross Ref. K001119V</p> <p>Application Scania 1678516</p>

Compressor (Twin Cylinders) 1.02	
	<p>RL3509BX-A</p> <p>Working Volume: 292cm³ Water Cooling, Max Speed: 3000 RPM Stroke 38.1mm</p> <p>Cross Ref. EL13151</p> <p>Application Caterpillar</p>
	<p>RL3509BC</p> <p>Working Volume: 636cm³ Water Cooling, Max Speed: 3000 RPM Stroke 56mm</p> <p>Cross Ref. 9115530020</p> <p>Application Mercedes 4571301815</p>

Compressor (Twin Cylinders) 1.02	
 <p>RL3509BE Working Volume: 442cm³ Water Cooling, Max Speed: 3000 RPM Stroke 50mm</p> <p>Cross Ref. KZ433.1, KZ642.1 Application Volvo 8112781 Scania 571181</p>	
 <p>RL3509BJ Working Volume: 440cm³ Water Cooling, Max Speed: 2800 RPM Stroke 50mm</p> <p>Cross Ref. 9115040520 Application DAF 762788</p>	
 <p>RL3509BH Working Volume: 600cm³ Water Cooling, Max Speed: 3000 RPM Stroke 56mm</p> <p>Cross Ref. ACX83D Application Iveco 500310903 500314094</p>	
 <p>RL3509BZ-H Working Volume: 636cm³ Water Cooling, Max Speed: 1250 RPM Stroke 56mm</p> <p>Cross Ref. VG1560130080 Application SINO Truck</p>	

 <p>RL3509DH Working Volume: 440cm³ Water Cooling, Max Speed: 3000 RPM Stroke 50mm</p> <p>Cross Ref. I135564, LP4850 Application Volvo 8119270 8129779 8113270</p>	
 <p>RL3509DH-A Working Volume: 608cm³ Water Cooling, Max Speed: 3000 RPM Stroke 50mm</p> <p>Cross Ref. LK4941 Application Scania 1796663</p>	
 <p>RL3509DH-D Working Volume: 363cm³ Water Cooling, Max Speed: 3000 RPM Stroke 47.5mm</p> <p>Cross Ref. RCCS00031 Application Scania 1678516</p>	
 <p>RL3509DH-E Working Volume: 636cm³ Water Cooling, Max Speed: 3000 RPM Stroke 56mm</p> <p>Cross Ref. 9125101040 Application Mercedes 4571304915</p>	

Compressor (Twin Cylinders) 1.02	
RL3509DJ-A	
	Working Volume: 627cm ³ Water Cooling, Max Speed: 3000 RPM Stroke 54mm
	Cross Ref. LK4936 Application Iveco 42534245 Repair Kits RL3509CC-9

Electric Air Compressor 1.03	
RL3509EA	
	Working Volume: 440cm ³ Air Cooling, Max Speed: 1420 RPM Stroke 50mm, DC: (220-380)V
	Application FAW, More Than 10m Vehicle
RL3509EB	
	Working Volume:32L/Min DC: 24V, Air Cooling Max working pressure: 0.7MPa
	Cross Ref. SPWOED 3224 Application Bus













Repair Kits	Kits P/N	Repair Kits For	Cross Ref.	Application	
	RL3509AA-9	 RL3509AA	Similar With LK1303 LK1304 LK1314 LK1527		
	3509 001 002 1				
	3509 001 001 1				
	3509 001 002 8				
	3509 001 006 1		411 042 660 4	Mercedes 0001311132	
	3509 001 005 1		411 042 690 4	Mercedes 0001313716	
	3509 001 001 8				
	3509 001 003 8		411 042 620 2	Mercedes 0001301117	
	RL3509AD-9		 RL3509AD		
	3509 004 002 1				
	3509 004 002 8				
	3509 004 008 1				
	3509 004 005 1				
	3509 004 003 8				
	3509 004 001 1				

Repair Kits	Kits P/N	Repair Kits For	Cross Ref.	Application
	RL3509AD-A-9	 RL3509AD-A	Similar With LK1300 LK1511	
	3509 004 004 9			
	3509 004 005 9			
	3509 004 023 1			
	3509 004 005 1			
	3509 004 008 9			
	3509 004 002 8			
	3509 004 006 9			
	3509 004 002 1			
	3509 004 007 9			
	3509 004 009 9			
	RL3509AE-9	 RL3509AE		
	3509 054 001 1		4471310215, 407130 0610 51541126003	MAN Mercedes
	3509 054 010 8		4031312002	MAN Mercedes
	3509 054 002 8		402130 0120, 402130 0320	MAN Mercedes
	3509 054 011 8		4031300645, 4031301045	MAN, Mercedes
	3509 054 015 1		4031311016 4031310716	MAN Mercedes
	3509 054 001 8		403132216, 4031302816 51541066013	MAN Mercedes
	3509 054 003 8		4421300008	MAN Mercedes
	3509 054 004 8			MAN 81541110026 Mercedes 411033653.2
	3509 054 008 8			WSK.97.A
	3509 054 009 8		 RL3509AE-A	WSK.97.W





















Repair Kits	Kits P/N	Repair Kits For	Cross Ref.	Application	
	RL3509AZ-E-9	 RL3509AZ-E		Mercedes Actros	
	3509 055 003 1		4071300519 4071300219		
	3509 054 015 1		51541135017, 51541135027 4031310216, 4031310716		
	3509 054 001 8		4031302816 51541066013		
	3509 055 005 9		4421300008 51541606006		
	3509 055 002 8				
	3509 055 003 9				
	3509 055 004 9		4031301645 51541306011		
	3509 054 003 8		RK0102210, RK0102220 RK 0102230, RK0102240		
	3509 055 006 9				
	RL3509AN-9		 RL3509AN-A	RL3509AN-A RL3509AN-B RL3509AN-D	
	3509 014 006 1				
	3509 014 004 9				
	3509 004 005 1				
	3509 014 006 9				
	3509 014 007 9				
	3509 014 003 9				
	3509 014 005 9				
	3509 014 024 1				
	3509 005 005 9				
	3509 014 008 9				

Repair Kits	Kits P/N	Repair Kits For	Cross Ref.	Application	
	RL3509BX-9	 RL3509BX	Similar With 4111530002		
	3509 056 003 1			Mercedes 0001312121	
	3509 056 003 9				
	3509 056 001 9			Similar With 4111530022	
 CC	3509 003 004 8				
	3509 056 002 9			4111516522	Mercedes 0001310809 0001310909
	3509 003 008 1			4111476034	Mercedes 0001312932
	3509 056 006 1				
	3509 003 005 8			9111457372	Mercedes 0001312419 0001312417,0001312517
	3509 056 002 1				
	RL3509CC-9		 RL3509CC		
	3509 005 003 9				
	3509 005 005 9				
	3509 004 005 1				
	3509 005 009 9				
	3509 004 025 1				
	3509 005 004 9				
	3509 005 006 9				
	3509 005 025 1				

Repair Kits	Kits P/N	Repair Kits For	Cross Ref.	Application
	RL3509CH-9	 RL3509CH		
	3509 029 002 1			
	3509 003 003 9			
 CG	3509 003 004 8			
	3509 003 004 9			
	3509 029 002 9			
	3509 029 003 9			
	3509 029 001 8			
	3509 029 005 4			
	3509 029 003 1			
	RL3509DH-B-9	 RL3509DH-B		
	3509 032 003 1			
	3509 003 003 9			
 CG	3509 003 004 8			
	3509 003 004 9			
	3509 056 002 9			
	3509 003 008 1			
	3509 032 004 1			
	3509 029 001 8			
	3509 032 002 1			

Repair Kits	Kits P/N	Repair Kits For	Cross Ref.	Application	
	RL3509DH-C-9	 RL3509DH-C		Mercedes 0001305019	
	3509 033 002 1			Mercedes 0009982790	
	3509 033 002 9			4123529222	Mercedes 0011302615 0001301215 0011305219
	3509 033 004 9				
	3509 003 004 9			9115016242	Mercedes 0001305317
	3509 033 006 1				
	3509 033 003 9				
	3509 033 005 9				
	3509 033 001 8			9111457382	Mercedes 0001312517
	3509 033 004 1				Mercedes 0001317616 0001317516
	RL3509DJ-9	 RL3509DJ			
	3509 036 002 1				
	3509 036 005 8				
	3509 036 003 9				
	3509 036 003 1				
	3509 036 004 9				
	3509 036 002 9				
	3509 036 004 1				
	3509 036 002 8				
	3509 030 012 1				

Repair Kits	Kits P/N	Repair Kits For	Cross Ref.	Application
	RL3509BX-A-9	 RL3509BX-A		
	3509 057 003 1			
	3509 057 004 1			
	3509 057 002 8			
	3509 057 002 9			
	3509 057 003 8			
	3509 057 001 8			
	3509 057 002 1			
	3509 003 005 9		 RL3509BC	
	3509 003 007 1			
	3509 003 005 8			
	3509 003 004 9			
	3509 003 008 1			

Repair Kits	Kits P/N	Repair Kits For	Cross Ref.	Application	
	RL3509BE-9	 RL3509BE	KW 3974.1		
	3509 051 002 1		Volvo 3090472 Scania 1518374		
	3509 051 003 1		Volvo 3090473 Scania 1518372		
	3509 051 004 9				
	3509 051 005 1		KY 1564.1	Scania 1518353	
	3509 051 003 9				
	3509 051 001 8		KW 3127.1	Scania 1518356, 1322814 Volvo 3090257	
	3509 051 005 9		KW 1223.6	Scania 1518349, 16962001 Volvo 3090239	
	RL3509BH-9		 RL3509BH	K01920	Iveco 93162116 93161842
	3509 028 004 1				
	3509 028 002 9				
	3509 028 004 9				
	3509 028 005 1	II159920065		Iveco 1376275 1376285	
	3509 028 005 9				
	3509 028 003 9				
	3509 028 001 8	SEB 00967004		Iveco 3097151	
	3509 028 012 1				
	3509 028 002 1			Iveco 1137760	

Repair Kits	Kits P/N	Repair Kits For	Cross Ref.	Application
	RL3509DH-9			
	3509 030 002 9			
	3509 030 004 9			
	3509 030 003 8			
	3509 030 005 9			
	3509 030 002 1			
	3509 030 003 9			
	3509 030 003 1			
	3509 030 004 1			
	3509 030 012 1			
	RL3509DH-A-9			
	3509 031 002 1		SEB 01444004	Scania 1424766
	3509 031 002 9		SEB 01033004	Scania 1376272
	3509 031 004 9			
	3509 031 005 9			
	3509 031 002 8		SEB 00967004	Scania 3097151
	3509 031 003 9			
	3509 005 005 9			Mercedes 0001319311 Scania 1698848
	3509 031 004 1		SEB 017531	
	3509 031 003 1		1932013	



Repair Kits	Kits P/N	Repair Kits For	Cross Ref.	Application
	RL3509DH-D-9	 RL3509DH-D		
	3509 034 004 1			
	3509 034 002 9			
	3509 034 002 1			
	3509 057 002 9			
	3509 057 003 8			
	3509 057 001 8			
	3509 034 003 1			
	RL3509DH-E-9	 RL3509DH-E		
	3509 035 002 1			
	3509 035 002 9			
	3509 035 003 9			
	3509 003 005 8			
	3509 003 004 9			
	3509 003 008 1			
	3509 035 004 9			
	3509 033 006 1			
	3509 035 004 1			

Repair Kits	Kits P/N	Repair Kits For	Cross Ref.	Application
	RL3509DJ-A-9	 RL3509DJ-A		
	3509 037 002 1			
	3509 037 002 9			
	3509 037 003 9			
	3509 037 012 1			
	3509 037 005 8			
	3509 037 004 9			
	3509 037 002 8			
	3509 037 003 1			
	3509 037 004 1			

Alcohol Evaporator		1.04	
		RL3529CA	
		Ports 1, 2: M14X1.5 Application: Trailer	
Application	Trailer		
		RL3529DA	
		Ports 1, 2: NPT 1/2	
Cross Ref.	A72420		
Application	Trailer		
		RL3529EA	
		Ports 1, 2: M14x1.5	
Cross Ref.	23500-1010		
Application	HINO		





Condenser		1.05	
		RL3529TA01	
		Thread Connection: M22x1.5 Voltage/Current : 24v / 0.5a Electrical Connection: M27x1 Max Operating Pressure: 20bar	
Cross Ref.	71369		
Application	Mercedes	0044321501	





		RL3529TA17	
		Thread Connection: NPT1/2 Voltage/Current: 24V/0.5A Electrical Connection: M27x1	
		Cross Ref.	35TAA-50030 41210029
Application	SuZhou King Long	Volvo	20745320
		Scania	1457303
		Iveco	42021334 01299031





Unloader Valve		1.06	
		RL3512AA	
		Port 1,21: M22x1.5 Port 1-2: M16x1.5 Cut-out Pressure: 8.1	
		RL3512AB	
		Cut-out Pressure: 8.1bar Ports: 1+21=M22x1.5, 1-2=M16x1.5	
Cross Ref.	9753001100		
Alternative	DR3200		
Application	Iveco	2516892	
	Mercedes	0014310006	
Repair Kits	RL3512AB-9		

		RL3512AC	
		Ports: 1+21=M22x1.5 Cut-out Pressure: 8.1bar Comment: No Tyre Inflator	
		Cross Ref.	9753000140
Alternative	DR3206 312016014		
Application	DAF	100587, 658098	
	Mercedes	0024313006	

Unloader Valve		1.06
	RL3512AD	
	Port 1,21: M22x1.5 Port 1-2: M16x1.5 Cut-out Pressure: 8.1bar ΔP : (0.6-1.3)bar Open-out Pressure: 9.3bar	
	RL3512AH	
	Port 1,21:M22x1.5 Port 1-2: M16x1.5 Cut-out Pressure: 6.9bar Open-out Pressure: 8.1bar	
	RL3512PA06	
	Port1: M22x1.5, Port21: M22x1.5 Port 1-2: M16x1.5 Cut Out Pressure: 8.1bar	
Cross Ref. Application	DR3200 MAN 81521016253	
	RL3512PA08	
	Ports 1,21: M22x1.5 Port 1-2: M16x1.5 Cut-off pressure: 8.5bar	
	RL3512BA-C	
	Inlet Port 1: M18X1.5-6g Outlet Port 21: M18x1.5-6g Cut-off Pressure (8.1 ± 0.2)bar	
Cross Ref. Application	13042356M0187 Foton Rowor I	

	RL3512BC	
	Port 1: M22x1.5, Port 21: M22x1.5 Port 23: M12x1.5, Port 4: M12x1.5 Port 1-2: M16x1.5 Cut-out Pressure: 8.1bar	
Cross Ref. Application	3512N-010-B Dong Feng	
	RL3512BG	
	Ports: 1, 21=M22x1.5 Port 1-2: M16x1.5 Cut-out Pressure: 8.1bar	
Cross Ref. Alternative Application	9753034640 DR3100 312013014 Iveco 2516892 Mercedes 0014310006	
	RL3512BK	
	Ports: 1,21=M22x1.5, 23,4=M12x1.5 Cut-out Pressure: 8.1bar	
Cross Ref. Alternative Application	9753034740 DR3502 312030001 Mercedes 0024311506 DAF 285768	
	RL3512BJ	
	Ports: 1,21=M22x1.5 Cut-out Pressure: 8.1bar	
Cross Ref. Alternative Application	9753034730 DR3200 312013014 Iveco 2516892 Mercedes 0014310006	
	RL3512BJ-A	
	Port 1,21: M22x1.5 Port 22: M12x1.5 Cut-out Pressure: 9.5	



Unloader Valve		1.06
		RL3512NA
		Ports: 1,21=M22x1.5, 22=M12x1.5 Port 1-2: M16x1.5 Cut-out Pressure: 8.1bar
Cross Ref.	0481039221000	
Alternative	975300110	
Application	DAF	1505157
	Iveco	02516892
	MAN	81521016076
	Mercedes	0014310006
		RL3512BG01
		Cut-out Pressure:8.5bar Port 1: M22x1.5, Port 21: M22x1.5 Port 22: M12x1.5, Port 23: M12x1.5 Port 4: M12x1.5
Cross Ref.	9753030710	
Application	DAF	1518280
	Mercedes	0034314806
		RL3512BG02
		Port 1: M22x1.5 , Port 21: M22x1.5 Cut-out Pressure:9.5 bar Tyre Inflation 1-2: With Plug
Cross Ref.	9753030800	
Alternative	DR3100	
Application	DAF	1518281
	Iveco	04700994
	Mercedes	0014312206
		RL3512BG03
		Port 1: M22x1.5 Port 21: M22x1.5 Port 22: M12x1.5 Cut-out Pressure: 8.1bar Tyre Inflation 1-2: With Plug
Cross Ref.	9753030600	
Alternative	DR3206	
Application	DAF	0658098
	Neoplan	1102441544303
	Volvo	6778243

		RL3512BG04
		Port 1: M22x1.5 , Port 21: M22x1.5 Port 22: M12x1.5 , Port 23: M12x1.5 Port 4: M12x1.5 Cut-out Pressure: 10 bar Tyre Inflation 1-2: Available
Cross Ref.	9753035040	
Application	DAF	1518287
	MAN	81521016191
	Mercedes	0024311606
	RVI	5010019862
		RL3512BG05
		Port 1: M22x1.5, Port 21: M22x1.5 Port 22: M12x1.5, Port 23: M12x1.5 Port 4: M12x1.5 Cut-out Pressure: 8.5 bar Tyre Inflation 1-2: Available
Cross Ref.	9753034720	
Alternative	DR3531	
Application	Mercedes	0020317106
		RL3512BG06
		Port 1: M22x1.5 Port 21: M22x1.5 Port 22: M12x1.5 Cut-out Pressure: 10 bar Tyre Inflation 1-2: Available
Cross Ref.	9753035030	
Alternative	312017041	
Application	DAF	1518286
	MAN	81521016097
	Mercedes	0014316106
		RL3512BG07
		Port 1: M22x1.5 Port 21: M22x1.5 Port 22: M12x1.5 Cut-out Pressure: 9.5 bar Tyre Inflation 1-2: Available
Cross Ref.	9753034800	
Alternative	DR3208	
	312013031	
Application	DAF	1505480
	Iveco	02517784





Unloader Valve		1.06
RL3512BG08		
	Port 1: M22x1.5 Port 21: M22x1.5 Port 22: M12x1.5 Cut-out Pressure: 8.5 bar Tyre Inflation 1-2: Available	
Cross Ref.	9753031690	
Application	DAF, MAN	
RL3512BG29		
	Ports 1,21: M22x1.5 Port 22: M12x1.5 Cut-off pressure: 7.3bar	
Cross Ref.	9753034470	
Alternative	DR 3100 312013002	
Application	Mercedes	0014312206
RL3512BH		
	Ports: 1+21=M22x1.5, 4+23=M12x1.5 Cut-out Press: 9.5 bar Comment: No Tyre Inf.or Check	
Cross Ref.	9753030850	
Application	Iveco	61259232
	Mercedes	0024316606
RL3512BU		
	Inlet Port: M22x1.5-6h Outlet Port 21: M22x1.5-6h Port 1-2: M16x1.5 Cut-off Pressure (8.1± 0.2)bar	
Cross Ref.	1104335600149	
Application	Foton Ollin	



RL3512CB		
	Ports: 1, 21=M22x1.5 Port 1-2: M16x1.5 Cut-out Pressure: 8.1bar	
Cross Ref.	DR3500	
Application	Mercedes	A0024318306 0481039201000
Repair Kits	RL3512CB-9	
RL3512CB02		
	Ports 1,2-1: M22x1.5 Port 23: M12x1.5 Cut-off pressure: 10.5bar	
Cross Ref.	II38201	
Application	Ford, VW	
RL3512FA		
	Cut-out Pressure: 8.1bar Port 1: M10x1 Port 2: M10x1	
Application	FAW CA151	

Unloader Valve For R-7		1.06
RL3512PA05		
	Supply: 3/8"NPT Delivery: 3/8"NPT Control: 1/4"NPT Balance: 1/4"NPT Spring Brake Release Pressure: 95psi	
Cross Ref.	103081	

Pressure Protection Valve For PR-2 1.07	
	<p>RL3512PA01</p> <p>Supply: 1/4"PT, Delivery: 1/4"PT Opening Pressure: 78psi Nominal Closing Pressure: 65psi</p> <p>Cross Ref. 277147 Application Trailer</p>
	<p>RL3512PA03</p> <p>Supply: 1/4"NPT, Delivery: 1/4"NPT Opening Pressure: 78psi Nominal Closing Pressure: 65psi</p> <p>Cross Ref. 277147 Application Trailer</p>
	<p>RL3512PA07</p> <p>Inlet Port1: NPT1/4 Outlet Port2: NPT1/4 Open Pressure: 84psi Close Pressure : > 72psi</p> <p>Cross Ref. 277148 Application Trailer</p>



Pressure Protection Valve For RV-1 1.07	
	<p>RL3512PA02</p> <p>Supply: 1/4"PT, Delivery: 1/4"PT Limiting pressure: 5bar</p> <p>Cross Ref. 283590 Application Trailer</p>

	<p>RL3512PA04</p> <p>Supply: 1/4"NPT Delivery: 1/4"NPT Limiting pressure: 5bar</p> <p>Cross Ref. 283590 Application Trailer</p>
	<p>RL3512PA-A</p> <p>All Ports thread: NPT1/4 Opening pressure: (400-420)kPa Closing pressure: > 310 kPa</p> <p>Cross Ref. 277226N Application Truck</p>
	<p>RL3512PA-B</p> <p>All Ports thread: NPT1/4 Limiting pressure: (580-600)kPa</p> <p>Cross Ref. 101135N Application Truck</p>
	<p>RL3512PA-C</p> <p>All Ports thread: NPT1/4 Limiting pressure: (270-290)kPa</p> <p>Cross Ref. 279926N Application Truck</p>
	<p>RL3512PA-D</p> <p>All Ports thread: NPT1/4 Opening pressure: (500-520)kPa Closing pressure: > 410 kPa</p> <p>Cross Ref. 277227N Application Truck</p>

Governor		1.08
RL3512GA-C		
 <p>Cut Out Pressure: 8.7bar Ports: All 1/8"NPT</p>		
RL3512GA		
 <p>Cut-out Pressure: 6.7bar Open Pressure: 7.8bar Ports: All 1/8" NPT</p>		
Cross Ref. Application	1189392000 Volvo	
RL3512GB		
<p>Cut-out Pressure: 7.8bar Ports: All M10x1</p>		
Cross Ref. Application	1189393000 Volvo	
RL3512GC		
<p>Cut-out Pressure: 7.8bar Ports: 7xM10</p>		
RL3512GE		
<p>Cut-out Pressure :7.8bar Port Res: Rc1/8 Port Unl: Rc1/4</p>		







RL3512GG	
<p>Ports: Del 1/4" RP All Others 1/8" NPT Cut-out Pressure: 7.9bar</p>	
Repair Kits	RL3512GA-9 RL3512GB-9 RL3512GG-9
RL3512GA-D	
 <p>Ports: 7xM10x1 Open Pressure: (0.79 ± 0.02)Mpa Cut-out Pressure: (0.67 ± 0.02)Mpa</p>	
RL3512GA-F	
 <p>Ports: 7xM10x1 Opening Pressure: 12.5bar Cut-out Pressure: 11.3bar</p>	
RL3512GA-G	
 <p>Ports: 7xNPT1/8 Opening Pressure: 8.6bar Cut-out Pressure: 7.2bar</p>	
RL3512GB42	
 <p>All Ports thread M10x1 Installation hole: Φ8.8 Output opening pressure: 8.5bar</p>	
RL3512GB44	
 <p>All Ports thread M10x1 Installation hole: Φ8.8 Output Opening Pressure: 9bar</p>	

Governor		1.08
	RL3512GA-I	
	Ports: 3xNPT1/8 Opening Pressure: 8.2bar Cut-out Pressure: 6.8bar	
	RL3512GL-A	
	Ports: 7xNPT1/8 Opening Pressure: 8.4bar Cut-out Pressure: 7.1bar	
	RL3512GL-B	
	Ports: 7xNPT1/8 Opening Pressure: 8.4bar Cut-out Pressure: 7.1bar	
	RL3512GL-M	
	Ports: 7xM10x1 Opening Pressure: 12bar Cut-out Pressure: 9.5bar	
	RL3512GM	
	Ports: Res=1/8"NPT UNL=1/8"NPT Opening Pressure: 8.0bar	
Application	Nissan	47540-Z0005
	RL3512GN	
	Ports: RES=1/8" NPT UNL=1/4" NPT Opening Pressure: 8.2bar	
Application	Mitsubishi	MC808718
Repair Kits	RL3512GM-9 RL3512GN-9	





	RL3512GP	
	Ports: RES.EXH=1/8" NPT UNL=1/4" NPT Cut-out Pressure: 8.4bar	
Application	Mitsubishi	MC826122
Repair Kits	RL3512GP-9	
	RL3512JA	
	Port: RC1/4 Cut-out Pressure: (7.8-8.8)bar (8.0-9.0 Kgf/Cm ²)	
Application	Hino	44530-1330
	RL3512GL	
	Ports: ALL 1/8"NPT Opening Pressure: 8.6bar	
Cross Ref.	284358	
Application	Scania	1308511
	RL3512GL-C	
	Ports: ALL 1/8"NPT Opening Pressure: 8.3bar	
Cross Ref.	275491, 282436	
Application	Volvo	160788, 1505047, 3944250 1193532, 70101, 3404
	Scania	293546, 333851
	RL3512GL-D	
	Ports: ALL 1/8"NPT Opening Pressure: 9.3bar	
Cross Ref.	283657	
Application	Komatsu, VW	5504 Model 325M, 85D

D2 Governor		1.08	
		RL3512GL-E	
		Opening Pressure: 9bar Ports: ALL 1/8"NPT	
Cross Ref.	277486		
Application	Truck		
		RL3512GL-F	
		Opening Pressure: 8.6bar Ports: ALL 1/8"NPT	
Cross Ref.	275707		
Application	Truck		
		RL3512GL-G	
		Opening Pressure: 8.6bar Ports: ALL 1/8"NPT	
Cross Ref.	275530		
Application	Truck		
		RL3512GL-H	
		Opening Pressure: 7.6bar Ports: ALL 1/8"NPT	
Cross Ref.	275508		
Application	Volvo	1503492	
		RL3512GL-K	
		Opening Pressure: 7.2bar Ports: ALL 1/8"NPT	
Cross Ref.	275200		
Application	Truck		

		RL3512LA	
		Cut Out: 7.8 bar Port: M20x1.5	
Application	ISUZU	1-48350-059-0	
		RL3512LA-A	
		Cut-out: 8.3 bar Port: M20x1.5	
Cross Ref.			
Application	ISUZU	1-48350-058-0	

Repair Kits	Kits P/N	Repair Kits For	Cross Ref.	Application
	RL3512AB-9	RL3512AB	975300002	DAF 1519340 Iveco 02980732 MAN 81521016118 Mercedes 0004301107
	RL3512BG-9 RL3512BJ-9 RL3512BK-9	RL3512BG RL3512BJ RL3512BK	9753030012	DAF 0698276 Iveco 08124505 MAN 82521016019 Mercedes 0014304960
	RL3512CB-9	RL3512CB	187546	Mercedes
	RL3512GA-9 RL3512GB-9 RL3512GG-9	RL3512GA RL3512GB RL3512GG	280915	Volvo, Scania
	RL3512GM-9 RL3512GN-9	RL3512GM RL3512GN		
	RL3512GL-9	RL3512GL	Similar with 276121	
	RL3512GP-9	RL3512GP		

Air Processing Unit		1.09
RL3511XA01		
	Port1: M22x1.5 Ports 21,22,23,24: M16x1.5 Installation Plate Hole: M12x1.5 Protection Opening Pressure 21, 22: 0bar, 23, 24:6.3bar Cut-off Pressure: 8.0bar	
Cross Ref.	M305201	
Application	Universal	
RL3511XA02		
	All Ports: M22x1.5 Installation hole thread: 2xM12x1.5-6H Cut-off pressure: (830±20)kPa	
Cross Ref.	100304941, M304941	
Application	Universal	
RL3511XB01		
	Ports: M22x1.5-6H, M16x1.5-6H Working Voltage: 5V Cut-off pressure: (1050 ± 20)kPa	
Cross Ref.	ZB4805	
Application	Mercedes	
RL3511XB04		
	Ports 12,24 thread: M22x1.5 Port 23 thread: M16x1.5 Installation hole thread: 3xM12x1.5 Cut-off pressure: (1050 ± 20)kPa Comment: ZB4587=LA8125+AE4502 35110270010= 35110270020+35150230030	
Cross Ref.	ZB4587	
Application	Iveco	41211254 41211384 41285078



RL3511EK-E	
	Outlet Port 21,22,23,24: M16x1.5-6H Inlet Port: M18x1.5-6H Working Voltage: 24V Cut-off Pressure: 8.1 ± 0.2bar
Cross Ref.	13062356M0205
Application	Rowor III -140,Rowor III -190 Mercedes 6934207871
RL3511EQ78	
	Port1: M22x15 Port21,22,23,24: M16x1.5 DC: 24V , Cut-off Pressure: 8.5bar
Cross Ref.	9325000350
Application	FAW, King Long Foton, CNHTC
RL3511EF	
	Ports: 1=M22x1.5, 21+22+23+24=M16x1.5 Heat: 24V Cut-off Pressure: 9.5bar Backflow: (0.3-0.6)bar Protection Opening Pressure: 21+22+24=6.9bar, 23=7.9bar
Application	Foton
RL3511DG	
	Cut-off Pressure: 10.0bar Safety: 14.5 ^{+2.5} ₀ bar
Cross Ref.	9325000030
Application	Mercedes 6934207871
RL3511DG-A	
	Cut-off Pressure: 10.0bar Safety: 14.5 ^{+2.5} ₀ bar
Cross Ref.	9325000040
Application	Mercedes 0004301515



Air Processing Unit		1.09
RL3511DG31		
	Port 11: M22x1.5 Ports 12,27,28: M12x1.5 Port 22: M16x1.5 Voss Ports 4/25: M10x1 Voss Open Pressure Ports 23,24,25,26,27,28: (720-750)kPa Close Pressure: Ports 23,24 > 450kPa	
Cross Ref.	ZB4534 , 9345000140	
Application	Mercedes	0024310715
	DAF	1518170
RL3511DG32		
	Port 11: M22x1.5 Port 12: M12x1.5, Port 22: M16x1.5 Ports 23,24,25,26,27,28 Opening Pressure: (720-750)kPa Close Pressure: Ports 23,24 > 450kPa	
Cross Ref.	9325000070	
Application	Mercedes	0014317915
	DAF	1505230
RL3511DG33		
	Port 11: M22x1.5, Port 12: M12x1.5 Port 22: M16x1.5 Voss Ports 4/25: M10x1 Voss Ports 23,24,25,26,27,28 Open Pressure : (720-750)kPa Close Pressure: Ports 23,24 > 450kPa Comment: Without Heater	
Cross Ref.	9325000130	
Application	Mercedes	0024310615
	DAF	1505498
RL3511DG36		
	Port 11: M22x1.5 Port 22: M16x1.5 Voss Opening Pressure Port 23,24,25,26: (680-720)kPa Close Pressure: Ports 21,22 > 500kPa DC: 24V	



RL3511DJ-A	
	Ports: 11, M22x1.5, 22 M16x1.5, 21, 22, 23, 24, 25, 26: M22x1.5 Open Press 21, 22: 6.0bar Open Press 23, 24, 25, 26: 7.0bar Heat: 24V Cut-off Pressure: 10bar Comment: With Muffler
RL3511DG34	
	Port 11: M22x1.5, Port 12: M12x1.5 Port 22: M16x1.5 Voss Open Pressure Ports 23, 24, 25, 26, 27, 28: (720-750)kPa Close Pressure: Ports 23, 24 > 450kPa Comment: Without Heater
Cross Ref.	9325000060
Application	Mercedes
	0014317815
RL3511DG44	
	Port 11: M22x1.5 Port 22: M16x1.5 Voss Installation hole thread: 2xM12x1.5-6H Cut-off pressure: (1000 ± 20)kPa Comment: Base for 3511 006 007 0 + 3511 017 001 0
RL3511ZB01	
	Working Pressure Range: (0-1.2)MPa Working Temperature: -40°C -+80°C Installation Hole: 84mm, DC: 5V
Cross Ref.	4410435011





Air Dryer (Twin Cannisters)		1.10
RL3511FA		
	Heat: 24V Ports: 1+21=M22x1.5, 4=M16x1.5 Comment: Orifice Bore 0.9mm	
Cross Ref.	4324311910	
Application	Volvo	1082030
Repair Kits	RL3511FA-9	

Air Dryer(Single Cannister) 1.11	
RL3511AM	
	Heat: 24V, Conn.: M27x1 Ports: 1+21=M22, 22=M12 Cut-off Pressure: 8.1bar Comment: Without Muffler
Cross Ref.	4324101020
Application	Iveco 980829 DAF 1505967 MAN 81521026023
RL3511AM-A	
	Heat: 24V, Conn.: M27x1 Ports: 1+21=M22, 22=M12x1.5 Cut-off Pressure: 8.1bar Comment: With Silencer
Cross Ref.	4324101040
Application	Evobus 8285537000
RL3511AM-B	
	Ports: 1+21=M22, 22=M12x1.5 Cut-off Pressure: 12.5bar Comment: Without Muffler
Cross Ref.	4324101110
Application	MAN 81521026020
RL3511AM-E	
	Conn:27x1 Ports 1,21: M22x1.5 Ports 22: M12x1.5 Cut-off Pressure: 8.5bar Comment: Without Muffler
Cross Ref.	4324100410
Application	Mercedes 0004318815

	RL3511AM-F	
	Conn:27x1 Ports 1,21: M22x1.5 Ports 22,4: M12x1.5 Cut-off Pressure: 12.0bar Comment: Without Muffler	
Cross Ref.	4324100880	
Application	DWCV	3454402430
	RL3511AM-G	
	Ports 1: M22x1.5 Port 21: M22x1.5 Port 22: M12x1.5 Cut-off Pressure: 9.5bar Comment: Without Power Cable	
Cross Ref.	4324100210	
Application	Iveco	42079484
	RL3511AQ-B	
	Cut-off Pressure: 8.1bar Heat: 24V Heating Connection: M27x1 Port 1: M22x1.5 Port 21: M22x1.5 Port 22,4: M12x1.5	
Application	Truck	
	RL3511AM02	
	Port 1: M22x1.5 Port 21:M22x1.5Voss Port 22: M16x1.5Voss Cut-off Pressure: 12.5bar	
Cross Ref.	4324101130	
Application	DAF 1517967 MAN 81521026097	



Air Dryer(Single Cannister) 1.11	
RL3511AM03	
	Port 1: M22x1.5 Port 21: M22x1.5 Voss Port 22: M16x1.5 Voss Cut-off Pressure: 10.0bar
Cross Ref.	4324101170
Alternative	LA8206
Application	DAF 1517969 MAN 81521026098
RL3511AM04	
	Port 1: M22x1.5 Port 21: M22x1.5 Voss Port 22: M16x1.5 Voss Cut-off Pressure: 8.5bar
Cross Ref.	4324101150
Application	DAF 1517968 MAN 81521026119
RL3511AM05	
	Ports 1, 21: M22x1.5 Voss Port 22: M16x1.5 Voss Port 4/23: M16x1.5 Voss
Cross Ref.	4324210020
Alternative	LA6730
Application	DAF 1517975 Mercedes 0004317115
RL3511AN	
	Port 1: M22x1.5 Port 21: M22x1.5 Port 22: NPT1/4 Cut-off Pressure: 8.1bar ,Voltage: 24V Heating Connection: M27x1 Comment: Without Muffler
Application	Truck

RL3511AZ	
	Ports: 1+21=M22x1.5, 22+4=M12x1.5 Heat: 24V, Conn.: M27x1
Cross Ref.	4324200000
Application	DAF 1505972 Iveco 42530780 MAN 88521026007 Mercedes 0004316715 Neoplan 11017448
RL3511AZ-A	
Ports: 1+21=M22x1.5, 22+4=M12x1.5	
Cross Ref.	4324200020
Alternative	LA6700
Application	Volvo 1629927 DAF 1517973 Mercedes 0004313615 Neoplan 11018619
RL3511AZ-B	
Ports: 1+21=M22x1.5, 22+4=M12x1.5	
Heat: 12v, Conn.: M27x1	
Cross Ref.	4324200030
Application	Ford , DAF Volvo , RVI
RL3511AQ-H	
	Port 1: M22x1.5 Port 21: M22x1.5 Cut-out Pressure: 8.1bar Voltage: 24V Heating Connection: M27x1
RL3511AM10	
	Port 1: M22x1.5, Port 21: M22x1.5 Voss Port 22: M16x1.5 Voss, Heat: 24V Cut-off Pressure: 10bar Conn: Din72585 Bayonet +7 To+29
Cross Ref.	4324101160
Application	DAF 1518678 MAN 81521026103

Air Dryer(Single Cannister) 1.11	
 <p>RL3511AM39</p> <p>Ports 1,21: M22x1.5 Ports 22,4/23: M12x1.5 Installation hole: 3xM12x1.75-6H</p> <p>Cross Ref. 4324101920 Application Volvo 20553336</p>	
 <p>RL3511AM11</p> <p>Port 1: M22x1.5, Port 21: M22x1.5 Port 22: M12x1.5, Heat: 24V Cut-off Pressure: 8.1bar Conn: Din72585bay Onet.+7to+29 Celcius</p> <p>Cross Ref. 4324101400 Application Truck</p>	
 <p>RL3511AM12</p> <p>Port 1: M22x1.5 , Port 21: M22x1.5 Port 22: M12x1.5 , Port 4/23: M12x1.5 Cut-off Pressure: 8.5bar Heat: 24V, Conn: M27x1</p> <p>Cross Ref. 4324101520 Application Yutong 3529-00019</p>	
 <p>RL3511AM15</p> <p>Inlet Port1: M22x1.5 Outlet Port21: M22x1.5 Outlet Port22: M12x1.5 Port 4, 23: M12x1.5 Installation Plate Hole: M12x1.5 Cut-off Pressure: 12.5bar, Heat: 24V Conn: M27x1</p> <p>Application Truck</p>	
 <p>RL3511AM18</p> <p>Port 1: M22x1.5, Port 21: M22x1.5 Port 22: M12x1.5, Port 4/23: M12x1.5 Cut-off Pressure: 8.5bar, Heat: 24V Conn: M27x1</p> <p>Cross Ref. 4324100070 Application Liebherr 502657388 Yutong 3529-00019</p>	

 <p>RL3511AM01-A</p> <p>Port 1: M22x1.5 , Port 21: M22x1.5 Port 22: M12x1.5 , Port 4: M12x1.5 Cut-off Pressure: 9.4bar, Heat: 24V</p> <p>Cross Ref. 4324100830 Application Scania 1441751</p>	
 <p>RL3511AM14</p> <p>Inlet Port1: M22x1.5 Outlet Port21: M22x1.5 Outlet Port22: M12x1.5 Port4/23: M12x1.5 Installation Plate Hole: M12x1.75 Unl: 9.3bar, Heat: 24V</p> <p>Application Truck</p>	
 <p>RL3511AM24</p> <p>Port 1: M22x1.5 , Port 21: M22x1.5 Port 22: M12x1.5 , Port 4/23: M12x1.5 Cut-off Pressure: 12.5bar</p> <p>Cross Ref. 4324100330 Application Iveco 08160464 08160466</p>	
 <p>RL3511AM25</p> <p>Port 1: M22x1.5 , Port 21: M22x1.5 Port 22: M12x1.5, Unl: 9.5bar Heat: 24V, Conn: M27x1</p> <p>Cross Ref. 4324100200 Application Neoplan 110275100 Repair Kits RL3511AM-9</p>	

Air Dryer(Single Cannister) 1.11	
RL3511AM26	
	Port 1: M22x1.5 , Port 21: M22x1.5 Port 22: M12x1.5 , Port 4/23: M12x1.5 Cut-off Pressure: 12.5bar Heater: 8942600492, DC: 24V
Cross Ref.	4324100340
Application	Iveco 08160465, 08160467 DAF 1518674
RL3511AM28	
	Port 1: M22x1.5 Port 21: M22x1.5 Voss Port 22: M16x1.5 Voss Cut-off Pressure: 8.5bar Heater: 8942600492, DC: 24V
Cross Ref.	4324101140
Application	MAN 81521026118 81521026120
RL3511AM30	
	Ports 1,21: M22x1.5 Port 22: M12x1.5 Heat: 24V, Cut-off Pressure: 10bar
Cross Ref.	4324102500
Application	DAF 1505223 MAN 81521026038
RL3511AM33	
	Ports: 1+21=M22x1.5,22=M12x1.5 Port: 4=M12X1.5 Cut-off Pressure: 9.4bar, Heat: 24V
Cross Ref.	4324100810
Application	Scania 1441751

RL3511AM35	
	Ports 1,21: M22x1.5 Ports 22,4/23: M12x1.5 Installation hole: 3xM12x1.5-6H Cut-off pressure: 11bar
Cross Ref.	4324100350
Application	DAF,NATO Iveco 08160472 08160473
RL3511AM36	
	Ports 1,21: M22x1.5 Ports 22,4/23: M12x1.5 Installation hole: 3xM12x1.5-6H Cut-off pressure: 12.5bar
Cross Ref.	4324100760
Application	DAF 1518676 Iveco 41031476
RL3511AM37	
	Ports 1,21: M22x1.5 Ports 22,4/23: M12x1.5 Installation hole: 3xM12x1.5-6H Cut-off pressure: 11bar
Cross Ref.	4324100750
Application	DAF 1505220 Iveco 41031475
RL3511AF	
	Inlet Port 1: M22x1.5-6H Outlet Port 2: M22x1.5-6H Working Voltage: 24V Cut-off Pressure: (8.1 ± 0.2)bar Assembly Installation Hole: M12x1.5-6H
Cross Ref.	1417035600070
Application	Foton AuMAN 6 Series Root Van(bj1317vnpj-19) Foton AuMAN Dump (Bj3258dlpjb-19)

Air Dryer(Single Cannister) 1.11	
RL3511AA	
	Inlet Port 1:M22x1.5 Outlet Port 21:M22x1.5 Outlet Port 22:M12x1.5 Installation Plate Hole:M12x1.5
Cross Ref. Application	WG9100368471/4 CNHTC Howo
RL3511AM06	
	Inlet Port1: M22x1.5 Outlet Port21: M22x1.5 Outlet Port22: M12x1.5 Installation Plate Hole: M12x1.5 Cut-off Pressure: 10bar
Application	King Long
RL3511AM-H	
	Inlet Port1: M22x1.5 Outlet Port21: M22x1.5 Outlet Port22: M12x1.5 Installation Plate Hole: M12x1.5 Cut-off Pressure: 8.1bar Heat: 24V, Conn: M27x1
Cross Ref. Application	3511020-1H-A King Long
RL3511BA	
	Ports: Sup+Del M22x1.5 Heat: 24V Cont M12x1.5
Application Repair Kits	Dongfeng EQ153 RL3511BA-9
RL3511BF	
	Ports: Sup+Del1/2" NPT Heat: 24V Cont 1/4"NPT
Application	Dongfeng

RL3511EU	
	Cut-off Pressure: (8.1 ± 0.2)bar Inlet Port 1: M22x1.5 Outlet Port 2: M22x1.5 Working Voltage: 24V
Cross Ref. Application	13118356X0024 Foton Rowor P140
RL3511CH	
	Ports: 1+2=M22x1.5, 22=M12x1.5 Cut-off Pressure: 8.1bar, Heat: 24V
Cross Ref. Alternative Application Repair Kits	LA6210 4324111000 MAN 81521026029 81521026048 RL3511CH-9
RL3511CH-A	
	Cut-off Pressure: 8.1bar Ports: 1+2=M22x1.5, 22=M12x1.5
Cross Ref. Alternative Application	LA6200 4324102010 DAF 1518680 MAN 81521026019 Neoplan 110273630
RL3511CJ-B	
	Heat: 24V Port 1: M22x1.5 Port 21: M22x1.5 Port 22: M12x1.5 Cut-out Pressure: 8.1bar



Air Dryer(Single Cannister) 1.11	
	<p>RL3511CH16</p> <p>Ports 1,21: M22x1.5 Ports 22,4: M12x1.5 Installation hole: 3xM12x1.5-6H Cut-off pressure: (8.1 ± 0.2)bar DC: 12V</p>
	<p>RL3511NB02</p> <p>Ports: 1+2=M22X1.5 Voss 22=M16X1.5 Voss Ports 4, 23: M16X1.5 Voss</p> <p>Cross Ref. LA6734 Application Mercedes 1424, 1217, SK A0014310415</p>
	<p>RL3511NA01</p> <p>Port 1: M22X1.5 Port 21: Φ (15 ± 0.05) Port 22: Φ (9.5 ± 0.05) Cut-out Pressure: 8.5bar</p> <p>Cross Ref. LA8523</p>
	<p>RL3511NA02</p> <p>All Ports thread: M22x1.5 Cut-off pressure: 12.5bar DC: 24V</p> <p>Cross Ref. LA8008</p>
	<p>RL3511NA08</p> <p>Ports 1,2 thread: M22x1.5 Purge reservoir port: M12x1.5 Cut-off pressure: 8.1bar</p> <p>Cross Ref. LA8234 Application BMC Falcon 1100 Iveco MK130</p>



	<p>RL3511NA07</p> <p>Ports 1,21 thread: M22x1.5 Voss Port 22 thread: M16x1.5 Voss Installation hole thread: 3xM12x1.5 Cut-off pressure: 12.5bar</p> <p>Cross Ref. LA8211 Application MAN F2000, M2000 81521026097</p>
	<p>RL3511NA12</p> <p>Ports 1,21 thread: M22x1.5 Voss Port 22 thread: M16x1.5 Voss Installation hole thread: 3xM12x1.5 Cut-off pressure: 10bar DC: 24V</p> <p>Cross Ref. LA8210 Application ERF ECS,ECT,ECX MAN F2000,M2000 81521026103</p>
	<p>RL3511NA16</p> <p>Ports 1,21 thread: M22x1.5 Port 4/23 thread: M12x1.5 With Plug Cut-off pressure: 12.5bar With silencer</p> <p>Cross Ref. LA8065 Application RVI 5001874282,5001874292 5010422629,5010260640</p>
	<p>RL3511NA17</p> <p>Ports 1,21 thread: M22x1.5 Port 4/23 thread: M12x1.5 With Plug Cut-off pressure: 9.5bar DC: 24V</p> <p>Cross Ref. LA8003 Application RVI R385 5001837107</p>

Air Dryer(Single Cannister) 1.11	
RL3511NA18	
	Ports 1,21 thread: M22x1.5 Port 4/23 thread: M12x1.5 With Plug Cut-off pressure: 10bar DC: 24V
	Cross Ref. LA8004 Application RVI 5010260353
RL3511NA19	
	Ports 1,21 thread: M22x1.5 Port 4/23 thread: M12x1.5 With Plug Cut-off pressure: 8.6bar
	Cross Ref. LA8011 Application RVI G380 5010260358 Premium
RL3511NA20	
	Ports 1,21 thread: M22x1.5 Port 4/23 thread: M12x1.5 With Plug Cut-off pressure: 9.5bar
	Cross Ref. LA8016 Application RVI G380 5010260362 Premium
RL3511NA21	
	Ports 1,21 thread: M22x1.5 Port 4/23 thread: M12x1.5 With Plug Cut-off pressure: 9.5bar DC: 12V
	Cross Ref. LA8027 Application RVI

RL3511NA22	
	Ports 1,21 thread: M22x1.5 Port 4/23 thread: M12x1.5 With Plug Cut-off pressure: 8.3bar DC: 24V With silencer
	Cross Ref. LA8028 Application Skoda Liaz Tatra T163/T815
RL3511NA23	
	Ports 1,21 thread: M22x1.5 Port 4/23 thread: M12x1.5 With Plug Cut-off pressure: 12.5bar With silencer
	Cross Ref. LA8040 Application RVI S010260641 Premium
RL3511NA24	
	Ports 1,21 thread: M22x1.5 Port 4/23 thread: M12x1.5 With Plug Cut-off pressure: 12.5bar DC: 24V With silencer
	Cross Ref. LA8044 Application Irisbus Bus/Agora Citybus RVI 5010347867
RL3511NA25	
	Ports 1,21 thread: M22x1.5 Port 4/23 thread: M12x1.5 With Plug Cut-off pressure: 10bar DC: 24V With silencer
	Cross Ref. LA8050 Application Alexander Dennis R 657516 Series, Enviro, Trident



Air Dryer(Single Cannister) 1.11	
RL3511NA26	
	Ports 1,21 thread: M22x1.5 Port 4/23 thread: M12x1.5 With Plug Cut-off pressure: 8.6bar DC: 24V With silencer
Cross Ref.	LA8057
Application	RVI 5010422514 Kerax, Magnum
RL3511NA27	
	Ports 1,21 thread: M22x1.5 Port 4/23 thread: M12x1.5 With Plug Cut-off pressure: 8.1bar DC: 24V With silencer
Cross Ref.	LA8060
Application	RVI
RL3511NA28	
	Ports 1,21 thread: M22x1.5 Port 4/23 thread: M12x1.5 With Plug Cut-off pressure: 11bar DC: 24V With silencer
Cross Ref.	LA8062
Application	Iveco 9716449 97164492
RL3511NA29	
	Ports 1,21 thread: M22x1.5 Port 4/23 thread: M12x1.5 With Plug Cut-off pressure: 12.5bar DC: 24V With silencer
Cross Ref.	LA8063
Application	RVI 5010525505





	RL3511NA30	
	Ports 1,21 thread: M22x1.5 Port 4/23 thread: M12x1.5 With Plug Cut-off pressure: 9.5bar DC: 24V With silencer	
Cross Ref.	LA8064	
Application	RVI	5010525506
RL3511ZA01		
	Ports: 1+2-1=M22X1.5, 22=M18X1.5 Cut-off Pressure: 7.4bar	
Cross Ref.	M303510	
Application	TATA HCV	
RL3511ZA03		
	Port 1: M26x1.5-6H, Port 2-1: φ15 Port 22: φ15 Installation hole: 3xM12x1.5-6H Cut-off pressure: (8.1 ± 0.2)bar	
Cross Ref.	M305870	
Application	TATA HCV	
RL3511DH		
	Ports 11,21: M22x1.5 Port 22: M16x1.5 Cut-off Pressure: 12.0bar Safety: 14.5 ^{+2.5} bar 0	
Application	DAF	1505119
	Mercedes	0004301315
Repair Kits	RL3511DH-9	



Air Dryer(Single Cannister) 1.11	
RL3511DH-A	
	Ports 11,21: M22x1.5 Port 22: M16x1.5 Cut-off Pressure: 10.0bar Safety: 14.5 ^{+2.5} bar 0
Cross Ref.	9324000030
Application	Mercedes 0004301515
RL3511DG02	
	Port 12: M12x1.5 , Port21: M22x1.5 Port22: M16x1.5 Voss Port 24: M22x1.5 Voss Installation Plate Hole: M12x1.5
Cross Ref.	9324000240
Application	Mercedes 0004301315 MAN, Iveco, DAF
RL3511DG42	
	Ports 11,21,24: M22x1.5 Ports 22,23: M16x1.5 Installation hole: 2xM12x1.5-6H
Cross Ref.	9324000020
Application	Mercedes 0004301315 DAF 1505119
RL3511ES	
	Ports: 1+21=1/2NPT, 4=1/4NPT Heat: 12V Backflow: 0.7bar Comment: Heater-rockwell
Cross Ref.	4324130010
Application	Volvo
Repair Kits	RL3511ES-9







RL3511ES-A	
	Ports: 1+21=1/2NPT, 4=1/4NPT Heat: 24V Backflow: 0.7bar Comment: Heater-rockwell
Cross Ref.	4324130020
Application	Volvo
Repair Kits	RL3511ES-9
RL3511ER-B	
	Ports: M22x1.5, M12x1.5 Installation Bolt Thread: 3xM12x1.75 Working Voltage: 24V
Cross Ref.	4324150290
Application	DAF 1505232 MAN 1276700
RL3511XB02	
	Port 11: M22x1.5-6H Port 21 Installation hole spacing: (52mm Cut-off pressure: (10.5 ± 0.2)bar
Cross Ref.	LA9020
Application	Mercedes
RL3511XB03	
	Port 11 : M22x1.5 Installation Hole Thread: 2xM12x1.5-6H Cut-off pressure: (12.3 ± 0.3)bar
Cross Ref.	LA9010
Application	Mercedes Axor A002431215
RL3511XB05	
	Ports 12,24 thread: M22x1.5 Port 23 thread: M16x1.5 Cut-off pressure: (1050 ± 20)kPa DC 24V
Cross Ref.	LA8125
Application	Iveco 42536872

Air Dryer(Single Cannister) 1.11	
	<p style="text-align: center;">RL3511ED01</p> <p>Ports 1,2: M22x1.5 Ports 4, 23: M12x1.5 Installation hole thread: 3xM12x1.5-6H DC 24V</p> <p>Cross Ref. 4324251010 Application DAF 0882965</p>
	<p style="text-align: center;">RL3511ED02</p> <p>Ports 1,2: M22x1.5 Ports 4, 23: M12x1.5 Installation hole thread: 3xM12x1.5-6H DC 24V Without Heater</p> <p>Cross Ref. 4324251050 Application Volvo 21480094</p>
	<p style="text-align: center;">RL3511XD01</p> <p>P11,2: NPT1/2, P4:NPT1/4 Safety valve opening pressure: 1.38MPa DC: 24V</p> <p>Repair Kits RL3511XD01-9</p>
	<p style="text-align: center;">RL3511XD03</p> <p>Ports Thread: PT3/4, P4: PT1/4 DC: 24V</p> <p>Cross Ref. 065224, 10410109 Repair Kits RL3511XD33-9</p>
	<p style="text-align: center;">RL3511XD05</p> <p>Ports Thread: PT1/2 DC: 12V</p> <p>Cross Ref. 109685 Application American Truck</p>
	<p style="text-align: center;">RL3511XD02</p> <p>Ports thread: PT1/2, PT1/4, DC: 12V With clamps and installation bracket</p> <p>Cross Ref. 065225(PT), 10410108 Application American Truck Repair Kits RL3511XD02-9</p>

	<p style="text-align: center;">RL3511XD08</p> <p>Ports thread: NPT1/2, NPT1/4, DC: 12V With clamps and installation bracket</p> <p>Cross Ref. 065225(NPT), 10410108 Application American Truck Repair Kits RL3511XD02-9</p>
	<p style="text-align: center;">RL3511XD04</p> <p>Ports thread: PT3/4, P4: PT1/4 DC: 12V With clamps and installation bracket</p> <p>Cross Ref. 065226 Application American Truck Repair Kits RL3511XD44-9</p>
	<p style="text-align: center;">RL3511XD06</p> <p>Ports thread: PT1/2, PT1/4, DC: 12V With clamps and installation bracket & Cable</p> <p>Application American Truck</p>
	<p style="text-align: center;">RL3511XE01</p> <p>All ports thread: P11,2: PT1/2,P4: PT1/4 Installation hole thread: 4xM8,DC 24V</p> <p>Cross Ref AD-IP Application American Truck</p>
	<p style="text-align: center;">RL3511HD01</p> <p>Ports 1, 21: M22x1.5 Cut-out Pressure: 12.0 bar</p> <p>Cross Ref. 78990 Application Volvo 3962679</p>

Air Dryer Base 1.12	
	<p>RL3511EF82</p> <p>Port1: M22x1.5 Port21,22,23,24: M16x1.5 Conn: M39x1.5 DC: 24V , Cut-off Pressure: 9.5bar Comment: Base for RL3511EF</p>
	<p>RL3511DG-B</p> <p>Port 11: M22x1.5, Ports 22: M16x1.5 Port 21,23,24,25,26: M22x1.5 Cut-off Pressure: 10bar Open Press 21,22 : 6.0bar Open Press 23,24,25,26: 7.0 bar Comment: Base for RL3511DG</p>
	<p>RL3511FB</p> <p>Heat: 24V Ports: 1+21=M22x1.5, 4=M16x1.5 Comment: Base for RL3511FA</p>
	<p>RL3511AP</p> <p>Port 1: M22x1.5 Port 21: M22x1.5 Port 22: M12x1.5 Cut-off Pressure: 8.1bar Heat: 24V, Conn.: M27x1 Comment: Base for RL3511AM</p>
	<p>RL3511AP-B</p> <p>Port 1: M22x1.5 Port 21: M22x1.5 Port 22: M12x1.5 Cut-off Pressure: 8.5bar Voltage: 24V Heating Connection: M27x1 Comment: Base for RL3511AP</p>
	<p>RL3511AZ-C</p> <p>Ports: 1+21=M22, 22, 4=M12x1.5 Heat: 24V, Conn.: M27x1 Comment: Base for RL3511AZ</p>

	<p>RL3511AP-C</p> <p>Port 1: M22x1.5 Port 21: M22x1.5 Port 22: M12x1.5 Cut-off Pressure: 12.5bar Voltage: 24V Heating Connection: M27x1 Comment: Base for RL3511AP</p>
	<p>RL3511AQ</p> <p>Port 1: M22x1.5, Port 21: M22x1.5 Port 22: M12x1.5, Port 4: M12x1.5 Cut-off Pressure: 8.1bar Heat: 24V, Conn.: M27x1 Comment: Base for RL3511AM-A</p>
	<p>RL3511AQ-A</p> <p>Ports 1,21: M22x1.5, Port 22: M12x1.5 Port 4: M12x1.5 With Plug Cut-off Pressure: 8.1bar Voltage: 24V Heating Connection: M27x1 Comment: Base for RL3511AQ</p>
	<p>RL3511AQ-G</p> <p>Port 1: M22x1.5 Port 21: M22x1.5 Port 22,4: M12x1.5 Cut-off Pressure: 9.5bar Voltage: 24V Heating Connection: M27x1 Comment: Base for RL3511AQ</p>
	<p>RL3511AQ-F</p> <p>Port 1: M22x1.5 Port 21: M22x1.5 Port 22,4: M12x1.5 Cut-Off Pressure: 12.5bar Comment: Base for RL3511AQ</p>
	<p>RL3511AM13</p> <p>Inlet Port1: M22x1.5 Outlet Port21: M22x1.5 Outlet Port22: M12x1.5 Port4/23: M12x1.5 Installation Plate Hole: 3xM12x1.5 Cut-off Pressuer: 9.4bar Heat: 24V Comment: Base for RL3511AM55</p>

Air Dryer Base 1.12	
	<p>RL3511AM33R</p> <p>Ports 1,21: M22x1.5 Ports 22,4/23: M12x1.5 Installation hole thread: 3xM12x1.75-6H Cut-off pressure: 9.4bar, Heat: 24V Comment: Base for RL3511AM33</p>
	<p>RL3511AM07</p> <p>Inlet Port1: M22x1.5 Outlet Port21: M22x1.5 Outlet Port22: M16x1.5 Voss Port4/23: M12x1.5 With Plug Installation Plate Hole: M12x1.5 Heat: 24V , Conn: M27x1 Comment: Base for RL3511AQ-A</p>
	<p>RL3511AM08</p> <p>Inlet Port1: M22x1.5 Outlet Port21: M22x1.5 Outlet Port22: M12x1.5 Port4/23: M12x1.5 Installation Plate Hole: M12x1.5 Cut-off Pressure: 12.5bar Heat: 24V , Conn: M27x1 Comment: Base for RL3511AQ-A</p>
	<p>RL3511AM09</p> <p>Inlet Port1: M22x1.5 Outlet Port21: M22x1.5 Outlet Port22: M16x1.5 Voss Port4/23: M16x1.5 Voss Installation Plate Hole: M12x1.5 Heat: 24V, Conn: M27x1 Comment: Base for RL3511AZ-C</p>
	<p>RL3511AM05R</p> <p>Ports 1,21: M22x1.5 Voss Ports 22,4/23: M16x1.5 Voss Installation hole thread: 3xM12x1.5-6H Comment: Base for RL3511AM05</p>
	<p>RL3511AM38</p> <p>Installation hole thread: 3xM12x1.5-6H Cut-off pressure: 12.5bar Comment: Base for RL3511AM02</p>

	<p>RL3511CH-B</p> <p>Voltage: 24V Heating Connection: M27x1 Port 1: M22x1.5 Port 21: M22x1.5 Port 22: M12x1.5 Cut-off Pressure: (8.1 ± 0.2)bar Comment: Base for RL3511CH</p>
	<p>RL3511CJ</p> <p>Ports: 1+2=M22x1.5, 22=M12x1.5 Cut-off Pressure: 8.1bar Heat: 24V Comment: Base for RL3511CJ-B</p>
	<p>RL3511CJ-A</p> <p>Ports: 1+2=M22x1.5, 22=M12x1.5 Cut-off Pressure: 8.1bar Comment: Base for RL3511CJ</p>
	<p>RL3511DG02R</p> <p>Ports 11,21: M22x1.5 Ports 22: M16x1.5, 4/25: M10x1 With Plug Installation hole distance: (70 ± 0.25)mm Cut-off pressure: (1200 ± 30)kPa, DC: 24V Comment: Base for RL3511DG02</p>
	<p>RL3511DG01</p> <p>Port 1: M22x1.5 Port 21: M22x1.5 Port 22: M16x1.5 Voss Ports 4/25: M10x1 Voss Port 24: M22x1.5 Voss Cut-off Pressure: 12bar Heat: 24V Comment: Base for RL3511DG02</p>
	<p>RL3511DH-B</p> <p>Ports 11,21: M22x1.5 Ports 22,23: M16x1.5 Heat: 24V Cut-off Pressure: 12bar Safety: 14.5bar Comment: Base for RL3511DH</p>

Air Dryer Base		1.12
		RL3511ER
		Backflow: 0.7bar Heat: 12V Ports: 1+21=1/2 NPT, 4=1/4 NPT Comment: Base for RL3511ES
		RL3511ER-A
		Ports: 1+21=1/2 NPT, 4=1/4 NPT Heat: 24V Backflow: 0.7bar Comment: Base for RL3511ES-A
Repair Kits	RL3511ES-9	

Air Dryer Cartridge-Screw On		1.13
		RL3511KA
		Specification: M39x1.5 Comment: (12-14)bar
Cross Ref.	4324100202	
Application	RVI 5000295421 MAN 1368731 Volvo 8552063 Iveco 174767 Scania 1375997	
		RL3511KB
		Specification: RP1- $\frac{1}{4}$ Comment: 13bar
Application	Scania	

		RL3511KC
		Specification: M42x1.5 Comment: 13bar
Cross Ref.	4324102202	
Alternative	II38789F004	
Application	DAF 1505970 MAN 81521020016 Mercedes 0004293995	

		RL3511HA
		Specification: RP1- $\frac{1}{4}$ Comment: RL3511KB With Tightening Nut
Cross Ref.	4324102262 4324109262 4324109272	
		RL3511HB
		Specification: M39x1.5 Comment: 3513 001 001 0With Tightening Nut
Cross Ref.	CAS1001	

		RL3513DZ
		Specification: 1- $\frac{1}{2}$ 16UN-2B
Cross Ref.	T224	
Application	American Truck	

		RL3513DZ02
		Description: 1- $\frac{1}{2}$ 16UN-2B
Cross Ref.	T224A	
Application	American Truck	

Air Dryer Cartridge-Screw On 1.13	
	RL3511XE02
	Thread: 1 ¹ / ₄ -7UNC2B With O-ring Φ 130x5 And Φ 176x5

Air Dryer Cartridge For AD-4 1.13	
	RL3513DA
	Specification: 5/8-11UNC 2A Thread
Cross Ref.	107794, 107796
Application	American Truck

	RL3513DB
	Specification: 4x1/4-28NF Screws
Cross Ref.	104358
Application	American Truck

Air Dryer Cartridge 1.13	
	RL3513EF01
	With one O-ring Φ150xΦ3 and four Hex bolts M10x50
Cross Ref.	92528, 93522, 78964
Application	DAF, Iveco, MAN Volvo 20424148 20773824

Silencer 1.14	
	RL3511EG23
	Specification: 70db 13 bar Comment: Snap On Fitting-max Maxi. Pressure: 18.5 bar Diameter: 87mm
Cross Ref.	4324070120
Application	Mercedes 0004302070 Iveco 41002217

	RL3511AD020
	Pressure: 11bar , Diameter: 69mm Comment: Snap On Fitting-max
Cross Ref.	4324070700
Application	Iveco 41019442 Mercedes 0004300920

	RL3754AA01
	Pressure: 13bar Diameter: Φ68 Port: M 22x1.5
Cross Ref.	4324070600
Application	DAF 1193486 Mercedes 0004302370

Silencer		1.14
		RL3754EL03
	Pressure: 13bar Port: M 22x1.5	
Cross Ref.	0484210001000	
Application	DAF DB250	1207895
	Leyland CF65	
	Mercedes Actros	0004300470
	Iveco Stralis	42531613
	MAN M2000	81521016152





Air Dryer Heater Element		1.15
		K1221
	Specification: 12 Volt-100 Watt Comment: M27x1-2 Pin.+7 To+29 Celcius	
Cross Ref.	8942600442	
Application	Volvo	
		K2422
		Specification: 24 Volt-100 Watt Comment: M27x1-2 Pin.+7 To+29 Celcius
Cross Ref.	8942600402	
Application	Scania	1332658



		K1241
	Specification: 12 Volt-100 Watt Comment: Push On.+7 To+29 Celcius	
		K2442
		Specification: 24 Volt-100 Watt Comment: Push On.+7 To+29 Celcius
Cross Ref.	8942600432	
Application	Volvo	270492





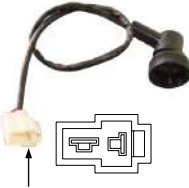



		K1231
	Specification: 12 Volt-100 Watt Comment: Din 72585 Bayonet.+7 To+29 Celcius	
		K2432
		Specification: 24 Volt-100 Watt Comment: Din 72585 Bayonet.+7 To+29 Celcius
Cross Ref.	8942600492	
Application	Faun	99707307392
	Mercedes	0005481370



		K1251
	Specification: 12 Volt-100 Watt Comment: Rockwell Type.+7 To+29 Celcius	
Cross Ref.	8942600462	
Application	Volvo	
		K2452
		Specification: 24 Volt-100 Watt Comment: Rockwell Type.+7 To+29 Celcius
Cross Ref.	8942600472	

		K1261
	Specification: 12 Volt-100 Watt Comment: M27x1.+7 To+29deg Celcius	
Cross Ref.	I130654	

Air Dryer Heater Element 1.15	
	K2462
	Specification: 24 Volt-100 Watt Comment: M27x1.+7 To+29deg Celcius
Cross Ref.	I87122
K1271	
	Specification: 12 Volt-100 Watt Comment: La6..la7..+7 To+29deg Celcius
K2472	
	Specification: 24 Volt-100 Watt Comment: La6..la7..+7 To+29deg Celcius
KX013	
	Specification: M27x1 Universal Cable Comment: Use To Connect To Any Wiring Loom
Cross Ref.	KX013
RL3511LB01	
	Ad-9 Ad-sp Ad-ip R955205
Cross Ref.	109869, 109871
Application	American Truck
RL3511LB02	
	Dc: 24V Tur Non Temperature: (7±6)°C Cut Out Temperature: (29.5±3)°C
RL3511LB35-8	
	Specification: M27x1 Universal Cable Comment: Use To Connect To Any Wiring Loom



Anti-Freezer Pump 1.16	
RL3529AA	
	Ports: 11+12=M22x1.5
Cross Ref.	LA1100
Application	IKARUS
RL3529BA	
	Ports: 11+12=M22x1.5
Cross Ref.	313002
Application	IKARUS

Repair Kits	Kits P/N	Repair Kits For	Cross Ref.	Application
	RL3511AM-9	RL3511AM	4324100020	RVI 5000296596 MAN 1368719
	RL3511BA-9	RL3511BA		
	RL3511CH-9	RL3511CH	187917	
	RL3511DH-9	RL3511DH	9324000002	DAF 1519201 Mercedes 0004301415
	RL3511ER01	RL3511ER	R950013	Truck
	RL3511ER02	RL3511ER	R950014	Truck
	RL3511ER03	RL3511ER	R950017	Truck
	RL3511ES-9	RL3511ES		

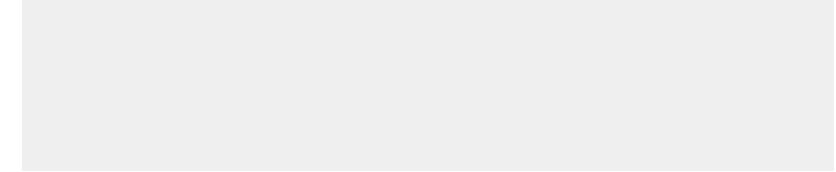



Repair Kits	Kits P/N	Repair Kits For	Cross Ref.	Application
	RL3511FA-9	RL3511FA	4324310022	RVI 5021170081 Volvo 3094804 DAF 1505978
	RL3511XD01-9	RL3511XD01		
	RL3511XD02-9	RL3511XD02	107695	
	RL3511XD33-9 RL3511XD44-9		5004341 5004342	





Air Protection		2
Four Circuit Protection Valve		2.01
Multi Circuit Protection Valve		2.02
Two Circuit Protection Valve		2.03
Three Circuit Protection Valve		2.04
Safety Valve		2.05
Charging (Overflow) Valve		2.06
Pressure Limiting Valve		2.07
Pressure Protection Valve		2.08
Transmission Air Regulator		2.09
Pressure Switch		2.10



Four Circuit Protection Valve		2.01
RL3515CA		
	Ports: Port1 M22x1.5 Port 11, 12,21,22,23,24: M16x1.5 Open Press 21, 22, 23, 24: 7.0bar	
Cross Ref.	AE4162	
Alternative	9347022210	
Application	MAN M90	81521515056
RL3515CA05		
	Port 1: M22x1.5-6H Ports 11,12,21,22,23,24: M16x1.5-6H Ports 21/22 Opening pressure=0kPa Port 23 =(700-730)kPa Port 24 =(660-690)kPa	
Cross Ref.	AE4448	
Application	MAN	81521516079
RL3515CA06		
	Port 1: M22x1.5-6H Ports 11,12,21,22,23,24: M16x1.5-6H Max Operating pressure: 10bar Ports 21/22=0bar, 23/24=5.8bar	
Cross Ref.	AE4452	
Application	Volvo	1075765



RL3515LF		
	Port 1: M22x1.5 Port 21,22,23,24: M16x1.5 Open Press 21, 22, 23, 24: 7.0bar Comment: Without Feed Back 23+24	
Cross Ref.	AE4158	
Application	Iveco	2516914
	Neoplan	
	RVI	5000121755
RL3515LF-A		
	Port 1: M22x1.5 Port 21,22,23,24: M16x1.5 Open Press 21, 22, 23, 24: 6.5bar Comment: No Feed Back 23+24	
Cross Ref.	AE4168	
Alternative	9347021000	
Application	Ford, Neoplan	
	Volvo	1130617
RL3515LF-B		
	Port 1: M22x1.5 Port 21,22,23,24: M16x1.5 Open Press 21, 22, 23, 24: 7.0bar Comment: Feed Back All Circuits	
Cross Ref.	AE4170	
Application	Mercedes	A0014314006
RL3515LF-D		
	Port 1 : M22x1.5 Port 21,2,23,24 :M16x1.5 Open Press 21,22:7bar, 23,24 :5.7bar	
Cross Ref.	AE4427	
Application	Volvo FL6 , B6	3124013





Four Circuit Protection Valve 2.01	
	<p align="center">RL3515LF-E</p> <p>Port 1: M22x1.5 Port 21,22,23,24: M16x1.5 Open Press 21,22,23,24: 6.3bar</p>
	<p>Cross Ref. AE4428 Application Volvo 8152899</p>
	<p align="center">RL3515LF-F</p> <p>Port 1: M22x1.5 Port 21,22,23,24: M16x1.5 Open Press 21,22,23,24: 6.5bar</p>
	<p>Cross Ref. AE4179 Application DAF 271944</p>
	<p align="center">RL3515LF01</p> <p>Port 1: M22x1.5 Ports 21,22,23,24: M16x1.5 Open Pressure 21,22,23,24: 5.5bar Close Pressure 21,22,23,24 > 4.2bar</p>
	<p align="center">RL3515LF02</p> <p>Port 1: NPT1/2 Ports 21,22,23,24: NPT3/8 Opening Pressure: 21,22=6.7bar 23=7.0bar,24=6.7bar</p>
	<p align="center">RL3515LF03</p> <p>Port 1: M22x1.5 Ports 21,22,23,24: M16x1.5 Opening Pressure 21,22,23,24 : 5.5bar Close Pressure 21,22,23,24 > 4.2bar Comment: Without Feed Back 23,24</p>

	<p align="center">RL3515LF06</p> <p>Port 1: M22x1.5 Ports 21,22,23,24: M16x1.5 Opening Pressure: 21=8.0bar 22,23,24=6.7bar Comment: RL3515LF-B With Black Coating</p>
	<p>Cross Ref. AE4170 Application Mercedes Daimler</p>
	<p align="center">RL3515LA</p> <p>Port 1: M22x1.5 Ports 21,22,23,24: M16x1.5 Open Pressure: 21,22,24=5.9 bar 23=6.1bar</p>
	<p>Cross Ref. 35GC2-15010 Application BYD K9-3535010 King Long 3524440 CNHTC Howo WG9000360366</p>
	<p align="center">RL3515LA05</p> <p>Port 1: M22x1.5-6H Rest Ports: 4xM16x1.5 Max Operating pressure: 10bar Ports 21, 22, 24=6.7bar, 23=7.0bar</p>
	<p>Cross Ref. AE4178 Application Mercedes 0014315800 MAN 81521516065</p>
	<p align="center">RL3515LA15</p> <p>Port 1: M22x1.5-6H Rest Ports: 4xM16x1.5 Max Operating pressure: 10bar Ports 21, 22=6.7bar, 23=7.0bar</p>
	<p>Cross Ref. AE4412 Application RVI 5010067820</p>

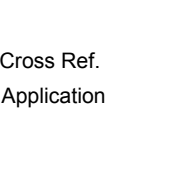
Four Circuit Protection Valve 2.01	
RL3515LA17	
	Port 1: M22x1.5-6H Ports 21/22/23/24: M16x1.5-6H Max Operating pressure: 10bar Ports 21/22=0bar, 23=7.3bar, 24=6.5bar
Cross Ref.	AE4443
Application	DAF 1238512
RL3515LA63	
	Port 1: M22x1.5 Ports 21,22,23,24: M16x1.5 Opening Pressure: 21,22,24=5.6bar 23=5.9bar
Cross Ref.	6125G02-3533010
Application	King Long
RL3515LS	
	Port 1: M18x1.5 Ports 21,22: M18x1.5 Port 24: M10x1 Opening Pressure: (5.8-6)bar
Application	Shenyang Brilliance JinBei
RL3515QA01	
	Inlet Port1: M22x1.5 Voss Outlet Ports21,22,23,24: M22x1.5 Voss Opening Pressure 23: 5.9bar Opening Pressure 24: 6.1bar
Cross Ref.	K001242
Application	TATA Novus 5542

RL3515QA02	
	All Ports: M22x1.5 Voss Max Operating pressure: 10bar Ports 21, 22=0bar, 23, 24=7.0bar
Cross Ref.	AE4404
Application	Mercedes 0024317606
RL3515QA04	
	All Ports: M22x1.5 Voss Max Operating pressure: 10bar Ports 21/22/24=6.5bar, 23=7.3bar
Cross Ref.	AE4437
Application	DAF 1238505
RL3515QA05	
	All Ports: M22x1.5 Opening pressure: Ports 21/22/24=(660-690)kPa Port 23=(670-700)kPa
Cross Ref.	AE4422
Application	MAN M2600 81521516073
RL3515TA03	
	Port 1: M22x1.5 Ports 21,22,23,24: $\phi 9$ Open Pressure 21,22: 0.7bar Open Pressure 23,24: 7bar
Cross Ref.	AE4440
Application	RVI 501216965
RL3515XD01	
	Port 1: M22x1.5 Ports 21,22,23,24: $\phi 9$ Open Pressure 21, 22, 24: 7bar Open Pressure 23: 7.3bar
Cross Ref.	AE4605
Application	RVI 5010422971 Iveco 5006143813



Four Circuit Protection Valve		2.01
		RL3515DA
	Port1: M22x1.5 Port 11,12, 21,22,23,24 : M16x1.5 Open Press 21, 22, 23, 24: 7.0bar	
Cross Ref.	9347022100	
Application	DAF 1518178 MAN 81521516020 Mercedes 0014313506 0014319806	
		RL3515DA05
	Port 1: M22x1.5 Ports 11, 12, 21, 22, 23, 24: M16x1.5 Opening pressure: (670-700)kPa	
Cross Ref.	9347022210	
Application	DAF 1518179 MAN 81521515056 Mercedes 0014313506	
		RL3515DA06
	Port 1: M22x1.5 Ports 11, 12, 21, 22, 23, 24: M16x1.5 Opening pressure: 21, 22=(670-700)kPa 23, 24=(620-650)kPa	
Cross Ref.	9347022400	
Application	DAF 1518180 MAN 81521516037 Mercedes 0024209224	
		RL3515WA01
	Port1: M22x1.5 Voss Ports 21,22,23,24: M22x1.5 Voss Ports 21,22,23,24 Opening Pressure: 7.0bar	
Cross Ref.	9347022600	
Alternative	AE4402	
Application	DAF 1518181 Mercedes 0024317306	



		RL3515KA
	Inlet Port 1: M22x1.5-6H Outlet Port 21,22,23,24: M16x1.5-6H Open Pressure: 21,22,24 = 5.9bar 23 = 6.1bar	
Cross Ref.	1106635615001	
Application	Foton Ollin Lifan Junma	
		RL3515KE
	Port1: M22x1.5 Port 21 22,23,24: M16x1.5 Open Press 21, 22, 23, 24: 7.0bar	
Cross Ref.	9347022500	
Alternative	AE4170, 314039001	
Application	DAF 1519548	
		RL3515KD
	Inlet Port 1: M22x1.5 Outlet Port 21,22,23,24: M16x1.5 Open Pressure: 21, 22, 23, 24 = 5.8bar	
Cross Ref.	13137356X0003	
Application	Foton Rowor P140	
		RL3515KE02
	Inlet Port 1: M18x1.5 Outlet Ports 21,22,23,24: M18x1.5 Open Pressure: 21,22,23,24 = 6.0bar	
Cross Ref.	13082356M0005	
Application	Foton Rowor I	

Four Circuit Protection Valve 2.01		
RL3515EA01		
 <p>Port1: M22x1.5 Ports 21,22,23,24: M16x1.5 Opening Pressure 21,22,24: 6.9bar Opening Pressure 23: 7bar</p>		
Cross Ref.	9347023220	
Alternative	AE4447	
Application	DAF	1518185
	MAN	81521516074
RL3515EA02		
 <p>Ports 1: M22x1.5 Ports 21,22,23,24: M16x1.5 Opening Pressure 21,22,23,24: 5.5bar</p>		
RL3515EA03		
<p>Port 1: M22x1.5 Ports 21,22,23,24: M16x1.5 Opening Pressure 21,22,23,24: 7.9bar</p>		
Cross Ref.	9347020820	
Alternative	AE4171 314036001	
Application	DAF	1518176
	Iveco	04720937
RL3515EA04		
<p>Port 1: M22x1.5 Ports 21,22,23,24: M16x1.5 Opening Pressure: 21,22,24=6.5bar 23=7.5bar</p>		
Cross Ref.	9347023870	
Application	Scania	1356635
	DAF	1505399



RL3515EA05		
<p>Port 1: M22x1.5 Ports 21,22,23,24: M16x1.5 Opening Pressure: 21,22,24=7bar,23=7bar</p>		
Cross Ref.	9347023020	
Alternative	AE4190 314059003	
Application	DAF	1519209
	Iveco	04789811
RL3515EA06		
<p>Port 1: M22x1.5 Ports 21,22,23,24: M16x1.5 Opening Pressure: 21,22=6.0bar 23,24=5.5bar</p>		
Cross Ref.	9347020000	
Application	DAF	504507
	Iveco	5000465223
RL3515EA07		
<p>Port 1: M22x1.5 Ports 21,22,23,24: M16x1.5 Opening Pressure: 21,22=7.0bar 23,24=6.0bar</p>		
Cross Ref.	9347023900	
Application	MAN , Mercedes, Iveco Volvo, BMC, Scania	
RL3515EA09		
 <p>Port 1: M22x1.5-6H Ports 21, 22, 23, 24: M16x1.5-6H Ports 21, 22 Opening pressure=(670-700)kPa Ports 23, 24 =(620-650)kPa</p>		
Cross Ref.	9347020410	
Application	DAF	1518174
	Iveco	02494268
	MAN	81521516013



Four Circuit Protection Valve 2.01	
RL3515EA10	
	Port 1: M22x1.5-6H Ports 21, 22, 23, 24: M16x1.5-6H Ports 21, 22 Opening pressure=(570-600)kPa Ports 23, 24 =(520-550)kPa
Cross Ref.	9347020400
Application	DAF 0112227 Faun 1614170 Iveco 02516914
RL3515EA-A	
	Port1: M22x1.5 Ports 21,22,23,24: M16x1.5 Opening Pressure 21, 22, 23, 24: 6.8bar
Cross Ref.	9347023000
Alternative	AE 4158, 314018001
Application	MAN 81521516007 Mercedes 0014313006 0024310606
Repair Kit	RL3515EA-A-9
RL3515EA-B	
	Port1: M22x1.5 Ports 21,22,23,24: M16x1.5 Opening Pressure 21, 22, 23, 24: 6.8bar
Cross Ref.	9347023200
Alternative	AE 2762, 314018001
Application	DAF 1518184 MAN 81511516050 Mercedes 0024319406 Neoplan 110251300
Repair Kit	RL3515EA-B-9
RL3515EA-C	
	Port 1: M22x1.5 Ports 21,22,23,24: M16x1.5 Opening Pressure 21, 22, 23, 24: 7.0bar
Cross Ref.	9347023400
Alternative	AE4158, 314023001
Application	DAF 1518186 Mercedes 0014313006 RVI 5000121755 Iveco 4205 1732
Repair Kit	RL3515EA-C-9

	RL3515EA-D	
	Port 1: M22x1.5 Ports 21,22,23,24: M16x1.5 Opening Pressure 21, 22, 23, 24: 6.8bar	
Cross Ref.	9347023800	
Alternative	AE4158	
Application	DAF	0644243
	Iveco	61598164
Repair Kit	RL3515EA-D-9	
	RL3515EA-G	
	Port 1: NPT1/2 Ports 21,22,23,24: NPT3/8 Opening Pressure 21,22,23,24: 6.8bar	
	RL3515EA-H	
	Port 1: M22x1.5 Ports 21,22,23,24: M16x1.5 Opening Pressure 21,22,23,24: 6.5bar	
Cross Ref.	9347023810	
Application	DAF	0271944
	Scania	307605
	RL3515XB01	
	Port 1: NPT3/8 Ports 21,22,23,24: NPT1/4 Opening Pressure: Ports 21,22:0kPa Port 23:(630-660)kPa , Port 24:(530-560)kPa	
Application	HINO	S4457-01330
	RL3515XB02	
	Port 1: NPT3/8 Ports 21,22,23,24: NPT1/4 Opening Pressure: Ports 21,22:0 kPa Port 23:(630-660)kPa , Port 24:(530-560)kPa Comment: With 3515 019 001 0 Installation Direction Different	
Application	HINO	S4457-01331

Four Circuit Protection Valve 2.01	
RL3515RA01	
	Port 1: M22x1.5 Ports 21,22,23,24: M16x1.5 Opening Pressure 21, 22: 0 bar Opening Pressure:23, 24: 6.4 bar
Cross Ref.	M30294
Application	India Truck
RL3515RA02	
	Port 1: M22x1.5 Ports 21,22,23,24: M16x1.5 Opening Pressure: 21,22=0kPa 23,24=(620-650)kPa
Application	India Truck
RL3515MA	
	Port1: M22x1.5 Ports 21,22,23,24: M16x1.5 Opening Pressure 21, 22, 23, 24: 5.9bar
Cross Ref.	9347140100
Alternative	AE4422
Application	DAF 1524857 Iveco 5801102059 MAN 81521516073 81521516082
Repair Kit	RL3515MA-9
RL3515MB	
	Port1: 1/2NPT Port 21,22,23,24: 3/8NPT Opening Pressure 21, 22, 23, 24: 6.8bar
Cross Ref.	9347140130
Application	MAN

RL3515MA35	
	Port 1: M22x1.5-6H Ports 21,22,23,24: M16x1.5-6H Opening Pressure 21,22,24: (670-700)kPa Ports 23: (720-750)kPa
Cross Ref.	9347141250
Application	DAF 1505403 MAN ZG046450002 Mercedes 0034316906
RL3515MA37	
	Port 1: M22x1.5-6H Ports 21,22,23,24: M16x1.5-6H Opening Pressure 21,22,24: (670-700)kPa
RL3515MB01	
	Port 1: M22x1.5 Ports 21,22,23,24: M16x1.5 Opening Pressure 21,22,23,24: 7.5bar
Cross Ref.	9347141190
Application	Iveco 99480157
RL3515MB02	
	Port 1: M22x1.5 Ports 21,22,23,24: M16x1.5 Opening Pressure: 21,22,24=6.5bar 23=7.4bar
Cross Ref.	9347142110
Application	Scania 1431049 DAF 1505406

Four Circuit Protection Valve 2.01	
RL3515MB03	
	Port 1: Φ20.5 Ports 21,22,23,24: NPT3/8 Opening Pressure: 21,22,24=6.0bar 23=7.0bar
Cross Ref.	9347141520
Application	HMC
RL3515MB04	
	Port 1: M22x1.5 Ports 21,22,23,24: M16x1.5 Opening Pressure: 21,22=6.9bar 23,24=7.2bar
Cross Ref.	9347141230
Application	DAF 1518192 Leyland Ache908
RL3515MA61	
	Ports: M22x1.5 Voss Max Operating pressure: 13bar Ports 21,22,24=5.9 bar, 23=6.1bar
Cross Ref.	59480-Y3B00.2
Application	JAC LCV III
RL3515MB05	
	Ports: All M22x1.5 Voss Opening Pressure: 21,22,24=6.9bar 23=7.0bar
Cross Ref.	9347144030
Application	Foton CNHTC WG9000360523/1

	RL3515MB06	
	All Ports: M22x1.5 Voss Ports 21,22,24 Opening Pressure=(660-690)kPa Port 23 =(720-750)kPa	
Cross Ref.	9347140080	
Application	MAN	81521516073
	RL3515MB07	
	Port 1: M22x1.5-6H Ports 21,22,23,24: M16x1.5-6H Ports 21,22,24 Opening pressure=(660-690)kPa Port 23 =(720-750)kPa	
Cross Ref.	9347140090	
Application	MAN	81521516091
	RL3515PA	
	Port 1: M22x1.5 Ports 21,22,23,24: M16x1.5 Opening Pressure 21: 4.2 bar, 22: 5.6 bar Opening Pressure 23: 5.2 bar, 24: 6.0 bar	
Application	Foton	
Repair Kit	RL3515PA-9	
	RL3515XA01	
	Port 1: M22x1.5 Ports 11,12,21,22,23,24: M16x1.5 Opening Pressure 23,24: 6.3 bar	
Cross Ref.	AE4604	
Application	Volvo	3197588



Four Circuit Protection Valve 2.01	
RL3515XA02	
	Ports 1,22,23,24: $\Phi 15 \pm 0.05$ Port 21: M22x1.5 Opening Pressure: Ports 21,22=0kPa Ports 23,24=(640-670)kPa
Cross Ref.	263243700155
RL3515XA03	
	Ports 1,21,22,23,24:M22x1.5 Voss Opening Pressure: Ports 21,22=0kPa Ports 23,24=(640-670)kPa
Application	MAN
RL3515XA09	
	All Ports Thread: M16x1.5 Ports 21, 22 Opening Pressure: 750kPa Ports 23, 24 Opening Pressure: 800kPa
Cross Ref.	AE4608
Application	Iveco 42536555
RL3515XA07	
	Port 1 thread: M22x1.5 Port 21/22/23/24 thread: M16x1.5 Ports 21/22 Opening Pressure=0kPa Ports23/24=(770-800)kPa
Cross Ref.	AE4615
Application	Mercedes Enviro Mercedes Atego Evobus Axor

RL3515XA10	
	Port 1 Thread: M22x1.5 Ports 21, 22, 23, 24 Thread: M16x1.5 Opening Pressure 21, 22, 24: 700kPa Port 23 Opening Pressure: 730kPa
Cross Ref.	AE4611
Application	Iveco, Truck
RL3515XA11	
	Port 1 thread: M22x1.5 Ports 21, 22, 23, 24 thread: M16x1.5 Ports 21, 22, 24 Opening Pressure: 700kPa Opening Pressure 23: 720kPa
Cross Ref.	AE4612
Application	Mercedes BMC Falcon 1100/Buses
RL3515XA12	
	Port 1 thread: M22x1.5 Ports 21, 22, 23, 24 thread: M16x1.5 Opening Pressure 21, 22, 24: 690kPa Port 23 Opening Pressure: 700kPa
Cross Ref.	AE4613
Application	ERF ECS, ECT, ECX MAN F 2000/Bus 81521516093
RL3515XA13	
	Port 1 thread: M22x1.5 Ports 21, 22, 23, 24 thread: M16x1.5 Opening Pressure 21, 22, 23, 24: (750-780)kPa
Cross Ref.	AE4641
Application	Iveco, Truck

Four Circuit Protection Valve 2.01	
RL3515XA14	
	Port 1 thread: M22x1.5 Ports 21, 22, 23, 24 thread: M16x1.5 Opening Pressure 21, 22, 23, 24 : 660kPa
Cross Ref.	AE4642
Application	Iveco, Truck
RL3515XA15	
	Port 1 thread: M22x1.5 Ports 21, 22, 23, 24 thread: M16x1.5 Opening Pressure 21, 22, 23, 24: 700kPa
Cross Ref.	AE4643
Application	Iveco, Truck
RL3515XA16	
	Port 1 thread: M22x1.5 Ports 21, 22, 23, 24 thread: M16x1.5 Opening Pressure 21, 22: (670-700)kPa Ports 23, 24 With plug
Cross Ref.	AE4644
Application	Iveco, Truck
RL3515XA17	
	Port 1 thread: M22x1.5 Ports 21, 22, 23, 24 thread: M16x1.5 Opening Pressure 21, 22: (670-700)kPa Ports 23, 24 With plug
Cross Ref.	AE4645
Application	Iveco, Truck

	RL3515XA18
	Port 1 thread: M22x1.5 Ports 21, 22, 23, 24 thread: M16x1.5 Opening Pressure 21, 23: 750kPa Ports 22, 24 Opening Pressure: (750-800)kPa
Cross Ref.	AE4646
Application	Iveco, Truck
	RL3515XA19
	Port 1 thread: M22x1.5 Ports 21, 22, 23, 24 thread: M16x1.5 Opening Pressure 21, 22, 23: (620-650)kPa Port 24 With plug
Cross Ref.	AE4648
Application	Iveco, Truck
	RL3515XC01
	Ports: M22x1.5, M16x1.5
Cross Ref.	9347147400
Application	Volvo 20382309, 20452151 20716313, 20755195

Multi Circuit Protection Valve 2.02	
	RL3515SA
	Ports: Port1 Flange Port Main Feeds M22x1.5 Voss Open 21,22: 6.0 bar, Open 23, 24: 7.0 bar Limit 3+4: 8.5 bar
Cross Ref.	9347050020
Application	Mercedes 0034315506
Repair Kit	RL3515SA-9
	RL3515SA02
	Ports: All M22x1.5 Voss Open Pressure 21,22: (600 ± 20)kPa Ports 23,24,25,26: (700 ± 20)kPa





Multi Circuit Protection Valve 2.02	
RL3515AH10	
	Port 1: M16x1.5 Ports 21-24, 25, 26: M22x1.5 Ports 21, 22, 24 Opening Pressure: 700kPa Port 23 Opening Pressure: 750kPa
Cross Ref.	AE4528
Application	DAF 1607416
RL3515AH11	
	Port 1: M16x1.5 Ports 21-24, 25, 26: M22x1.5 Ports 21, 22, 24 Opening Pressure: 700kPa Port 23 Opening Pressure: 750kPa
Cross Ref.	AE4529
Application	DAF 1607417
RL3515AH12	
	All Ports: M22x1.5 Ports 21-24 Opening Pressure: 620 kPa
Cross Ref.	AE4534
Application	Foden
RL3515AE01	
	Ports: M22x1.5 Voss Opening Pressure 23 to 28: (770-800)kPa
Cross Ref.	AE4800
Application	Mercedes 0034319706

Two Circuit Protection Valve 2.03	
RL3515HB	
	Port1: M22x1.5 Ports 21,22: M16x1.5 Opening Pressure 21, 22: 6.0bar
Cross Ref.	9347000400
Alternative	314008011
Application	DAF 0867660
	Mercedes 0014314606
	MAN 81521516008
	RVI 5000514869
Repair Kit	RL3515HB-9
RL3515AF01	
	All Ports Thread M22x1.5 Opening Pressure 21: (580-610)kPa Other Port 21: (480-610)kPa
Application	Kamaz 100-3515110

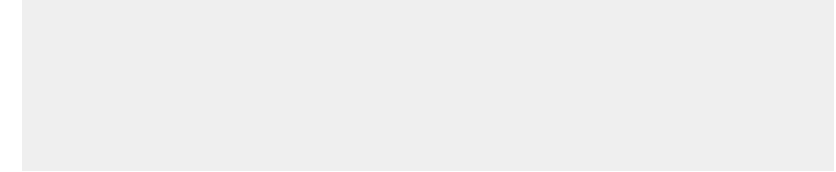
Three Circuit Protection Valve 2.04	
RL3515AG01	
	Port 1 Thread: M22x1.5 Ports 21,22 ,23 Thread: M16x1.5 Opening Pressure 21,22: (510-540)kPa Opening Pressure 23: (470-500)kPa
Application	Kamaz 100-3515210

Repair Kits	Kits P/N	Repair Kit For	Cross Ref.	Application
	RL3515LF-9 RL3515LF-A-9 RL3515LF-B-9 RL3515CA-9	RL3515LF RL3515LF-A RL3515LF-B RL3515CA	181171	
	RL3515DA-9 RL3515KB-9	RL3515DA RL3515KB	9349010052	DAF 1519548 Iveco 42493396 Mercedes 0035860943
	RL3515EA-A-9	RL3515EA-A	9347020042	Iveco 42487276 MAN 81521516046 Mercedes 0025865942
	RL3515EA-B-9	RL3515EA-B	9347020012	DAF 1519205 Iveco 93162184 MAN 81521516012 Mercedes 0015865343
	RL3515EA-C-9	RL3515EA-C	9349010022	Scania 1344213
	RL3515EA-D-9	RL3515EA-D	9347020062	Scania 319480
	RL3515MA-9	RL3515MA		
	RL3515PA-9	RL3515PA		
	RL3515SA-9	RL3515SA		
	RL3515HB-9	RL3515HB	9347000002	Mercede 0025861043

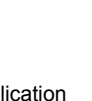

Safety Valve		2.05	
		RL3513HA	
		Setting: 155 psi (11.0 bar) Port: 1/4"N PT	
Cross Ref.	KX175/1		
Application	Universal		
		RL3513HA08	
		Port thread NPT1/4 Opening pressure: (980 ± 30)kPa	
		Application	Universal
		RL3513HB	
		Setting: 155 psi (11.0 bar) Port: M16X1.5	
Application	Volvo	8151922	
		RL3513HF	
		Setting: 9.5 bar Port: M22x1.5	
Application	Universal		
		RL3513JA	
		Setting: 150 psi (10.5 bar) Port: 1/4"NPT	
Cross Ref.	205105		
Application	Universal		

		RL3513MA	
		Setting: 11 bar Ports: 1/4" NPT	
Cross Ref.	KN31400		
Application	Universal		
		RL3513MB	
		Setting: 12bar Ports: 3/8" NPT	
Application	Universal		
		RL3513XA01	
		Setting: 130 psi (9.0bar) Thread: 1/4" NPT	
Application	Universal		
		RL3513XA02	
		Setting: 150psi Port: 1/4"NPT	
Cross Ref.	284142		
Application	Universal		
		RL3513XC01	
		Ports Thread: NPT1/4 Setting: 13.8 bar	
Cross Ref.	5001909		
Application	American Truck & Trailer		



Charging (Over flow) Valve 2.06	
RL3531FA	
	Ports: 1=1/2"NPT Female 2=1/2"NPT Male Setting: 6.2 bar
Cross Ref.	065677
Application	American Trailer
RL3531DA	
	Ports: SUP=3/8" NPT Del=1/2" NPT Male Setting: 6.0 bar
Application	Trailer
RL3531BA	
	Ports: M22x1.5 Return Flow: With Return Flow Comment: Adjustable (2.0-10.0)bar Setting: 6.5 bar
Cross Ref.	314013005
Alternative	4341000250
Application	Trailer
RL3531BA-A	
	Ports: M22x1.5 Setting: 5.5bar Return Flow: Without Return Flow Comment: Adjustable (2.0-10.0)bar
Cross Ref.	314012003
Alternative	4341001240
Application	Trailer



	RL3531BA-B	
	Ports: M22x1.5 Setting: 5.0 bar Return Flow: Limited Return Flow Comment: Adjustable (2.0-10.0)bar	
Cross Ref.	314014004	
Alternative	4341002210	
Application	Trailer	
	RL3531BA11	
	Ports M22x1.5 Opening pressure: (1000 ± 30)kPa	
Cross Ref.	314114001	
	RL3531BA12	
	Ports M22x1.5 Opening pressure: (500-570)kPa	
	RL3531GA	
	Ports: 1+2=M22x1.5 Setting: 6.0 bar Comment: Adjustable (3.5-6.0) bar	
Cross Ref.	0481009026000	
Application	Volvo	1587070
	RL3531GA10	
	Ports Thread M22x1.5 Output Pressure: (750 ± 15)kPa	
Cross Ref.	0481009047000	
Application	Volvo	FL10, FL7

Charging (Over flow) Valve 2.06	
RL3531GB	
	Setting: 6.0 bar Ports: 1+2=M16x1.5 Comment: Adjustabl(3.5-6.0) bar
Cross Ref.	0481009017000
Application	MAN 88521016201 Mercedes 0004294544
RL3531GC	
	Setting: 6.0 bar Ports: 1+2=3/8 NPT Comment: Adjustable(3.5-6.0) bar
RL3531GB15	
	Ports: 1+2=M16X1.5 Delivered Pressure: (3.5 ± 0.15)bar
Cross Ref.	0481009014000
Application	Mercedes A0004317383
RL3531GB16	
	Ports: 1+2=M16x1.5 Delivered Pressure:(8.0 ± 0.15)bar
Cross Ref.	0481009029000
Application	DAF 369518 Mercedes A0014316914
RL3531GD	
	Ports: 1+2=M16x1.5 Delivered Pressure:(7.3 ± 0.15)bar
Cross Ref.	0481009022000
Application	Mercedes A0014315706 MAN 8154016150



RL3531GE	
	Ports: 1+2=M16x1.5 Delivered Pressure: (9.5-0.15)bar
Cross Ref.	0481009021000
Application	Mercedes A0014315606
RL3531GG	
	Ports: 1+2=M16x1.5 Delivered Pressure: (10 ± 0.15)bar
Cross Ref.	0481009102000
RL3531VA01	
	Setting: 7.6 bar Ports: 1+2=M22X1.5
Cross Ref.	AC152DX
Application	Scania 322924
Repair Kit	RL3531VA01-9
RL3531PA	
	Opening Pressure: 4.0 bar Ports: Supp+Del 1/4" NPT
RL3531WA01	
	Ports: M22x1.5 Opening Pressure: 6.0bar Return Flow: No Return Flow Comment: Adjustable (2.0-10.0)bar
Cross Ref.	4341001250
Application	DAF 0633492 Mercedes 0004297544 Volvo 0052365395
Repair Kit	RL3531WA-9

Charging (Over flow) Valve 2.06	
RL3531WA02	
	Ports: M22x1.5 Opening Pressure: 6.0bar Return Flow: With Return Flow Comment: Adjustable (2.0-10.0)bar
Cross Ref.	4341000240
Application	DAF 011044 Iveco 02516827 Mercedes 0004295544 MAN 81521107011
Repair Kit	RL3531WA02-9
RL3531WA04	
	Ports: M22x1.5 Opening Pressure: 6.0bar Return Flow: Limited Return Flow Comment: Adjustable (2.0-10.0)bar
Cross Ref.	4341002210
Alternative	DR4208
Application	Volvo 1580313 Iveco 2516829 Mercedes 0024296844
Repair Kit	RL3531WA03-9
RL3531WA06	
	Port1: M22x1.5 Port2: M22x1.5 Opening Pressure: 5.0bar
Cross Ref.	4341001230
Alternative	DR4128
Application	Mercedes 0004297144 Volvo 345209 Iveco 2515034
RL3531WA07	
	Port 1: M22x1.5, Port 2: M22x1.5 Opening Pressure: 5.5 bar
Cross Ref.	4341001240
Alternative	DR4305
Application	Mercedes 0004296344 RVI 5000589984 Volvo 1134344

RL3531WA08	
	Port: M22x1.5 Charging pressure 4.5bar
Cross Ref.	4341001220
Application	DAF 0110442 Iveco 02516823 MAN 81521106009 Mercedes 0004296444
RL3531WA09	
	Port: M22x1.5 Charging pressure 4.5bar
Cross Ref.	4341002200
Application	DAF 0110443 Iveco 01135961 MAN 81521106013 Mercedes 0004292044
RL3531WA11	
	Ports M22x1.5 Opening pressure: (1000-1030)kPa
Cross Ref.	4341000470
Application	DAF 1236573 MAN 81521106101 Mercedes 0044298144
RL3531NA	
	Ports: 1+2=M22x1.5 Setting: 4.0bar Comment: Adjustable 3.5-6.0bar
Cross Ref.	4750100250
Application	Liebherr 502984577

Pressure Limiting Valve 2.07	
RL3531NA04	
	Port Thread: M22x1.5 Charging Pressure: 6bar
Cross Ref.	4750100130
Application	Iveco MAN 84521016011 Mercedes 0024291744
RL3531NB	
Ports: 1+2=M22x1.5 Delivered Pressure: 7.5bar	
Cross Ref.	4750100090
Application	DAF 1518928 Iveco 04676011 MAN 81521016057 Mercedes 0044290444
RL3531EA	
	Opening Prssure: 6.6bar Close Prssure: 5.9bar Ports: M20x1.5
Application	Mitsubishi MC802149
RL3531MA	
	Ports: 1+2=M16X1.5 Setting: 7.4 bar
Cross Ref.	4750150310
Application	Iveco 04780200

RL3531MA06	
Ports 1,2: M16x1.5 Delivered Pressure: (3.5 ± 0.2)bar	
Cross Ref.	4750150040
Application	DAF 1517895 Iveco 04457300 MAN 81521016153 Mercedes 0014316306
RL3531MA08	
Ports 1,2: M16x1.5 Delivered Pressure: (8.5 ± 0.15)bar	
Cross Ref.	4750150630
Application	DAF 1524015 Volvo 20382312
RL3531MA09	
Ports 1,2: M16x1.5 Delivered Pressure: (9.5 ± 0.15)bar	
RL3531MA24	
Ports 1,2: M16x1.5 Delivered Pressure: (7.4 ± 0.2)bar	
Cross Ref.	4750150010
Application	DAF 1505094 MAN 81521016150 Mercedes 0014315706

Pressure Limiting Valve		2.07
RL3531ZA		
	Ports: 1+2= M22X1.5 Setting: 6.0bar	
Cross Ref.	0481063004000	
Alternative	4341000240	
Application	DAF	0110444
	Iveco	02516827
	MAN	81521107011
	Mercedes	0004295544
RL3512MA03		
	Inlet Port1: M22x1.5 Outlet Port2: M22x1.5 Delivery Pressure: (10±0.3)bar	
Cross Ref.	4750103010	
Application	MAN	81521016270
RL3512MA04		
	Inlet Port1: M22x1.5 Outlet Port2: M22x1.5 Delivery Pressure: (5.3±0.3)bar	
Cross Ref.	4750103020	
Application	DAF	104249
	Scania	318158
	Mercedes	0014299044
RL3512MA05		
	Inlet Port 1: M22x1.5 Outlet Port 2: M22x1.5 Delivery Pressure: (1.8±0.3)bar	
Cross Ref.	4750103030	
Application	Schmitz	INSO 120011

	RL3512MA06	
	Inlet Port 1: M22x1.5 Outlet Port 2: M22x1.5 Delivery Pressure: (7.5±0.3)bar	
Cross Ref.	4750103040	
Application	Terex-Demag	00046112
RL3512MA07		
	Inlet Port 1: M22x1.5 Outlet Port 2: M22x1.5 Delivery Pressure: 6.0 ⁰ _{-0.3} bar	
Cross Ref.	4750103050	
Application	DAF	1518931
	Schmitz	50608
RL3512MA08		
	Inlet Port 1: M22x1.5 Outlet Port2 : M22x1.5 ⁰ _{-0.2} bar Delivery Pressure: 5.0 ⁰ _{-0.2} bar	
Cross Ref.	4750103060	
Application	Faun	99707006463
RL3512MA09		
	Inlet Port 1: M22x1.5 Outlet Port 2: M22x1.5 Delivery Pressure: 1.8 ^{+0.3} ₀ bar	
Cross Ref.	4750103070	
Application	MAN	84521016040
	BPW	02.431.09.60.0
	DAF	1503133
	Schmitz	050602
	Krone	58125050

Pressure Limiting Valve 2.07	
RL3512MA10	
	Inlet Port 1: M22x1.5 Outlet Port 2: M22x1.5 Delivery Pressure: 7.8 $^{+0.3}_0$ bar
	Cross Ref. 4750103080 Application Faun 99707766160 Krone 9454010 MAN , DAF
RL3512MA11	
	Inlet Port 1: M22x1.5 Outlet Port 2: M22x1.5 Delivery Pressure: 5.7 $^{+0.3}_0$ bar
	Cross Ref. 4750103090 Application Scania 411010 Mercedes 0014291744
RL3512MA12	
	Inlet Port 1: M22x1.5 Outlet Port 2: M22x1.5 Delivery Pressure: 4.0 $^{+0.3}_0$ bar
	Cross Ref. 4750103100 Application MAN, DAF
RL3512MA13	
	Inlet Port 1: M22x1.5 Outlet Port 2: M22x1.5 Delivery Pressure: 3.5 $^{+0.3}_0$ bar
	Cross Ref. 4750103110 Application Mercedes 0034294444 BPW 02.431.04.60.0 MAN 81521016084

RL3512MA14	
	Inlet Port 1: M22x1.5 Outlet Port 2: M22x1.5 Delivery Pressure: 5.5 $^{+0.2}_0$ bar
	Cross Ref. 4750103120 Application MAN 84521016039
RL3512MA15	
	Inlet Port 1: M22x1.5 Outlet Port 2: M22x1.5 Delivery Pressure: 3.3 $^{+0.3}_0$ bar
	Cross Ref. 4750103130 Application DAF 223439 Scania 295498 Iveco 04456618
RL3512MA16	
	Inlet Port 1: M22x1.5 Outlet Port 2: M22x1.5 Delivery Pressure: 1.4 $^{+0.3}_0$ bar
	Cross Ref. 4750103240 Application Mercedes 0034315106
RL3512MA17	
	Inlet Port 1: M22x1.5 Voss Outlet Port 2: M22x1.5 Delivery Pressure: 8.5 $^{0}_{-0.4}$ bar
	Cross Ref. 4750103000 Application MAN 81521016269

Pressure Limiting Valve		2.07
		
RL3512MA18		
	Inlet Port 1: M22x1.5 Outlet Port 2: M22x1.5 Delivery Pressure: (8.0 ± 0.2)bar	
Cross Ref.	4750102000	
Application	Scania	1356634
RL3512MA19		
	Inlet Port 1: M22x1.5 Voss Outlet Port 2: M22x1.5 Voss Delivery Pressure: (8.1-8.5)bar	
RL3512MA20		
	Inlet Port 1: M22x1.5 Voss Outlet Port 2: M22x1.5 Voss Delivery Pressure: (5.3-5.6)bar	
Cross Ref.	4750103150	
Application	MAN, DAF	
RL3512MA21		
	Inlet Port 1: M22x1.5 Voss Outlet Port 2: M22x1.5 Voss Delivery Pressure: (5.7-6.0)bar	
Cross Ref.	4750103160	
Application	MAN, DAF	
RL3512MA22		
	Inlet Port 1: M22x1.5 Voss Outlet Port 2: M22x1.5 Voss Delivery Pressure: (6.5-6.8)bar	
Cross Ref.	4750103170	
Application	DAF	1518116
	MAN	81521016282
	Mercedes	0054293244
		6994290844

RL3512MA23		
	Inlet Port 1: M22x1.5 Voss Outlet Port 2: M22x1.5 Voss Delivery Pressure: (7.8-8.0)bar	
Cross Ref.	4750103180	
Application	MAN	81521016282
	Mercedes	0044299644
	Neoplan	11017354
RL3512MA24		
	Inlet Port 1: M22x1.5 Voss Outlet Port 2: M22x1.5 Voss Delivery Pressure: (7.5-7.8)bar	
Cross Ref.	4750103190	
Application	MAN, DAF	
RL3512MA25		
	Inlet Port 1: M22x1.5 Voss Outlet Port 2: M22x1.5 Voss Delivery Pressure: (5.5-5.7)bar	
Cross Ref.	4750103200	
Application	MAN, DAF	
RL3512MA26		
	Inlet Port 1: M22x1.5 Voss Outlet Port 2: M22x1.5 Voss Delivery Pressure: (6.0-6.3)bar	
Cross Ref.	4750103210	
Application	MAN, DAF	

Pressure Limiting Valve 2.07	
RL3512MA27	
	Inlet Port 1: M22x1.5 Voss Outlet Port 2: M22x1.5 Voss Delivery Pressure: (4.2-4.4)bar
	Cross Ref. 4750103220 Application MAN, DAF
RL3512MA28	
	Inlet Port 1: M22x1.5 Voss Outlet Port 2: M22x1.5 Voss Delivery Pressure: (4.6-4.8)bar
	Cross Ref. 4750103230 Application MAN, DAF
RL3512MA29	
	Inlet Port 1: M22x1.5 Voss Outlet Port 2: M22x1.5 Voss Delivery Pressure: (3.5-3.8)bar
	Cross Ref. 4750103250 Application DAF 1518117 MAN 81521016282 Mercedes 0054290344
RL3512MA30	
	Inlet Port 1: M22x1.5 Voss Outlet Port 2: M22x1.5 Voss Delivery Pressure: (8.5-8.7)bar
	Cross Ref. 4750103260 Application MAN, DAF

RL3512MA31	
	Inlet Port 1: M22x1.5 Voss Outlet Port 2: M22x1.5 Voss Delivery Pressure: (2.5-2.8)bar
Cross Ref. 4750103280 Application MAN 81521016294	
RL3512MA32	
	Inlet Port 1: M22x1.5 Voss Outlet Port 2: M22x1.5 Voss Delivery Pressure: (5.0-5.2)bar
Cross Ref. 4750103290 Application MAN, DAF	
RL3512MA33	
	Inlet Port 1: M22x1.5 Voss Outlet Port 2: M22x1.5 Voss Delivery Pressure: (9.3 ± 0.3)bar
Cross Ref. 4750103330 Application MAN 81521016295 NATO 4820123702502	
RL3512MA34	
	Inlet Port 1: M22x1.5 Voss Outlet Port 2: M22x1.5 Voss Delivery Pressure: (6.5-6.8)bar
Cross Ref. 4750103300 Application Mercedes 0054293244 A0054293244	

Pressure Limiting Valve		2.07
RL3512MA35		
	Inlet Port 1: M22x1.5 Voss Outlet Port 2: M22x1.5 Voss Delivery Pressure: (7.8-8.0)bar	
Cross Ref.	4750103310	
Application	Mercedes	0044299644 A0044299644
RL3512MA36		
	Inlet Port 1: M22x1.5 Voss Outlet Port 2: M22x1.5 Voss Delivery Pressure: (3.5-3.8)bar	
Cross Ref.	4750103320	
Application	Mercedes	0054290344 A0054290344
RL3512MA37		
	Inlet Port 1: M22x1.5 Voss Outlet Port 2: M22x1.5 Voss Delivery Pressure: (2.2-2.5)bar	
Cross Ref.	4750103340	
Application	MAN, DAF	
RL3512MA38		
	Inlet Port 1: M22x1.5 Voss Outlet Port 2: M22x1.5 Voss Delivery Pressure: (8.1-8.5)bar	
Cross Ref.	4750103350	
Application	Mercedes	0054297444 A0054297444

RL3512MA39		
	Inlet Port 1: M22x1.5 Voss Outlet Port 2: M22x1.5 Voss Delivery Pressure: (10.0-10.2)bar	
Cross Ref.	4750103380	
Application	Mercedes	0054298444 A0054298444
RL3512MA40		
	Inlet Port 1: M22x1.5 Voss Outlet Port 2: M22x1.5 Voss Delivery Pressure: (8.1-8.5)bar	
Cross Ref.	4750103390	
Application	Mercedes	0054298544 A0054298544
RL3512MA		
	Setting: 8.2bar Ports: All M22X1.5 Voss	
Cross Ref.	4750104000	
Application	DAF	1305138
	MAN	81521016286

Pressure Protection Valve		2.08
RL3531UA01		
	Delivery: 1/4"NPT, 1/8"NPT Operating Pressure-Opens AT 65 psi Closes At 45 psi	
Cross Ref.	KN31000	
Application	American Truck	

Pressure Protection Valve 2.08	
RL3531UB01	
	Ports Thread NPT1/4 Opening Pressure: (510±20)kPa
	Cross Ref. 90554107 Application Truck

RL3531HC-A	
Setting: 70 psi Ports: 1+2=1/4"NPT	
Cross Ref. 288323 Application Trailer	

Pressure Protection Valve For PR-4 2.08	
RL3531HA	
	Setting: 100 psi Ports: 1+2=1/4"PT
	Cross Ref. 286500 Application Trailer
RL3531HA-A	
Setting: 100 psi Ports: 1+2=1/4"NPT	
Cross Ref. 286500 Application Trailer	
RL3531HC	
Setting: 70 psi Ports: 1+2=1/4"PT	
Cross Ref. 288323 Application Trailer	

Pressure Protection Valve 2.08	
RL3531HA06	
	All Ports Thread: NPT1/2 Opening Pressure: (500 ± 20)kPa
	Cross Ref. 103976N Application American Truck
RL3531XA01	
	Inlet: 1/4"NPT Outlet: 1/4"NPT Setting: 5bar
	Cross Ref. 140370 Application American Truck
RL3531XA02	
Inlet: NPT3/8 Outlet: NPT3/8 Cut-off Pressure: (4.7-5.0)bar	
Cross Ref. 140280 Application American Truck	

Pressure Protection Valve 2.08	
RL3531XA03	
	Inlet: NPT3/8 Outlet: NPT3/8 Cut-off Pressure: (4.0-4.2)bar
Cross Ref.	140270
Application	American Truck

Transmission Air Regulator 2.09	
RL3531YA01	
	Supply: 1/4"NPT Delivery: 1/8"NPT Not-adjustable-preset At: (54-58)psi
Cross Ref.	16743
Application	American Trailer



Pressure Switch 2.10	
RLD5-M022	
	
Cross Ref.	SL-4 228600
RLD5-M026	
	Remark: Pressure: 5.5bar
Cross Ref.	ILP-3 228750

RLD5-M027	
	Remark: 55-26 1/4"PT Cut-Off Pressure: 60psi
Cross Ref.	279416

RLD5-M018	
	Port: NPT3/8
Application	FAW CA151





RLD5-M040	
	Port: NPT3/8
Application	FAW CA151

RLD4-359F	
	Port: M16x1.5

Repair Kits	Kits P/N	Repair Kit For	Cross Ref.	Application
	RL3531VA01-9	RL3531VA01		
	RL3531WA01-9 RL3531WA02-9 RL3531WA04-9	RL3531WA01 RL3531WA02 RL3531WA04	4341000022	Scania 392234 RVI 5000560242 Volvo 6210724

Air Storage		3
Air Reservoir		3.01
Test Points		3.02
Manual Drain Valve		3.03
Automatic Drain Valve		3.04

Air Reservoir		3.01
	RL3513EA02 Tractor Chassis With Conventional Cab CA4158K2R5, Lifan Junma Volume: 5L	
Cross Ref.	3513300-1Q	
Application	Coal Delivery King	
	RL3513UA03 Total Length: 284mm Total Width: 209mm Port: 2x1/2NPT,3x1/4NPT Volume: 6.8L	
Cross Ref.	CA291	
	RL3513UA02 Total Length: 337.5mm Total Width: 209mm Port: 2x1/2NPT,4x1/4NPT Volume: 9.1L	
Cross Ref.	CA105D	
	RL3513UA01 Total Length: 525mm Total Width: 209mm Port: 3x1/2NPT,3x1/4NPT Volume: 14.8L	
Cross Ref.	CA105A	

	RL3513FA08 Dia: ϕ 235 Port: 2x3/4-14NPT Port: 2x1/2-14NPT Port: 1/4-18NPT Volume: 24L Color:Black
Cross Ref.	CA2518B
	RL3513FA23 Volume: 24L Dia: ϕ 235 Ports thread: 3/4-14NPT
	RL3513FA Ports: 2x1/2" NPT, 3x3/4"NPT, 1x1/4"NPT Dia: ϕ 245 Volume: 25L
	RL3513EG01 Ports: M22x1.5 Dia: ϕ 245 Volume: 30L Comment: Cylinder Center One Inter Port
Cross Ref.	BFC6120, 3513, 030
Application	Neoplan
	RL3513FA09 Dia: ϕ 330 Ports: 2x3/4-14NPT Ports: 2x1/2-14NPT Port: 1/4-18NPT Volume: 48L Color:Black
Cross Ref.	CA2528

Air Reservoir		3.01	
		RL3513FA24	
		Volume: 48L Dia: Φ 330 Ports thread: 3/4-14NPT	
		RL3513FB	
		Ports: 2x1/2"NPT, 4x3/4" NPT, 1x1/4"NPT Dia: Φ 345 Volume: 60L	
		RL3513FC	
		Ports: All Ports M22x1.5 Dia: Φ 313 Volume: 60L	
Cross Ref.	9500600030		
Application	DAF	1506421	
	NATO	2530233383704	
		RL3513FC-B	
		Ports: 4xM22x1.5 Dia: Φ 313 Volume: 50L	
		RL3513FH	
		Ports: 4xNPT3/4-14 Port: NPT1/4 Ports: 2xNPT1/2 Dia: Φ 350 Volume: 60L	
		RL3513WA01	
		Ports: All M22x1.5 Dia: Φ 396 Volume: 80L	
Cross Ref.	9500800020		
Alternative	VB3308		
Application	DAF	1506423	

Test Points-Female		3.02	
		RL3506AB	
	M16x1.6	Ports: M12x1.5 Hex: SW17	
Cross Ref.	4637031050, 4637031160		
Alternative	318036001		
Application	Volvo	526031314020	
	Mercedes	0004312031	
		RL3506FA	
		Ports: M18x1.5 Hex: SW24	
Cross Ref.	4637031070		
Application	Volvo	1082480	
	MAN	81981256037	
		RL3506FB	
		Ports: M16x1.5 Hex: SW22	
Cross Ref.	4637031120		
Application	Trailer		

Test Points-Male		3.02	
		RL3506AC	
	M16X1.5	Ports: 1/4"NPT Hex: SW22	

Test Points-Male 3.02

RL3506AD	
	Ports: M22x1.5 Hex: SW27
Cross Ref.	4637031000
Alternative	ZB1208, 32040709
Application	Volvo 1505035 DAF 0709671 Iveco 03423571

RL3506EA	
	Ports: 3/8" NPT Hex: SW17

Test Points-Female 3.02

RL3506FC	
	Ports: M22x1.5 Hex: SW27
Cross Ref.	4637031080
Alternative	ZB1225
Application	Volvo 526031314000

Air Line Filter Assy 3.03

RL3511MA01	
	Supply: 1/4"PT Delivery: 1/4"PT
Cross Ref.	A4041
Application	American Trailer

Air Line Filter Assy 3.03

RL3511MA02	
	Supply: 1/4"NPT Delivery: 1/4"NPT
Cross Ref.	A4041
Application	American Trailer

Manual Drain Valve 3.03

RL3513BB	
	Port: M22X1.5
Cross Ref.	9343000030
Alternative	EE1100, 315011011
Application	Scania 285903 Iveco 2520243



RL3513BB02	
	Max Operating Pressure: 15bar Port Thread: M22X1.5
Cross Ref.	9343000010
Application	Mercedes 0004320607 Scania 285903 Iveco 1260634

Manual Drain Valve 3.03

RL3513EE	
	Port : NPT1/4
Application	American Trailer



Manual Drain Valve		3.03
		RL3513ZA
		Ports: 1/4"NPT
Cross Ref.	LDV3662, MIR 12105	
Application	American Trailer	
		RL3513EA
		Ports: 1/2 " NPT
Application	HINO	44530-1030
		RL3536MA
		Installation Plate Hole: ϕ 11.5 Installation Plate Hole Distance: 40mm
Application	Mitsubishi	MC803504
		RL3513YA
		Port: M14x1.5
Application	Nissan	47502-Z2000





Automatic Drain Valve		3.04
		RL3536NA
		Port 1,4: M12x1.5
		RL3513GC
		Ports: 1=M22x1.5 Male, 4=M12x1.5
Cross Ref.	EE4106	
Alternative	9343010000	
Application	RVI	5000791040
	Mercedes, Iveco Ikarbus, TAM, SANOS	

DV-2 Automatic Drain Valve		3.04
		RL3513LA
		Ports: Port 1/4"NPT Port 3/8"NPT Blocked
Cross Ref.	281923	
Application	American Trailer	
		RL3513LB
		Port: 1/4"NPT
Application	American Trailer	

Automatic Drain Valve		3.04
RL3536ZA01		
	Port: NPT1/4, NPT3/8 DC: 12V	
Cross Ref.	KN24001	
RL3536ZA02		
	Port: NPT1/4, NPT3/8	
Cross Ref.	KN24000	



Conventional Brake Control		4
Foot Brake Valve		4.01
Dual Brake Valve		4.02
Parking Brake Valve		4.03
P.T.O Shift Valve Assy.		4.04
Control Valve		4.05
LSV Relay, Mech Controlled		4.06
LSV Relay, Pneu.Controlled		4.07
LSV Relay, Emergency Valve		4.08
Spring Box		4.09
Quick Release Valve		4.10
Trailer Control Valve		4.11
Trailer Protection Valve		4.12
Tractor Protection Valve		4.13
Sealco Ratio Relay Valve		4.14
Trailer Spring Relay Valve		4.15
Trailer Spring Brake Valve		4.16
Relay Emergency Valve		4.17
Release Valve		4.18
Anti-Compound Valve		4.19
Relay Valve		4.20

Foot Brake Valve		4.01
		RL3514AF
	All Ports: NPT3/8 Angle: 39°	
Cross Ref.	3514010-K1H	
Application	FAW	
Repair Kit	RL3514AF-9	
		RL3514AG
	Ports: 11+12/21+22=NPT3/8 Angle: 45°	
Application	FAW	





		RL3514DA-F
	Ports 11,12,21,22: M16x1.5 Ports 13,23: M12 X1.5 Pred.: 0.3bar P23 Del: 3.0bar Angle: 45°	
Cross Ref.	4613240100	
Application	DAF	0375193
Repair Kit	RL3514DA-F-9	
		RL3514DA-G
	Ports 11,12,21,22: M16x1.5 Ports 13,23: M12x1.5 Pred.: 0.3bar P23 Del: 3.2bar Angle: 30°	
Cross Ref.	4613240160	
Application	DAF	1517913
	Volvo	1137213
Repair Kit	RL3514DA-G-9	
		RL3514DA-R
	Ports: M16x1.5-6H All/Ret=M12x1.5-6H	
Cross Ref.	4613245200	
Application	Volvo	1695943
	DAF	0691640
	Iveco	500002558
	MAN	81521616205
		RL3514DD
	Ports: Supp & Del Ports=M16x1.5, 4=M12x1.5 Pred.: 0.4bar, Ratio: 1.5:1	
Cross Ref.	4613190080	
Alternative	MB4650	
Application	DAF	1518067
	Mercedes	0024310605
Repair Kit	RL3514DD-9	





Foot Brake Valve		4.01
RL3514DG		
	All Ports: M16x1.5 Pred.: 0.3bar, Angle: 30°	
RL3514DG-A		
All Ports: M16x1.5 Pred.: 0.3bar Angle: 45°		
Cross Ref.	4613170240	
Alternative	MB4730	
Application	Mercedes	024311505
	Neoplan	11018632
RL3514DV		
	Ports: 11,12,21,22=M16x1.5 Other Ports=M12x1.5 Pred.: 0.3bar Angle: 30°	
Cross Ref.	4613170080	
Application	Goldhofer	250044
RL3514DX		
All Ports: M16x1.5 Pred.: 0.3bar Angle: 35°		
Cross Ref.	4613170020	
Application	Terex-Demag	63527940
RL3514DX-D		
Ports: 11,12,21,22=M16x1.5 Other Ports=M12x1.5 Pred.: 0.3bar Angle: 35°		
Cross Ref.	4613170000	
Application	DAF	1506089

RL3514DS		
	Pred.: 0.3bar All Ports: M16x1.5	
Cross Ref.	4613150080	
Alternative	320023001	
Application	DAF	1518060
	Iveco	04783981
	MAN	85500014354
	Mercedes	0014318305
	Scania	1314047
RL3514DS-D		
Ports 11,12,21,22: M16x1.5 Other Ports: M12x1.5 Pred.: 0.3bar		
Cross Ref.	4613150040	
Application	Mercedes	0024315405
Repair Kit	RL3514DS-D-9	
RL3514DS-E		
Ports 11,12: M12x1.5 Other Ports: M16x1.5		
Cross Ref.	4613150420	
Application	DAF	1506783
	Volvo	1613328
Repair Kit	RL3514DS-F-9	
RL3514DS-F		
Pred.: 0.3bar Ports 11,12,21,22: M16x1.5 Other Ports: M22x1.5		
Cross Ref.	4613150530	
Application	Mercedes	0034317305





Foot Brake Valve		4.01
RL3514DX-D01		
	Ports 11,12,21,22: M16x1.5 Other Ports: M12x1.5 Pred: 0.3bar	
RL3514DX-D03		
	Port: M16x1.5 Pred: 0.3bar Comment: 2xM12x1.5 Gaug Ports	
Cross Ref. Application Repair Kit	4613151560 Ford 2C45, 2A270AD RL3514DX-D09	
RL3514DX-D41		
	Ports 11,12: M12x1.5 Pred: 0.3bar Other Ports: M16x1.5	
Cross Ref. Application	4613151570 Ford	
RL3514HB21		
	Ports 11,12: M12x1.5 Other Ports: M16x1.5 DC:5V	
Cross Ref. Application	DX80E Scania 3 Series Bus 492273 Optare Versa, Tempo	

RL3514HB23		
	Ports: M16x1.5, M12x1.5	
Cross Ref. Application	DX80D Scania 4 Series Bus 469052	
RL3514DX-D05		
	Gauge Port 11,12: M12x1.5 Other Ports: M16x1.5 Pedal Angle: 45° DC: 24V	
Cross Ref. Application	4613180490 DAF 1518794 Iveco 04775057 Neoplan 1102407543908	
RL3514DX-D06		
	All Ports: M16x1.5 Pedal Angle: 43° Working Voltage: (8-32)V	
Cross Ref. Application	4613186040 DAF, Volvo 70313310 KingLong 35XG1-14020	
RL3514DX-D39		
	All Ports thread: M16x1.5, M12x1.5 Installation hole: $\phi 9$ DC 24V	
Cross Ref. Application	4613180470 DAF 1518793	

Foot Brake Valve		4.01
	RL3514DX-D18	
	Ports 11,12,21,22: M16x1.5 Installation Holes: 4xφ9 Pred: 0.3bar	
	RL3514DX-D22	
	All Ports: M16x1.5 Installation Holes: 4xφ9 Pred: 0.3bar	
Cross Ref.	4613150400	
Application	Mercedes	3454317105
	RL3514DX-D35	
	Ports 11,12: NPT1/4 Other Ports: M16x1.5 Pred: 0.3bar	
Cross Ref.	4613150570	
Application	VW, Ford	B1618
	RL3514DX-D40	
	All Ports thread: M16x1.5, M12x1.5 Installation hole: φ9 Ratio: 1:5:1	
	RL3514DX-D48	
	Ports 11,12,21,22: M16x1.5 Port 4: M12x1.5 Installation Holes: φ4X8.5 Pred: 0.4bar Ratio: 1:5:1	



	RL3514DY	
	Ports: 11+12/21+22=M16x1.5 Pred.: 0.3bar Angle: 25°	
Cross Ref.	4613170510	
Application	Evobus	8285434000
	RL3514EA	
	Pred: 0.4bar All Ports: M22x1.5 Voss	
Cross Ref.	4613152580	
Alternative	320049001, MB4647	
Application	DAF	1518064
	Mercedes	0034311505
Repair Kit	RL3514EA-9	
	RL3514EA-A	
	Pred.: 0.4bar All Ports: M22x1.5 Voss	
Cross Ref.	4613152610	
Application	DAF	1504968
	Mercedes	0044312005
	RL3514EA01	
	All Ports: M22x1.5 Voss Installation Holes: 4xM8	
Cross Ref.	4613152670	
Application	HOWO, CNHTC	

Foot Brake Valve		4.01	
		RL3514EA03	
		Ports 11, 21: $\phi 15 \pm 0.05$ Port 4: $\phi 10$ Ratio: 2:1 Pread: 0.4bar	
Cross Ref.	4613192740		
Application	Mercedes	0044314905	0044316205
		RL3514EA04	
		Ports: All Ports M22x1.5 Voss Pread.: 0.4bar	
Cross Ref.	4613152480		
Application	Mercedes	6954317405	
		RL3514ED	
		Ports: 11,12,21,22 M22x1.5 Voss Port4: M16x1.5 Voss Ratio: 2:1	
Cross Ref.	4613192700, 0481064206000		
Application	DAF	1518803	
	Mercedes	0024317105	
		RL3514EB-B	
		Pread.: 0.4bar Ratio: 1.5:1 Ports: 11,12,21,22=M22x1.5 Voss Port 4=M16x1.5 Voss	
Cross Ref.	4613192600		
Alternative	320038011, MB4653		
Application	DAF	1506092	
	Mercedes	0024317005	
Repair Kit	RL3514EB-B-9		

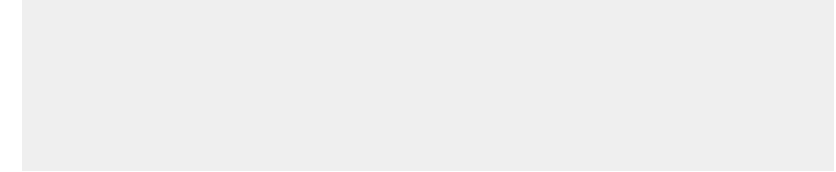
		RL3514EB	
		Pred.: 0.4bar , Ratio: 2:1 Ports: 11,12, 21,22=M22x1.5 Voss Port 4=M16x1.5 Voss	
Cross Ref.	4613192710		
Alternative	320050011, MB4657		
Application	DAF	1518070	
	Mercedes	0034311705	
Repair Kit	RL3514EB-9		
		RL3514EB-A	
		Ports: 11,12, 21,22=M22x1.5 Voss Port 4=M16x1.5 Voss Pread.: 0.4bar , Ratio: 1.25:1	
Cross Ref.	4613192500		
Alternative	320050031, MB4661		
Application	DAF	1518069	
	Mercedes	0034316305	
Repair Kit	RL3514EB-A-9		
		RL3514EB01	
		Ports: 11,12, 21,22=M22x1.5 Voss Port 4=M16x1.5 Voss Ratio: 1.5:1, Pread: 0.3bar	
Cross Ref.	4613192620		
Application	Mercedes	0044310205	
		RL3514EC	
		All Ports: $\phi 15 \pm 0.05$ Comment: Silencer Fitted Pread.: 0.5bar	
Cross Ref.	4613152640		
Application	DAF	1518065	
	Mercedes	0044314605	
Repair Kit	RL3514EC-9		



Foot Brake Valve		4.01
RL3514MA		
 <p>Ports: All M22x1.5 Predominance: 0.25bar Fixed Comment: Pedal Angle 35°</p>		
Cross Ref.	4613072000	
Alternative	320009012	
Application	Volvo	6231643
	DAF	1506081
	MAN	88523206230
	Mercedes	0014313805
RL3514MC		
<p>Ports: All M16x1.5 Predominance: 0.25bar Fixed Comment: Pedal Angle 35°</p>		
RL3514MB		
 <p>Ports: All M22x1.5 Predominance: 0.25bar Fixed</p>		
Cross Ref.	4613074790	
Alternative	MB4711	
Application	Volvo	1696150
Repair Kits	RL3514MB-9	
RL3514MD		
<p>Ports: All M16x1.5 Predominance: 0.25bar Fixed</p>		
Cross Ref.	4613074390	
Application	DAF	1518057
	Mercedes	0014319305
Repair Kits	RL3514MD-9	

RL3514ME		
 <p>Ports: All Ports M22x1.5 Pred.: 0.25bar Stroke: 31mm</p>		
Application	Iveco DAF Mercedes	
Repair Kits	RL3514ME-9	
RL3514ME11		
 <p>All Ports: M22x1.5, Pred: 0.25bar Stroke: 31mm</p>		
Cross Ref.	4614911020	
Application	DAF	1518073
	Iveco	02470415
	Mercedes	0004319405
RL3514MH		
 <p>All Ports: M22x1.5 Stroke: 32mm</p>		
Cross Ref.	4612951000, 4612951010	
Application	Mercedes	0004319005 A0004319005

Foot Brake Valve		4.01	
		RL3514MF	
		Pred.: 0.25bar All Ports: M16x1.5	
Cross Ref.	4700120000		
Application	DAF	1518099	
	Mercedes	0014313505	
Repair Kits	RL3514MF-9		
		RL3514CA	
		Ports: M22x1.5 Other Ports: M16x1.5	
Cross Ref.	MB4434		
Alternative	4613130500		
Application	MAN	81523206030	
Repair Kits	RL3514CA-9		
		RL3514CC	
		Ports: M22x1.5 Other Ports: M18x1.5	
		RL3514CB	
		All Ports: M18x1.5 Pred: 0.3bar	
Cross Ref.	1023275000		
Alternative	4613230400		
Application	RVI	24817040	
		5000249536	
		0024817042	
Repair Kits	RL3514CB-9		

Dual Brake Valve		4.02	
		RL3514GA	
		Angle: 45° All Ports: NPT3/8	
Repair Kits	RL3514GA-9		
		RL3514GC	
		Angle: 45° All Ports: NPT3/8	
Application	Universal E6, TATA		
Repair Kits	RL3514GC-9		
		RL3514GD03	
		Ports 11,12: NPT1/4 Other Ports: NPT3/8	
Cross Ref.	104309		
Application	American		
		RL3514GD25	
		All Ports: NPT3/8 Installation Holes: 6x5/16-18UNC	

Dual Foot Brake Valve 4.02	
	<p>RL3514GD28</p> <p>Sup Ports 1,2: M10x1,M16x1.5 Del Port 13: M16x1.5 Del Port 23: M18x1.5 Installation Holes: M10x1.5</p>
	<p>RL3514GM</p> <p>All Ports: NPT3/8</p>

	<p>RL3514GE</p> <p>All Ports: RC NPT3/8</p>
---	--

E-6 Dual Brake Valve 4.02	
	<p>RL3514GD-A</p> <p>All Ports: NPT3/8 Installation: 5/16-18 UNC</p>
	<p>Cross Ref. 286171, 9618800010 Application American Repair Kits RL3514GD-9</p>
	<p>RL3514GD</p> <p>All Ports: NPT3/8 Installation: M8</p>
<p>Application American</p>	

E-3 Dual Brake Valve 4.02	
	<p>RL3514PA</p> <p>Ports: Supply & Delivery NPT1/2 Auxiliary Sup NPT1/4 Installation: 3xM8</p>
	<p>Application American Repair Kits RL3514PA-9</p>
<p>Cross Ref. 277863 Application American</p>	<p>RL3514PA-A</p> <p>Ports: Supply & Delivery NPT1/2 Auxiliary Sup NPT1/4 Installation: 3xUNC 5/16-18</p>





E-10 Dual Brake Valve 4.02	
	<p>RL3514GD02</p> <p>All Ports: NPT3/8 Installation Thread: 5/16-18 UNC</p>
	<p>Cross Ref. 101100 Application American</p>

	<p>RL3514PB</p> <p>Supply Ports: NPT1/4, NPT1/2 Delivery Ports: NPT1/2 Angle: 34°</p>
	<p>Application American</p>

E-5 Foot Brake Valve		4.01
		RL3514LA
	Supply Port: NPT1/4, NPT1/2 Delivery Port: NPT1/2, NPT1/4, NPT3/8 Installation: 3/8-24UNF	
Cross Ref.	279950	
Alternative Application	9730021150, 9730020130 Scania 111, 81	
		RL3514LA01
	Port 1: RC3/8 Port 2: RC1/4 Installation: 5/16NC	
Application	APSA 4474	

Foot Brake Valve		4.01
		RL3514YA01
	All Ports: NPT3/8 Installation Holes: 5/16-18UNC	
Cross Ref.	800629	
Application	American	
		RL3514HA
	All Ports: M16x1.5, Pred.: 0.3bar	
Cross Ref.	MB4629	
Application	Mercedes 0014318305 0014318905 0014319905 Scania 1314047 Volvo 6996123 DAF 68409 Iveco 04783981	
Repair Kits	RL3514HA-9	

		RL3514HB
	All Ports: M16x1.5 Pred.: 0.3bar	
Cross Ref.	MB4630	
Alternative Application	4613150080 Mercedes, BMC, Fallonloo, Daewoo, Alia	
Repair Kits	RL3514HB-9	
		RL3514HB17
	All Ports: M16x1.5 Pred: 0.4bar	
Cross Ref.	MB4611	
Application	RVI 5000791199	
		RL3514HB18
	All Ports: M16x1.5 Pred: 0.15bar	
Cross Ref.	MB4613	
Application	RVI Trucks Magnum Premium, G340 5001829060	
		RL3514HB22
	All Ports: M16x1.5 Pred: 0.2bar	
Cross Ref.	MB4852	
Application	Truck	

Foot Brake Valve		4.01	
		RL3514HC	
		Ports: M22x1.5 Voss Pred.: 0.3bar	
Cross Ref.	MB4694		
Application	DAF	1209116	1337184
		RL3514HC-A	
		All Ports: M22x1.5 Voss Pred.: 0.3bar	
		RL3514HD	
		Ports: M12x1.5 Other Ports: M16x1.5 Pred.: 0.2bar	
Cross Ref.	MB4690		
Application	Volvo	1628491	20568396
		RL3514HG	
		Ports: M12x1.5 Other Ports: M16x1.5	
Cross Ref.	DX70C		
Alternative	4613150080		
Application	Mercedes	0014318305	
	Iveco	04783981	
	Scania	1314047	
	Volvo	6996123	
Repair Kits	RL3514HG-9		



		RL3514HE	
		All Ports: M16x1.5 Pred: 0.3bar, DC: 24V	
Cross Ref.	DX75BA		
Application	Iveco	500317963	
Repair Kits	RL3514HE-9		
		RL3514HH	
		All Ports: M16x1.5 Pred.: 0.3bar	
Cross Ref.	MB4636		
Alternative	4613150090		
Application	DAF	0385759	
		RL3514HE-A	
		All Ports: M16x1.5 Pred: 0.3bar, DC: 24V	
Cross Ref.	DX75BAY		
Application	Iveco	500382823	
Repair Kits	RL3514HE-A-9		
		RL3514HE-B	
		All Ports: M16x1.5 Ratio: 3:1 Pred: 0.3bar, DC: 24V	
Cross Ref.	DX95B		
Application	Iveco	99435645	
Repair Kits	RL3514HE-B-9		

Foot Brake Valve		4.01
	RL3514HE13	
	All Ports: M16x1.5 Ratio: 3:1 Pred: 0.3bar, DC: 24V	
Application	Iveco	500382824
	RL3514JA01	
	Supply Ports: NPT1/2, NPT1/4 Delivery Ports: NPT1/2, NPT1/4	
Cross Ref.	286773	
Application	Dodge-Inter	
	RL3514JA02	
	Supply Ports: NPT1/2, NPT1/4, NPT3/8 Delivery Ports: NPT1/2, NPT3/8	
Cross Ref.	101818	
Alternative	9618801000	
Application	NVA	464904C91
	RL3514JA03	
	Supply Ports: NPT1/2, NPT1/4 Delivery Ports: NPT1/2, NPT1/4 Installation Holes: 3x5/16-18UNC-2B	
Cross Ref.	288383	
Alternative	9618801030	
	RL3514XA01	
	Inlet Port 11,12: M22x1.5 Voss Outlet Port 21,22: M22x1.5 Voss Control Port 4: M16x1.5 Voss Pred: 0.3bar	
Cross Ref.	MB4815, I136302	
Application	MAN	81521306148

	RL3514XA03	
	All Ports: M22x1.5	
Cross Ref.	MB4821	
Application	MAN	81521306219
	RL3514XA04	
	Inlet Port 11, 12: M22x1.5-6H Outlet Port 21, 22: M22x1.5-6H Control Port 4: M16x1.5-6H Pred: 0.3bar	
Cross Ref.	MB4820	
Application	MAN	81521306222
	RL3514XD01	
	Port Thread: ϕ 12	
Cross Ref.	4614945020	
Application	DAF	1518075
	RVI	5010260033
	RL3514XD05	
	Inlet Port And Outlet Port Thread: M16x1.5 Exhaust Port Thread: M22x1.5	
Cross Ref.	4613150890	
Application	MAN	81521306124
		81521306129
		81521306130

Foot Brake Valve		4.01
RL3514NA		
	Angle: 45° Ports: 11+12=3/8" NPT, 21+22=1/4" NPT	
Repair Kits	RL3514NA-9	
RL3514NB		
	Angle: 28° All Ports: RC3/8"	
Application	HINO	47160-2452
Repair Kits	RL3514NB-9	
RL3514SA		
	Port Thread: $\phi 12$	
Cross Ref.	0481064603000	
Alternative	4613151800	
Application	DAF	1504971
	Scania	1324662
RL3514DX-D30		
	Ports 11,12: M12x1.5, $\phi 10, \phi 15$ Ports 21,22: M14x1.5, $\phi 15$ Pred: 0.1bar	
Cross Ref.	M600920,263243700109	
Application	India Truck	









RL3514DX-D31	
	Port 11,12: M12x1.5, M16x1.5 Port 21,22: M14x1.5, M16x1.5 Pred: 0.3bar
Cross Ref.	8300310, M600960
Application	India Truck
RL3514DX-D32	
	Ports 11,12: M12X1.5, $\phi 10, \phi 15$ Ports 21,22: $\phi 15$
Cross Ref.	M600900
Application	India Truck
RL3514DX-D33	
	Ports 11,12: M12x1.5, M16x1.5 Ports 21,22: M14x1.5, M16x1.5 Pred: 0.1bar
Cross Ref.	M601010
Application	India Truck
RL3514XC01	
	Ports 11,12: M12x1.5, $\phi 10$ Ports 21,22: M14x1.5, $\phi 15$ Angle: $(45 \pm 2)^\circ$ Pred: 0.3bar
Cross Ref.	263243700163
Application	India Truck

Foot Brake Valve		4.01
RL3514DA		
	All Ports: M16x1.5 Pred: 0.3bar	
Cross Ref.	FS815359X0004	
RL3514DW		
	Inlet Port 11,12: M16x1.5-6H Outlet Port 21,22: M16x1.5-6H Gauge Port 11,12: M12x1.5-6H	
Cross Ref.	1417035500003	
Application	Foton Auman 6 Series Root Van (BJ1317vnpjj-19) Foton Auman Dump (BJ3258dlpjb-19) Rowor III -140, III -190	
RL3514DS-H		
	All Ports: NPT3/8 Pred: 0.3bar	
Application	FAW Anhui New Horse	
RL3514DX-D02		
	Inlet Port 11,12: M16x1.5 Outlet Port 21,22: M16x1.5 Pred: 0.3bar	
Cross Ref.	1104335900027	
Application	Foton Ollin	

RL3514DX-D11	
	Angle: 45° Ports 11,12,21,22: M16x1.5 Pred: 0.3bar
Application	XiaMen King Long
RL3514DX-D13	
	Ports 11,12,21,22: M16x1.5 Pred: 0.1bar
Cross Ref.	35TAA-14020
Application	SuZhou King Long
RL3514DX-D34	
	Ports 11,12: M16x1.5, M12x1.5 Ports 21,22: M16x1.5 Pred: 0.3bar
Cross Ref.	WG9000360005/1
Application	CNHTC Howo
RL3514DX-D85	
	Ports 11,12,21,22: M16x1.5 Pred: 0.3bar Angle: 45°
Application	XiaMen King Long

Foot Brake Valve		4.01
RL3514DX-D96		
	<p>Ports 11,12,21,22: M16x1.5 Installation Holes: M8</p>	
<p>Cross Ref. 35GC2-14020 Application SuZhou King Long</p>		
RL3514ME10		
	<p>Ports 11,12,21,22: 6xM16x1.5</p>	
<p>Application XiaMen King Long</p>		



Repair Kits	Kits P/N	Repair Kits For	Cross Ref.	Application
	RL3514AF-9	RL3514AF		
	RL3514DA-F-9 RL3514DA-G-9	RL3514DA-F RL3514DA-G	4613150052	RVI 5000821899 Volvo 270969 MAN 81521306104 Iveco 42493947 Mercedes 0014300460
	RL3514DD-9	RL3514DD	4613190072	DAF 1518800 Dimetal 4047636
	RL3514DS-9 RL3514DS-D-9 RL3514DS-F-9	RL3514DS RL3514DS-D RL3514DS-F	4613159002	Mercedes 0004302706 Volvo 270890
	RL3514DX-D09	RL3514DX-D	4613159282	
	RL3514EA-9	RL3514EA	4613159202	Mercedes 0004308106
	RL3514EB-9 RL3514EB-A-9 RL3514EB-B-9	RL3514EB RL3514EB-A RL3514EB-B	4613190022	Mercedes 0014300660
	RL3514EC-9	RL3514EC	4613159142	Mercedes 0004306906
	RL3514CB-9	RL3514CB	SEB22267	Irisbus Renault Trucks

Repair Kits	Kits P/N	Repair Kits For	Cross Ref.	Application
	RL3514MA-9 RL3514MB-9 RL3514MC-9 RL3514MD-9 RL3514ME-9 RL3514MF-9	RL3514MA RL3514MB RL3514MC RL3514MD RL3514ME RL3514MF	4613070022	Scania 638771 Volvo 272572
	RL3514CA-9	RL3514CA RL3514CC	172375	
	RL3514GA-9 RL3514GC-9	RL3514GA RL3514GC		
	RL3514GD-9	RL3514GD	289335	American
	RL3514PA-9	RL3514PA	289329	American
	RL3514HA-9 RL3514HB-9	RL3514HA RL3514HB	183121	Mercedes
	RL3514HG-9	RL3514HG		
	RL3514HE-9 RL3514HE-A-9 RL3514HE-B-9	RL3514HE RL3514HE-A RL3514HE-B	076620102000	
	RL3514NA-9 RL3514NB-9	RL3514NA RL3514NB		

Parking Brake Valve		4.03
	RL3526AK	
	Ports 1,2 = M14X1.5	
Cross Ref.	9617221510	
Alternative	HB1203, 325017001	
Application	Iveco	101741
Repair Kits	RL3526AK-9	
	RL3526AK01	
	Ports: 1,2=M14X1.5	
Cross Ref.	9617221820	
Application	Mercedes	3844307309
	RL3526BK	
	Ports: 1,2=M14x1.5	
Application	Scania	436190
Alternative	HB1180, 9617221500	
Repair Kits	RL3526BK-9	
	RL3526BK-B	
	Ports 1, 2 thread: M14x1.5 Installation hole thread: M8	
Cross Ref.	9617221600	
Application	DAF	0664867





	RL3526BA	
	Ports 1, 2= M16X1.5 Parker	
Application	Foton	1315035300005
	Suzhou King Long	35GC2-26010
Repair Kits	RL3526BK-9	
	RL3526BA01	
	Port 1: M16x1.5 Port 2: M16x1.5 Mounting: M6	
Cross Ref.	9617230210	
Application	Scania	469271
	RL3526BA04	
	Ports 1,2=M16x1.5 Exhaust Hole: $\Phi 6$ Installation Hole: M6 Installation Hole Spacing: (80 \pm 0.2)mm	
Application	CNHTC	WG9719360030/2
	RL3526BA07	
	Ports 1,2=M16x1.5	
Cross Ref.	9617230040	
Application	DAF	1505331
	Volvo	6702610

Parking Brake Valve		4.03	
		RL3526BA03	
		Ports 1,2: M16x1.5	
Cross Ref.	9617230380		
Application	Foton	1315035300005	
	DWCV	3454402520	
		RL3526BA10	
		Ports Thread 2xM16x1.5 Installation Hole Thread: M6	
Application	Kamaz		
		RL3526BA14	
		Ports 1, 2 Thread: M16x1.5 Installation Hole: M6, DC Max 24V	
Cross Ref.	9617230640		
Application	Kamaz		
		RL3526BB	
		Ports: 1, 2=M16x1.5 Parker	
Cross Ref.	9617230010		
Application	DAF	0371274	
	Iveco	500002949	
	MAN	M225975	
Repair Kits	RL3526BB-9		





		RL3526BK01	
		Ports 1, 2: M14x1.5-6H Installation hole: 2xM6-6H Parking position: 73 °	
Cross Ref.	8845021050		
Application	Foton		
		RL3526BA02	
		Inlet Port 11: M18x1.5-6g Outlet Port 21: M18x1.5-6g Installation Plate Hole: M6 Parking Position: 73 °	
Cross Ref.	13062353M0055		
Application	Foton Rowor II Foton Rowor III -140 Foton Rowor I Foton Rowor III -190		
		RL3526BA09	
		Port 1: φ10 Port 21: φ10	
Cross Ref.	3508915-240		
Application	FAW		
		RL3526BA08	
		Ports 1,2=M16x1.5 Installation Hole: M6 Installation Hole Spacing: 80mm	
Cross Ref.	XMQ6112E2-3526010		
Application	XiaMen King Long		



Parking Brake Valve		4.03	
		RL3526BA13	
		Ports 1, 2: M16x1.5 Installation hole: 2xM6 Parking position 73°	
Cross Ref.		3506900LE170	
Application		JAC LCV III	
		RL3526BM	
		Inlet Port 1: NPT3/8 Outlet Port 2: NPT3/8 Installation Plate Hole: ϕ 7 Parking Position: 85°	
Cross Ref.		13053357X0007	
Application		Foton Rowor P140	
		RL3526CK	
		Ports 11,21,22: M14x1.5	
Cross Ref.		9617222520	
Alternative		HB1201, 328019001	
Application		Iveco	228235
		DAF	374642
		Mercedes	0014300281
Repair Kits		RL3526CK-9	
		RL3526CK02	
		Ports 11,21,22=M14x1.5 Exhaust Hole: ϕ 8.5 Installation Hole: M8 Installation Hole Spacing: 40mm	
		RL3526CK05	
		Ports 1,21,22: M14x1.5	
Cross Ref.		9617223140	
Application		Scania	390286





		RL3526CK03	
		Ports 11,12: M14x1.5 Ports 21,23: M14x1.5 Mounting: M8x1.25 Parking Position: 73°	
Cross Ref.		9617222840	
Application		Mercedes	3644307181
		RL3526CK04	
		Ports 11, 21: M14x1.5-6H Installation hole: 2xM8x1.25-6H	
Cross Ref.		9617222750	
Application		Mercedes	0024302481
		DAF	
		RL3526CK06	
		Ports 11,21,22=M14x1.5 Exhaust Hole: ϕ 8.5 Installation Hole: M8 Installation Hole Spacing: (40 \pm 0.15)mm	
Cross Ref.		9617223150	
Application		Mercedes	3884307709
		RL3526CK37	
		Ports 11, 21, 22: M14x1.5-6H Installation Hole: 2xM6-6H Installation Hole Spacing: 80mm Parking Position 85°	
Cross Ref.		9617223050	
Application		NATO	
		Volvo	1598586





Parking Brake Valve		4.03	
	RL3526CK116		
	Ports 11,21: M14x1.5		
Cross Ref.	961 722 264 0		
Application	Daimler Chrysler AG RVI Trucks SAS		
	RL3526RA		
	Ports: Slide Lock		
Cross Ref.	9617222120		
Alternative	HB1173		
Application	DAF	1518221	
	Mercedes	0004309581	
Repair Kits	RL3526RA-9		
	RL3526RB		
	Ports: Slide Lock		
Cross Ref.	9617222320		
Alternative	HB1168		
Application	DAF	1524289	
	Mercedes	0004309681	
Repair Kits	3526 010 001 9-1		
	RL3526EK		
	Ports 11,21,22: M14x1.5		
Cross Ref.	9617222580		
Alternative	HB1179		
Application	MAN	112232900	
	Iveco	4841086	
Repair Kits	RL3526EK-9		





	RL3526DC		
	Ports 11,21,22=M16x1.5 Installation Hole: M6 Installation Hole Spacing: 80mm		
Cross Ref.	9617231020		
Application	DAF	1518234	
	Iveco	980942	
	MAN	99100360455	
	RVI	5010056094	
	RL3526DC05		
	Ports 1, 21, 22: M16x1.5-6H Installation hole: 2xφ7 Parking position 73°		
Cross Ref.	9617232130		
Application	DAF	1505339	
	RL3526DC06		
	Ports 1, 21, 22 thread: M16x1.5 Installation hole: M6		
Cross Ref.	9617231570		
Application	KAMAZ		
	RL3526DD		
	Ports: 1,21,22 M16x1.5		
Application	FAW		





Parking Brake Valve		4.03
RL3526DE		
	Ports 1,21,22: All M16x1.5	
Application	FAW	3508815-Q109C
RL3526DX		
	Ports 1, 21, 22: M16x1.5 Parker	
Alternative	HB1500	
Application	DAF	81523156113
	MAN	
Repair Kits	RL3526DX-9	
RL3526DY		
	Ports 1, 21, 22: M16x1.5 Parker	
Cross Ref.	9617231080	
Application	DAF	0559817
Repair Kits	RL3526DY-9	
RL3526DX05		
	Port1: M16x1.5 Port21: M16x1.5 Port22: M16x1.5 Mounting: M6	





RL3526DX07		
	Break 73 Voss Push In Fitting	
Cross Ref.	9617231000	
Application	DAF	1518233
	MAN	81523156113
	NATO	2530123122719
RL3526DX03		
	Port 1,21,22: M16x1.5	
Cross Ref.	9617231110	
Application	DAF	1518236
	MAN	85500014558
RL3526DX06		
Ports: 1,21,22 M16x1.5		
Cross Ref.	9617232080	
Application	DAF	1519269
	Iveco	5010145720
	RVI	5010145720
RL3526DX08		
Ports thread 3xM16x1.5 Installation hole thread: M6		
Application	Kamaz	

Parking Brake Valve		4.03	
		RL3526NA	
		Ports: 2xM16x1.5 Voss	
Cross Ref.	9617230190		
Application	DAF	1524310	
	MAN	81523155160	
Repair Kits	RL3526NA-9		
		RL3526NB	
		Ports: 3xM16x1.5 Voss	
Cross Ref.	9617231040		
Alternative	HB1510		
Application	DAF	1518235	
	Mercedes	0024307581	
Repair Kits	RL3526NB-9		
		RL3526NA-B	
		Port1: M16x1.5 Voss Port21: M16x1.5 Voss Mounting: M8	
Cross Ref.	9617230050		
Alternative	HB1511		
Application	DAF	1518229	
	Mercedes	0024307481	
		RL3526NA-C	
		Ports: 3xM16x1.5	
Cross Ref.	14096353X0002		
Application	Foton		
	MAN	81523156156	

		RL3526NA38	
		Ports 1, 21: M16x1.5-6H Installation hole: 2xM8-6H Trailer position 73 °	
Cross Ref.	9617234210		
Application	Mercedes	0034305981	
	NATO		
		RL3526NE	
		Ports: 2xM16x1.5 Parker Comment: With Warning Light Switch	
Cross Ref.	DPM94 AAX		
Application	DAF	1505334	
	Iveco	8137037	
Repair Kits	RL3526NE-9		
		RL3526NE-A	
		Ports: 3xM16x1.5	
Cross Ref.	DPM95 AAX		
Alternative	9617231170		
Application	DAF	1524294	
	Iveco	41002766	
		RL3526XD01	
		All ports hole: 6xΦ10 Installation hole: Φ7	
Cross Ref.	DPM64MP		
Application	Mercedes		
		RL3526NE-B	
		Ports 1, 21, 22 thread: M16x1.5 Installation hole: M8x1	
Cross Ref.	DPM28A		
Application	Iveco	SPR1	
	RVI	5010422400	

Parking Brake Valve		4.03
RL3526VA		
	Ports 1, 2: M14X1.5	
Cross Ref.	9617210000	
Application	DAF	1524300
	MAN	81523156068
		81523156054
	Mercedes	0004307881
Repair Kits	RL3526VA-9	
RL3526VB		
	Ports 1, 2=M12x1.5 Exhaust Hole: $\Phi 8$ Installation Hole: M6 Installation Hole Spacing: (39 ± 0.2) mm	
Cross Ref.	9617210040	
Application	DAF	1506443
	Ford	86015528
	Iveco	41822694
	MAN	81523156165
	RVI	5000544905
	Scania	405673
	Volvo	4822431
RL3526WA01		
	Ports 1, 2=M12x1.5 Exhaust Hole: $\Phi 8$ Installation hole: M6 Installation hole spacing: (39 ± 0.2) mm	
Cross Ref.	9617100560	
Application	American Truck	
RL3526WA02		
	Ports 1, 2: M14x1.5-6H Installation hole: 2xM6-6H	
Cross Ref.	9617100540	
Application	Foton	





RL3526PA	
	Ports: All M14x1.5
Cross Ref.	9617011000
Alternative	HB1132, 328009111
Application	Scania 400555
	MAN 11026510099
	Iveco 1373808
Repair Kits	RL3526PA-9
RL3526PD	
	All Ports: M14x1.5
Cross Ref.	9617011050
Alternative	HB1132, 328011011
Application	Scania 400555
	MAN 11026530099
	Iveco 2498634
Repair Kits	RL3526PD-9
RL3526PB	
	All Ports: M14x1.5 Comment: Right Hand
Cross Ref.	9617020010
Alternative	HB1122 328012011
Application	DAF 0176628
	Iveco 42017083
	Volvo 1509055
Repair Kits	RL3526PB-9
RL3526PC	
	All Ports: M14x1.5 Comment: Right Hand
Cross Ref.	9617020080
Application	Scania 255571
Repair Kits	RL3526PC-9

Parking Brake Valve		4.03	
		RL3526XB01	
		Ports: 3xM16x1.5-6H Installation hole: 4xΦ9/2xΦ6.5 Parking position 73°	
Cross Ref.	9617231220		
Application	DAF		
	Scania	1324425	
		RL3526XB03	
		Ports 1, 21, 22: M16x1.5-6H Installation hole: Φ9, Φ6.5 Parking position 73°	
Cross Ref.	9617232170		
Application	DAF	1506757	
	Scania	1408332	
		RL3526XC01	
		All Ports: M16x1.5 Installation hole: 2xM8 Parking position 73°	
Cross Ref.	9617231250		
Application	DAF	1519266	
	Mercedes	0034307381	
		RL3526XA01	
		Ports 1,2,3: M12x1.5	
Application	Foton		

		RL3526XA02	
		Ports A, V: M16x1.5-6H Port E thread: 8.5mm	
Cross Ref.	8845019220		
Application	Foton		
		RL3526WL01	
		Ports 11,21,22: M14x1.5 Mounting: M6	
Cross Ref.	HB1219		
Alternative	9617222690		
Application	RVI	5000716328	
		RL3526QL01	
		Ports 1,2: M14x1.5 Mounting: M6	
Cross Ref.	HB1242		
		RL3526QL02	
		Ports 1,2: M14x1.5 Mounting: M6	
Cross Ref.	HB1142		
Alternative	9617210020		
Application	Volvo FL6	6876922	

Parking Brake Valve 4.03	
RL3526YL01	
	Inlet: Connection For Plastic Tube Φ 10mm Delivery: Connection For Plastic Tube Φ 15mm
Cross Ref.	M304950
Application	Truck
RL3526YL02	
	Inlet: M18x1.5 Delivery: M22x1.5 Aux Delivery: M12X1.5
Cross Ref.	M303751
Application	Truck
RL3526XE01	
	Ports: 3xNPT 1/4
Cross Ref.	K001726
Application	Volkswagen

Trailer Brake Hand Control Valve 4.03	
RL3526LA	
	Ports: 1/4" NPT
Repair Kits	RL3526LA-9

RL3526FA	
	Ports: 1/4"NPT
Cross Ref.	APSA5890
Alternative	961710133 0
Application	Mercedes
Repair Kits	RL3526FA-9
RL3526LB	
	Ports: 1/4" NPT
Application	Japanese
Repair Kits	RL3526LB-9
RL3526KA	
	Ports: 1/4" NPT
Cross Ref.	5900G
Application	Truck
RL3526TA	
	Ports: 1/4"NPT
Cross Ref.	276270
Application	American Truck
Repair Kits	RL3526TA-9

P.T.O Shift Valve Assy. 4.04	
	RL3526ZA01
	Supply: 1/8NPT Delivery: 1/8NPT
Cross Ref.	WA118373
Application	American Truck



Control Valve 4.05	
	RL3526HB02
	Port 1: NPT1/4 Port 21: NPT1/4
Cross Ref.	920100

TW-2 Flick Lever Control Valve 4.05	
	RL3526GA
	Ports: 2xsup+2xdel=1/8"NPT Comment: Basic TH3 Valve-2 Position
Cross Ref.	280904
	RL3526GB
	Ports: 2xsup+2xdel=1/8"NPT Comment: Basic TH2 Valve-3 Position
Cross Ref.	280905







TW-1 Control Valve 4.05	
	RL3526HC01
	Supply: 1/8"PT Delivery: 1/8"PT Installation: 2xW3/16-24
Cross Ref.	229635
Application	American Truck
	RL3526HC02
	Supply: 1/8"NPT Delivery: 1/8"NPT Installation: 2xW3/16-24
Cross Ref.	229635
Application	American Truck





Flick Lever Control Valve 4.05	
	RL3526HA
	Ports: Sup+Del=M10x1 Comment: TW1 Valve With Brass Lever
Application	Universal
	RL3526HB
	Ports: Sup+Del=1/8"NPT Comment: TW1 Valve With Brass Lever
Application	Universal

TW-4 Control Valve 4.05	
	RL3526HC04
	Supply: 1/8" PT Delivery: 1/8" PT Installation: 2xW3/16-24
Cross Ref.	276635
Application	American Truck
	RL3526HC05
	Supply: 1/8"NPT Delivery: 1/8" NPT Installation: 2xW3/16-24
Cross Ref.	276635
Application	American Truck

TW-3 Control Valve		4.05
RL3526HC03		
	Ports=All NPT1/8 Installation Hole: 3/16-24BSW Installation Hole Spacing: (38 ± 0.1)mm	
Application	American Truck	
RL3526HC06		
	Supply: 1/4"PT Delivery: 1/4"PT Installation: 2xW3/16-24	
Cross Ref.	225892	
Application	American Truck	
RL3526HC07		
	Supply: 1/4"NPT Delivery: 1/4"NPT Installation: 2xW3/16-24	
Cross Ref.	225892	
Application	American Truck	
RL3526HC13		
	Ports 1,2=M16x1.5 Installation Hole: Φ7 Installation Hole Spacing: 32mm	
Cross Ref.	43-108	

TW-11 Control Valve		4.05
RL3526HC08		
	Supply: 1/8"PT Delivery: 1/8"PT Exhaust: 1/8"PT Installation: 2xUNC1/4-20	
Cross Ref.	065316	
Application	Van Horn Truck	
RL3526HC09		
	Supply: 1/8"NPT Delivery: 1/8"NPT Exhaust: 1/8"NPT Installation: 2xUNC1/4-20	
Cross Ref.	065316	
Application	Van Horn Truck	
RL3526HC10		
	Supply: 1/8"PT Delivery: 1/8"PT Exhaust: 1/8"PT Installation: 2xUNC1/4-20	
Cross Ref.	065356	
Application	American Truck	
RL3526HC11		
	Supply: 1/8"NPT Delivery: 1/8"NPT Exhaust: 1/8"NPT Installation: 2xUNC1/4-20	
Cross Ref.	065356	
Application	American Truck	



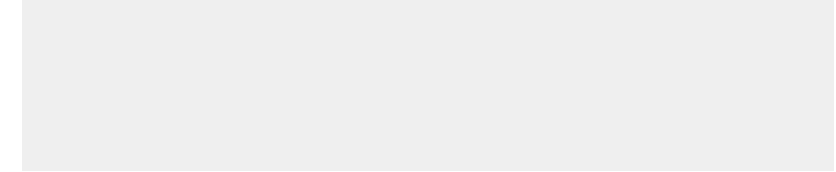

Repair Kits	Kits P/N	Repair Kits For	Cross Ref.	Application
	RL3526AK-9 RL3526BK-9	RL3526AK RL3526BK	9617220022	Scania 639131
	RL3526BA-9 RL3526BB-9	RL3526BA RL3526BB	9617230012	Scania 1350477
	RL3526CK-9 RL3526EK-9 RL3526FK-9 RL3526RA-9 RL3526RB-9	RL3526CK RL3526EK RL3526FK RL3526RA RL3526RB	9617220032	DAF 0691984 Iveco 42485350 Mercedes 0034303281
	RL3526DX-9 RL3526DY-9	RL3526DX RL3526DY	9617230002	DAF 0513798 Iveco 93161152 MAN 81523156129 Mercedes 0034305281
	RL3526NA-9 RL3526NB-9	RL3526NA RL3526NB	9617230042	DAF 1279601 Iveco 93161490
	RL3526NE-9	RL3526NE		
	RL3526VA-9	RL3526VA	9617210082	Mercedes 0034305381

Repair Kits	Kits P/N	Repair Kits For	Cross Ref.	Application
	RL3526PA-9 RL3526PD-9	RL3526PA RL3526PD	9617010002	Scania 638768
	RL3526PB-9 RL3526PC-9	RL3526PB RL3526PC	9617020012	Scania 319859
	RL3526TA-9	RL3526TA		American Truck
	RL3526LA-9 RL3526LB-9	RL3526LA RL3526LB		
	RL3526FA-9	RL3526FA		











LSV Relay. Mech Controlled 4.06	
	<p>RL3523AA01</p> <p>Inshot: 0.8 α : 30° Ratio: 1:8 Ports 1, 2: M22x1.5 Port 4: M16x1.5</p>
	<p>RL3523AA02</p> <p>α :30° Ports: All=M16x1.5</p>
	<p>RL3523AA03</p> <p>α :30° Ports: 1=M22x1.5 Voss 2=M22x1.5 Voss, 4=M16x1.5 Voss</p>



LSV Relay. Mech Controlled 4.06	
	<p>RL3523AA04</p> <p>Inshot: 0.8 α : 30° Ratio: 1:8 Ports 1,2: M16x1.5 Port 4: M16x1.5</p>
	<p>RL3523AA05</p> <p>α : 30° Ports: 1=M22x1.5, 2=M16x1.5, 4=M16x1.5</p>
	<p>RL3523AA06</p> <p>α : 30° Ports: 1=M22x1.5, 2=M16x1.5, 4=M16x1.5</p>





	<p>RL3523AA07</p> <p>Inlet Port 1: M22x1.5 Outlet Port 2: M22x1.5 Control Port 4: M16x1.5</p> <p>Cross Ref. 1104935600188 Application Foton Ollin</p>
	<p>RL3523AA08</p> <p>α : 30° Ports: All=NPT3/8</p>
	<p>RL3523AA09</p> <p>α : 30° Ports: 1=M22x1.5, 2=M16x1.5, 4=M16x1.5</p> <p>Cross Ref. 475 710 022 0 Application DAF 0643260</p>
	<p>RL3523AA10</p> <p>α : 60° Ports: All=M16x1.5</p>
	<p>RL3523AA-A</p> <p>Inshot: 0.5 α : 30° Ratio: 1:8 Ports: 1=M22x1.5, 2=M16x1.5, 4=M16x1.5</p> <p>Repair Kit RL3523AA-A-9</p>



LSV Relay. Mech Controlled		4.06
	RL3523AA-C	
	$\alpha : 30^\circ$ Ports: 1=M16x1.5, 2=M22x1.5, 4=M16x1.5	
	RL3523AB	
	Inshot: 0.5 $\alpha : 30^\circ$ Ratio: 1:8 Ports 1,4: M18x1.5 Port 2: M20x1.5	
	RL3523AB02	
	Port 1: M22x1.5 PortS 2, 4: M16x1.5	
Cross Ref.	4757101210	
Application	DAF	1518952
	Volvo	1625753
	RL3523AB10	
	Ports 1, 3: M22x1.5 Ports 2, 4: M16x1.5	
Cross Ref.	4757100060	
Application	DAF	1518120
	Volvo	1607836
	RL3523AB12	
	$\alpha : 30^\circ$ Ports 1, 2: M22x1.5 Port 4: M16x1.5 Installation bolt thread: M8	
	RL3523AB13	
	Ports 1, 2: M22x1.5 Port 4: M16x1.5 Installation bolt thread: M8	

	RL3523AB-F	
	$\alpha : 30^\circ$ Ports: 1=M22x1.5, 2=M16x1.5, 4=M16x1.5	
Cross Ref.	4757100290	
Application	DAF	675644
	RL3523AB-G	
	$\alpha : 30^\circ$ Ports: 1=M22x1.5, 2=M16x1.5, 4=M16x1.5	
	RL3523AB-A	
	Inshot: 0.6, $\alpha : 60^\circ$, Ratio: 1:8 Ports: 1=M22 Voss, 2=M22 Voss 4=M16 Voss	
Cross Ref.	4757100080	
Alternative	BR4420	
Application	Mercedes	A0014313312008
Repair Kit	RL3523AB-A-9	
	RL3523AB-B	
	Inshot: 0.5, $\alpha : 60^\circ$, Ratio: 1:8 Ports: 1=M16X1.5, 2=M16X1.5 4=M16X1.5	
Application	MAN	2017790
	Iveco	500005480
	Mercedes	0014313212
	RL3523AB-C	
	Inshot: 0.5, $\alpha : 30^\circ$, Ratio: 1:8 Ports: 1=M22X1.5 Voss, 2=M22X1.5 Voss 4=M16X1.5 Voss	
Cross Ref.	4757100360	
Application	Mercedes	0014318112
		0014318212
Repair Kit	RL3523AB-C-9	

LSV Relay. Mech Controlled 4.06	
RL3523AB-D	
	Inshot: 0.5, α : 30°, Ratio: 1:8 Ports: 1=M16x1.5, 2=M16x1.5, 4=M16x1.5
Cross Ref.	4757100200
Alternative	BR4411
Application	DAF 1518121 Mercedes 0014313312
Repair Kit	RL3523AB-D-9
RL3523AB-E	
	Inshot: 0.5, α : 60°, Ratio: 1:8 Ports: 1=M16x1.5, 2=M16x1.5, 4=M16x1.5
Application	DAF 1518120 Volvo 1607836
Repair Kit	RL3523AB-E-9
RL3523AB-H	
	α : 60° Ports: 1=M22x1.5, 2=M16x1.5, 4=M16x1.5
RL3523AB-K	
	α : 30° Ports: 1=M22x1.5, 2=M16x1.5, 4=M16x1.5
RL3523AB-L	
	Port 1: M22x1.5 Voss Port 2: M22x1.5 Voss, M16x1.5 Voss Port 4: M16x1.5 Voss
Cross Ref.	475 710 136 0
Application	DAF PACCAR Scania Mercedes Evobus

RL3523CA	
	α : 30°, Ratio: 1:8, Inshot: 0.5 Ports: 1=M16, 1-2=M22 2(Side)=M22, 2(Under)=M16, 4=M16 Comments: Inlet Port Filters
Cross Ref.	4757120040
Application	DAF 1518127
Repair Kit	RL3523CA-9
RL3523CB	
	α : 20°, Ratio: 1:8, Inshot: 0.5 Ports: 1=M16, 1-2=M22, 2(side)=M22 2(under) =M16, 4=M16 Comments: With Lever And P Rubber
Cross Ref.	4757120000
Alternative	351012001
Application	DAF 1325324 RVI AI39780001
Repair Kit	RL3523CB-9
RL3523CC	
α : 20°, Ratio: 1:8, Inshot: 0.5 Ports: 1=M16, 1-2=M22, 2(side)=M22 2(under)=M16, 4=M16 Comments: Without Lever	
Cross Ref.	4757120050
Application	Trailers
Repair Kit	RL3523CC-9
RL3523GB	
	All ports thread: M12x1.5 Installation hole: ϕ 9
Cross Ref.	4758003010
Application	DAF 0736922 Dennis 613722 Iveco 08122059 MAN 88521806001 Mercedes 6623201858 RVI 5010056468 Scania 1339908

LSV Relay. Pneu Controlled 4.07	
RL3523AK	
	Ratio: 1:8 , Inshot: 0.5 , Cont.p4: 6.5 Empty P41/42: 3.4 , Empty P2: 4.5 Laden P41/42: 4.4 , Empty P2: 6.0 Ports: 1=M22x1.5. 2, 4=M16x1.5 41, 42=M12x1.5
Cross Ref.	4757111080
Application	Volvo 1628955
Repair Kit	RL3523AK-9
RL3523AK01	
	Port 1=M22x1.5 Ports 2,4=M16x1.5 Ports 41,42=M12x1.5
Cross Ref.	4757110750
Application	Volvo 1628955
RL3523AK03	
	Ports 1,2,4=M16x1.5 Ports 41,42=M12x1.5
RL3523AK04	
	Ports 1,2=M22x1.5 Voss Port 4=M16x1.5 Voss Ports 41,42=M16x1.5 Voss
Cross Ref.	4757111550
Application	DAF 1517493 RVI 5010422513

RL3523AK06	
	Ports 1,2,4 thread: M16x1.5 Ports 41,42 thread: M12x1.5 Installation bolt thread: M8
Cross Ref.	4757110290
Application	DAF 0378234
RL3523AK-D	
	Regulating Ratio: 1:8 P41/42 Empty: 0.5bar P2 Empty: 1.4bar (P4= 6bar) P41/42 Laden: 5,9bar P2 Laden: 6 bar (P4= 6bar) P41/42: 0bar P2: 1,2 bar (P4= 6bar) Ports 1,2: M22x1.5Voss Ports 41,42: M16x1.5Voss Port 43: M16x1.5 Break Point: 0.5x0.1bar
Cross Ref.	4757111260
Application	DAF 1302096 MAN N2521160021
RL3523AK-A	
	Ratio: 1:8 , Inshot: 0.5 , Cont.P4: 7.0 Empty P41,42: 0.35, Empty P2: 1.8 Laden P41,42: 7.2 , Empty P2: 7.0 Ports: 1, 2, 4=M16X1.5. 41, 42=M12X1.5
Cross Ref.	4757110120
Application	MAN 81521616268
Repair Kit	RL3523AK-A-9
RL3523AK-B	
	Ratio: 1:8 , Inshot: 0.6 , Cont.p4: 6.5 Empty P41/42: 0.6 , Empty P2: 1.4 Laden P41/42: 4.3 Empty P2: 6.5 Ports: 1, 2=M22x1.5 Voss 4, 41, 42=M16x1.5 Voss
Cross Ref.	4757110240
Application	DAF 1518960 Mercedes 0014319412

LSV Relay. Pneu Controlled 4.07	
	RL3523AK-E
	Ports 1,2=M16x1.5 Port 4=M16x1.5 Ports 41,42=M12x1.5
Cross Ref.	4757111010
Application	Mercedes

LSV Relay. Emergency Valve 4.08	
	RL3523AK-C
	Ratio: 1:8 , Inshot: 0.5 Ports: 1/4 M22x1.5, 2 M16x1.5, 41, 42 M12x1.5
Cross Ref.	4757145000
Alternative	BR5522, 602005001
Application	Mercedes 6984313712 Krone 945013 Kogel 351000, 6502186, 76934
Repair Kit	RL3523AK-C-9

	RL3523AK-H
	Ports 1,4=M22x1.5 Port 2=M16x1.5 Ports 41,42=M12x1.5









	RL3523BB
	Ratio: 1:8 , Inshot: 0.7 Ports: 1/4, 2, 1-2=M22x1.5, 1=M16x1.5 41, 42 M12x1.5
Cross Ref.	4757155000
Alternative	BR5504
Application	DAF 1506232 Schmitz 8283011000
Repair Kit	RL3523BB-9



	RL3523BB-A
	Ratio: 1:8 , Inshot: 0.5 Ports: 1/4,M16x1.5 . 2, 1-2=M22x1.5 1=M16x1.5, 41, 42 M12x1.5
Cross Ref.	4757150000
Alternative	MS10A
Application	LOHR A05030109



	RL3523DA
	Inshot: 0.4 Ports: 1, 2 M22x1.5, 41, 42 M12x1.5
Cross Ref.	4757004030
Alternative	BR5522, 602005001
Application	RVI 5600528058 MAN 1065242 Iveco 8122061 Krone 945015
Repair Kit	RL3523DA-9

	RL3523GC
	Ports 1, 2 thread: M22x1.5 Ports 14, 41, 42 thread: M16x1.5
Cross Ref.	4757210010
Application	Volvo 3181315 KAMAZ 5297, 5460

Spring Box 4.09	
	RL3523FJ
	Comment: Rod Length 185mm
Application	DAF, Foden

Repair Kits	Kits P/N	Repair Kit For	Cross Ref.	Application
	RL3523AA-A-9 RL3523AB-A-9 RL3523AB-B-9 RL3523AB-C-9 RL3523AB-D-9 RL3523AB-E-9	RL3523AA-A RL3523AB-A RL3523AB-B RL3523AB-C RL3523AB-D RL3523AB-E	4757100012	Scania 1697318 Volvo 1697318
	RL3523AK-9	RL3523AK	4757110002	Volvo 270617
	RL3523CA-9 RL3523CB-9 RL3523CC-9	RL3523CA RL3523CB RL3523CC	4757120002	DAF 1518974 RVI 5021170231
	RL3523AK-A-9	RL3523AK-A	4757110002	Volvo 270617
	RL3523AK-C-9	RL3523AK-C	4757140002	DAF FBU5577 Iveco 93161487
	RL3523BB-9	RL3523BB	4757150002	RVI 5021170236
	RL3523DA-9	RL3523DA	4757000042	Volvo 272799 Iveco 222469
	RL3523AA-8	RL3523AA		
	RL3523AA11	RL3523AK		

Quick Release Valve 4.10	
	<p align="center">RL3516NA01</p> <p>Port 1: M22x1.5 Port 2: M16x1.5 Material: Aluminium Alloy</p>
	<p align="center">RL3516EC</p> <p>Port 1: NPT3/8 Port 2: NPT1/4 Material: Zinc Alloy</p>
	<p align="center">RL3516EJ</p> <p>Port 1: M22x1.5 Port 2: NPT3/8 Port 3: NPT3/8 Material: Zinc Alloy</p>
	<p align="center">RL3516EL</p> <p>Port 1: NPT1/4 Port 2: NPT1/4 Port 3: NPT1/4 Material: Zinc Alloy</p>
	<p align="center">RL3516EK</p> <p>Port 1: NPT1/2 Port 2: NPT1/4 Port 3: NPT3/8 Material: Zinc Alloy</p>
	<p align="center">RL3516EU</p> <p>Port 1: NPT1/4 Port 2: NPT3/8 Port 3: NPT1/4 Material: Zinc Alloy</p>

	<p align="center">RL3516QA01</p> <p>Ports: All M22x1.5</p> <p>Cross Ref. 9750010000 Alternative DB2110, 356009011 Application Iveco 2472250</p>
	<p align="center">RL3516ED</p> <p>Port Sup 1(11): M22x1.5 Port Del(2): M22x1.5 Port Exh(3): M22x1.5 Material: Zinc Alloy</p> <p>Cross Ref. 9735000000 Application Scania 1339907 Iveco 1299031</p>
	<p align="center">RL3516EE</p> <p>Port Sup 1(11): 3/8" NPT Port Del(2): 3/8" NPT Port Exh(3): 3/8" NPT Material: Zinc Alloy</p> <p>Cross Ref. 9735000030 Application DAF 1505409 Iveco 61665462 Mercedes 0006201207 RVI 0024551020</p>
	<p align="center">RL3516BH01</p> <p>Port Sup 1(11): 1/2" PT Port Del(2): 3/8" NPT Port Exh(3): 3/8" NPT Material: Zinc Alloy</p> <p>Cross Ref. 9735000140 Application Scania 186568</p>

Quick Release Valve		4.10
RL3516EG		
	Port Sup 1(11): 3/8"PT Port Del(2): 1/4"NPT Port Exh(3): 3/8" NPT Material: Zinc Alloy	
Cross Ref.	9735000110	
Application	DAF	1518272
	RVI	0037434900
RL3516EH		
	Port Sup 1(11): M16x1.5 Port Del(2): M16x1.5 Port Exh(3): M16x1.5 Comment: RVI-5000122053 Material: Zinc Alloy	
Cross Ref.	9735000060	
Application	DAF	1505153
	Iveco	5000792440
	MAN	ZG046580002
	RVI	5000122053
RL3516ET		
	Port 1: M22x1.5 Port 2: M16x1.5 Port 3: M22x1.5 Material: Zinc Alloy	
Cross Ref.	9735000180	
RL3516EX		
	Port 1: M22x1.5 Port 2: M16x1.5 Port 3: M16x1.5 Material: Zinc Alloy	
Cross Ref.	9735000130	
Application	Scania	1676783

RL3516UA01	
	Port 1: M22x1.5 Port 2: 4xM16x1.5 Exhaust 3: M22x1.5
Cross Ref.	9735000380
Application	DAF 1504911
	MAN N2509990170
	RVI 5021170468
	Scania 1738495
RL3516XA01	
	Supply 11,12: M22x1.5 Delivery 2: M16x1.5 Exhaust 3: M22x1.5
Cross Ref.	9735000510
Application	Scania 1788954
RL3516YA01	
	Ports: All M16x1.5
Cross Ref.	350360011
Application	American Trailer
RL3516YA02	
	Port 1: M22x1.5 Port 2: M16x1.5 Material: Aluminium Alloy
RL3516AA	
	Inlet Port 1: M18x1.5-6H Outlet Port 2: NPT 1/4
Application	Foton Ollin F5815356X0055

Quick Release Valve		4.10
RL3516AA60		
	Port 1: NPT3/8 Port 2: NPT1/4 Material: Aluminium Alloy	
Application	XiaMen King Long	
RL3516AB		
	Inlet Port 1: NPT3/8 Outlet Port 2: NPT1/4	
Cross Ref.	355035	
Application	Lifan Junma	
RL3516QC01		
	Ports: All M22x1.5	
RL3516BC		
	Port 1: NPT3/8 Port 2: NPT1/4 Material: Aluminium Alloy	
RL3516BD		
	Ports 1,2,3: M22x1.5 Material: Aluminium Alloy	
RL3516BC25		
	Port 1: PT3/8 Port 2: NPT3/8 Installation hole: $\Phi 9.5$ Installation hole spacing: (38 ± 0.5) mm	
Cross Ref.	9735000170	
Application	VW 11130/14, 170/16220	

	RL3516BE	
	Port 1: NPT3/8 Port 2: NPT3/8 Port 3: NPT3/8 Material: Aluminium Alloy	
RL3516BF		
	Port 1: NPT1/2 Port 2: NPT3/8 Port 3: NPT3/8 Material: Aluminium Alloy	
RL3516BG		
	Port 1: NPT3/8 Port 2: NPT1/4 Port 3: NPT3/8 Material: Aluminium Alloy	
RL3516BH		
	Port 1: M16x1.5 Port 2: M16x1.5 Port 3: M16x1.5 Material: Aluminium Alloy	
RL3516BT		
	Port 1: M22x1.5 Port 2: M16x1.5 Port 3: M22x1.5 Material: Aluminium Alloy	
Cross Ref.	KX2552/3	
Application	Scania	1422152
RL3516BK		
	Port 1: NPT1/2 Port 2: NPT1/4 Port 3: NPT3/8 Material: Aluminium Alloy	
RL3516BM		
	Port 1: NPT3/8 Port 2: NPT3/8 Port 3: - Material: Aluminium Alloy	

Quick Release Valve		4.10
RL3516BR		
	Port 1: NPT1/4 Port 2: NPT1/4 Port 3: NPT3/8 Material: Aluminium Alloy	
	RL3516BX	
Port 1: M22x1.5 Ports 2,3: M16x1.5 Material: Aluminium Alloy		
Cross Ref.	9735000470	
Application	Volvo	3173152

QR-1 Quick Release Valve		4.10
RL3516LB		
	Ports Sup: 3/8" PT Ports Del: 1/4"PT	
	Cross Ref.	229813
Application	American Trailer	
RL3516LA14		
Ports Sup: 3/8" NPT Ports Del: 1/4"NPT		
Cross Ref.	229813	
Application	American Trailer	
RL3516LA-A		
Ports Sup: 1/2" PT Ports Del: 1/4"PT		
Cross Ref.	229844	
Application	American Trailer	

RL3516LA17		
Ports Sup: 1/2" NPT Ports Del: 1/4"NPT		
Cross Ref.	229844	
Application	American Trailer	
RL3516LA		
Ports Sup : 3/8"PT Ports Del: 3/8" PT		
Cross Ref.	229859	
Application	CAMC	3516AD-010
RL3516LA16		
Ports Sup: 3/8"NPT Ports Del: 3/8" NPT		
Cross Ref.	229859	
Application	American Trailer	
RL3516LC		
Ports Sup : 1/2"PT Ports Del: 3/8"PT		
Cross Ref.	229860	
Application	American Trailer	
RL3516LA15		
Ports Sup: 1/2"NPT Ports Del: 3/8" NPT		
Cross Ref.	229860	
Application	American Trailer	

QR-1 Quick Release Valve		4.10
		RL3516LD
	Ports Sup : 1/4" PT Ports Del: 1/4" PT	
Cross Ref.	281024	
Application	American Trailer	
		RL3516LA18
		Ports Sup: 1/4" NPT Ports Del: 1/4" NPT
Cross Ref.	281024	
Application	American Trailer	
		RL3516LE
	Ports Sup : 3/8" PT Ports Del: 3/8" PT Ports Exh: 3/8" PT	
Cross Ref.	288251	
Application	American Trailer	
Repair Kit	3516 018 006 9	
		RL3516LA19
		Ports Sup: 3/8" NPT Ports Del: 3/8" NPT Ports Exh: 3/8" NPT
Cross Ref.	288251	
Application	American Trailer	

	RL3516LA12	
	Sup: M16x1.5 Del: M16x1.5	
		RL3516LA20
	Sup: M22x1.5 Del: M16x1.5	
		RL3516BD34
	Ports: M22x1.5-6H Installation hole: $\Phi 9.5$ Installation hole spacing: $(38 \pm 0.15)\text{mm}$	
Cross Ref.	4735010040	
Application	Kogel	314032
		RL3516DA
	Ports Sup 1(11): NPT1/4 Ports Del(2): NPT1/4	
Cross Ref.	03342-56000	
Application	Mercedes, DAF Scania, Volvo MAN, HINO, ISUZU	

QR-1C Quick Release Valve		4.10
		RL3516FD
	Ports Sup: 1/4"PT Ports Del: 3/8"PT Balance: 1/4"PT	
Cross Ref.	289714	
Application	American Trailer	

QR-1C Quick Release Valve 4.10	
RL3516FD07	
	Ports Sup: 1/4"NPT Ports Del: 3/8"NPT Balance: 1/4"NPT
Cross Ref.	289714
Application	American Trailer
RL3516FE	
	Ports Sup: 1/4"PT Ports Del: 1/4"PT Balance: 1/4"PT
Cross Ref.	289182
Application	American Trailer
RL3516FD08	
	Ports Sup: 1/4"NPT Ports Del: 1/4"NPT Balance: 1/4"NPT
Cross Ref.	289182
Application	American Trailer
RL3516FF	
	Ports Sup: 1/4"PT Ports Del: 3/8"PT Ports Exh: 1/2"PT Balance: 1/4"PT
Cross Ref.	107881
Application	American Trailer

RL3516FD09	
	Ports Sup: 1/4"NPT Ports Del: 3/8"NPT Ports Exh: 1/2"NPT Balance: 1/4"NPT
Cross Ref.	107881
Application	American Trailer



LQ-2 Limiting And Quick Release Valve 4.10	
RL3516VA01	
	Supply: 3/8"PT Delivery: 3/8"PT Control: 1/4"PT
Cross Ref.	229505
Application	American Trailer
RL3516VA07	
	Supply: 3/8"NPT Delivery: 3/8"NPT Control: 1/4"NPT
Cross Ref.	229505
Application	American Trailer
RL3516VA02	
	Supply: 1/2"PT Delivery: 1/4"PT Control: 1/4"PT
Cross Ref.	229507
Application	American Trailer

LQ-2 Limiting And Quick Release Valve 4.10	
RL3516VA05	
	Supply: 1/2"NPT Delivery: 1/4"NPT Control: 1/4"NPT
Cross Ref.	229507
Application	American Trailer
RL3516VA03	
	Supply: 3/8"PT Delivery: 1/4"PT Control: 1/4"PT
Cross Ref.	229509
Application	American Trailer
RL3516VA06	
	Supply: 3/8"NPT Delivery: 1/4"NPT Control: 1/4"NPT
Cross Ref.	229509
Application	American Trailer
RL3516VA04	
	Supply: 3/8"PT Delivery: 3/8"PT Control: 1/4"PT Exhaust: 3/8"PT
Cross Ref.	288417
Application	American Trailer



RL3516VA08	
	Supply: 3/8"NPT Delivery: 3/8"NPT Control: 1/4"NPT Exhaust: 3/8"NPT
Cross Ref.	288417
Application	American Trailer

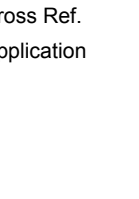

Quick Release Valve 4.10	
RL3516TA	
	Port Sup 1(11): M16x1.5 Port Del(2): M16x1.5 Port Exh(3): M16x1.5
Cross Ref.	356013011
Application	DAF 1518273 Mercedes 0044292544 Truck
RL3516TB	
	Port Sup 1(11): M22x1.5 Port Del(2): M22x1.5 Port Exh(3): M22x1.5
RL3516TC	
	Port Sup 1(11): 1/2" NPT Port Del(2): 1/4" NPT Port Exh(3): 3/8"NPT
RL3516TD	
	Port Sup 1(11): M22x1.5 Port Del(2): M16x1.5 Port Exh(3): M22x1.5

LQ-5 Bobtail Limiting Valve		4.10
		RL3516WA01
		Supply: 3/8"PT Delivery: 3/8"PT Control: 1/8"PT
Cross Ref.	065154	
Application	American Trailer	
		RL3516WA02
		Supply: 3/8"NPT Delivery: 3/8"NPT Control: 1/8"NPT
Cross Ref.	065154	
Application	American Trailer	

		RL3516WB
		Ports Sup: 3/8" PT Ports Del: 3/8"PT Nominal Hold Off Pressure: 4psi Nominal Equalizing Pressure: 60psi
Cross Ref.	289144	
Application	American Truck	
		RL3516WA04
		Ports Sup: 3/8" NPT Ports Del: 3/8" NPT Nominal Hold Off Pressure: 4psi Nominal Equalizing Pressure: 60psi
Cross Ref.	289144	
Application	Heavy Duty Trucks	



LQ-4 Quick Release Valve		4.10
		RL3516WA
		Ports Sup: 3/8"PT Ports Del: 3/8" PT Nominal Hold Off Pressure: 20psi Nominal Equalizing Pressure:70psi
Cross Ref.	101311	
Application	Heavy Duty Trucks	
		RL3516WA03
		Ports Sup: 3/8" NPT Ports Del: 3/8" NPT Nominal Hold Off Pressure: 20psi Nominal Equalizing Pressure: 70psi
Cross Ref.	101311	
Application	Heavy Duty Trucks	





Quick Release Valve		4.10
		RL3516JA
		Ports Sup : 1/2"NPT Ports Del: 3/8" NPT
Cross Ref.	KN32010	
Application	Heavy Duty Trucks Semi-Trailers	
		RL3516SA
		Ports Sup 1(11): 1/2" NPT Ports Del(2): 3/8" NPT

Quick Release Valve		4.10
 <p>Supply: 1/2"PT, RC1/2 Delivery: 1/4"PT, RC1/4</p> <p>Application American Trailer</p>		RL3516ZA01
		<p>Supply: 1/2"NPT Delivery: 1/4"NPT</p> <p>Application American Trailer</p>
 <p>All Ports thread NPT3/8 Installation hole: $\phi 8.8$</p> <p>Cross Ref. 802743 Application American Truck</p>		RL3516QD01

 <p>Cross Ref. 6125G02-3516010 Application XiaMen King Long</p>	RL3516CA15	Ports: All M22x1.5
 <p>Cross Ref. 800333 Application American Trailer</p>	RL3516MA	Port Sup 1(11): 1/2"NPT Port Del(2): 1/2"NPT
 <p>Application American Trailer</p>	RL3516MB	Port Sup 1(11): 1/2"NPT Port Del(2): 1/2"NPT

Repair Kit	Kits P/N	Repair Kit For	Cross Ref.	Application
	RL3516LE-9	RL3516LE		

Trailer Control Valve		4.11
RL3522AH		
	Predominance: 0bar-fixed Ports: All M16x1.5	
Cross Ref.	9730024020	
Alternative	AB2761, 355021001	
Application	Scania	293139
	Iveco	2516806
Repair Kit	RL3522AH-9	
RL3522AZ		
	Predominance: 0bar-adjustable Ports: All M22x1.5	
Cross Ref.	9730020070	
Application	Iveco	222793
RL3522AZ-A		
	Port: All M16x1.5 Predominance Adjustable: Yes	
Cross Ref.	9730024230	
Application	Scania	305416
	RL3522AB01	
	Ports: All M16x1.5	
Cross Ref.	9730024000	
Application	Mercedes	0014314905

	RL3522AZ13	
	Ports 1,2,41,42,43: M22x1.5	
Cross Ref.	9730020000	
Alternative	AC590A, 355019011	
Application	DAF	1519318
	Iveco	00000668
	MAN	82523016000
	RL3522BB	
	All Ports: 7xM16x1.5 Installation bolt: 4xM8	
Cross Ref.	9730025000, 9730025060	
Application	DAF	
	Iveco	42000821
	Mercedes	0014316605
	RL3522BH	
	Predominance: 0bar-fixed Ports: All M16X1.5	
Cross Ref.	9730025200	
Alternative	AB2795, 355021001	
Application	Mercedes	0014316705
Repair Kit	RL3522BH-9	
	RL3522BJ	
	Predominance: 0.2bar-Adjustable Ports: All M16x1.5 Comment: With Port 21	
Cross Ref.	9730025010	
Alternative	AB2782, 335027001	
Application	MAN	81523016117
	Mercedes	0014318605
Repair Kit	RL3522BJ-9	

Trailer Control Valve		4.11
RL3522BJ-A		
	Predominance: 0.2bar-Adjustable Ports: All M16X1.5	
Cross Ref.	9730025210	
Application	Volvo	1607887
	Iveco	04773986
Repair Kit	RL3522BJ-A-9	
RL3522BK-A		
	Ports: NPT3/8	
Application	Mercedes	0014318705
	Iveco	04773981
RL3522BH01		
	Ports: All M16x1.5 Predominance: 0.4bar-Adjustable	
RL3522BH02		
	Predominance: 0.5bar-Adjustable Ports: All M16x1.5	
Cross Ref.	9730025220	
Application	Scania	362424
	Mercedes	0024314205
RL3522BJ-B		
	Ports: All M16x1.5 Predominance Adjustable: Yes	
Cross Ref.	9730025390	
Alternative	AB2783, 355027013	
Application	Mercedes	0014318705
	Kogel	322799

RL3522FA	
	Pred.: 0.2bar Ports: 11, 12, 22, 41, 42=M22x1.5 Voss 43=M16X1.5 Voss
Cross Ref.	9730093000
Application	DAF 1259855 MAN 82523016015 RVI 5021170462 Evo Bus
Repair Kit	RL3522FA-9
RL3522FA01	
	Ports 43: M16x1.5 Ports 11,12,22,41,42: M22x1.5
Cross Ref.	9730090060
Application	MAN 81523016183 81523016189 Kogel 6502113
RL3522FA02	
	Ports 12,22,41,42,43: All M16x1.5
Cross Ref.	9730090110
Application	VW 2RR607423
RL3522FA03	
	Pred: 0.2bar Ports: All M16x1.5
Cross Ref.	WG9000360180/3
Application	CNHTC Howo





	RL3522FB-A	
	Pred.: 0.2bar Ports: 11, 12, 22, 41, 42=M22x1.5 Voss 43=M16x1.5 Voss	
	Cross Ref.	9730090010
	Alternative	AB2823, 355071001
Application	Mercedes	0034311305
	Kogel	332607
Repair Kit	RL3522FB-A-9	
RL3522FB-C		
Pred.: 0.2bar Ports: All M16x1.5		
Cross Ref.	9730090020	
Application	Iveco	08163008
	Volvo	3173151
Repair Kit	RL3522FB-C-9	
	RL3522FB	
	Pred.: 0.4bar Ports: All M16x1.5	
	Cross Ref.	9730090100
	Application	Scania
Repair Kit	RL3522FB-9	
	RL3522YC01	
	Ports 11,21,22,41: M22x1.5 Ports 42,43: M16x1.5 Installation hole thread: M8	
	Cross Ref.	AC596A
	Application	Mercedes

	RL3522YC02	
	Ports 11, 21,22,42: M22x1.5 Port 43: M16x1.5 Installation Hole Thread: M8	
	Cross Ref.	AC598C
	Application	RVI
	RL3522YB03	
	Ports 1, 2: 3xM22x1.5-6H Installation bolt: 4xM10	
	Cross Ref.	4712000080
	Application	DAF
	Mercedes	0014312605

Trailer Protection Valve		4.12
	RL3522YD01	
	Ports 12, 4: NPT3/8 Ports 21, 24: NPT1/2 Ports 23, 1-4, 3: NPT1/4 Installation hole: 2xΦ10	
	Cross Ref.	WA65706 SMP5080133
	Application	Trailer
	RL3522YD02	
	Ports 11/12 thread: PT3/8 Ports 21/22 thread: PT1/2 Ports 23/24/1-4 thread: PT1/4 Installation hole: Φ10	
	Cross Ref.	065706
	Application	Tractor, Trailer
	RL3522NA01	
	Description: Reservoir Ports: 3/8"PT Trailer Control: 1/2"PT Trailer Service: 1/2"PT Trailer Emergency: 1/2"PT Dash Valve: 1/4"PT	
	Cross Ref.	RKN34050
	Application	American Tractor

Trailer Protection Valve 4.12	
RL3522NA03	
Description: Reservoir Ports: 3/8"NPT Trailer Control: 1/2"NPT Trailer Service: 1/2"NPT Trailer Emergency: 1/2"NPT Dash Valve: 1/4"NPT	
Cross Ref.	RKN34050
Application	American Tractor
	RL3522NA02
Description: Tractor Control: 3/8"PT Trailer Service: 1/2"PT Trailer Emergency: 1/2"PT Dash Valve: 3/8"PT	
Cross Ref.	RKN34030
Application	American Tractor
RL3522NA04	
Description: Tractor Control: 3/8"NPT Trailer Service: 1/2"NPT Trailer Emergency: 1/2"NPT Dash Valve: 3/8"NPT	
Cross Ref.	RKN34030
Application	American Tractor

	RL3522UA01
Description: Tractor Control: 3/8"PT Trailer Service: 1/2"PT Trailer Emergency: 1/2"PT Tractor Emergency: 1/4"PT	
Cross Ref.	RKN34060
Application	American Tractor
RL3522UA02	
Description: Tractor Control: 3/8"NPT Trailer Service: 1/2"NPT Trailer Emergency: 1/2"NPT Tractor Emergency: 1/4"NPT	
Cross Ref.	RKN34060
Application	American Tractor
	RL3522UA03
Port 1, 4: NPT3/8, Port 2: NPT1/2	
Cross Ref.	KN34110
Application	Tractor

Repair Kit	Kits P/N	Repair Kit For	Cross Ref.	Application
	RL3522AH-9	RL3522AH	9730020042	Scania 282501
	RL3522BJ-9 RL3522BJ-A-9	RL3522BJ RL3522BJ-A	9730020052	MAN 961076 Iveco 8124000
	RL3522BH-9	RL3522BH	9730020062	Iveco 42486484 MAN 81521516046 Mercedes 0025865942
	RL3522FB-9 RL3522FB-A-9 RL3522FB-C-9	RL3522FB RL3522FB-A RL3522FB-C	9730090002	Scania 1338893 Mercedes 0004303706
	RL3522FA-9	RL3522FA	9730090012	DAF 1337535 MAN 82523016018

TP-3 Tractor Protection Valve 4.12	
RL3548ZA	
	Tractor Em.: 1/4"PT Tractor Ser.: 3/8"PT Trail.em.: 1/2"PT Trail.ser.: 1/2"PT
Cross Ref.	279000
Application	American Trailer
RL3548ZA01	
	Tractor Em.: 1/4"NPT Tractor Ser.: 3/8"NPT Trail.em.: 1/2"NPT Trail.ser.: 1/2"NPT
Cross Ref.	279000
Application	American Trailer
RL3548ZA02	
	Tractor Em.: 1/4"NPT Tractor Ser.: 3/8"NPT Trail.em.: 3/8"NPT Trail.ser.: 3/8"NPT
Cross Ref.	279692
Application	American Trailer
RL3548ZB	
	Tractor Em.: 1/4"NPT Tractor Ser.: 3/8"NPT Trail.em.: 3/8"NPT Trail.ser.: 3/8"NPT
Cross Ref.	279692
Application	American Trailer



TP-4 Tractor Protection Valve 4.13	
RL3522YA04	
	TES:1/4NPT,TE: 1/4NPT PCD:3/8NPT, SCD: 3/8NPT SLS:1/4NPT,TSS: 3/8NPT
Cross Ref.	288301
Application	Tractor, Trailer

TP-5 Tractor Protection Valve 4.13	
RL3548RA01	
	Trail Emerg Supply: 1/2"NPT Trail Serv Supply: 1/2"NPT Trail Serv & Emerg Supply(Rear): 3/8"NPT Trail Control: 3/8"NPT Stop Light Switch: 1/4"NPT Serv Rear: 1/4"NPT Installation: 4X5/16-18UNC
Cross Ref.	288605
Application	Tractor, Trailer





RT-4 Sealco Ratio Relay Valve 4.14	
RL3527GC	
	Ports: SUP=3/8"PT, DEL=3/8"PT RES=1/2" PT, RES=3/8"PT, CON=3/8"PT
Cross Ref.	KN26000
Application	American Trailer
RL3527GC01	
	Ports: SUP=3/8" NPT, DEL=3/8" NPT RES=1/2"NPT , RES=3/8" NPT CON=3/8" NPT Cover As Shown
Cross Ref.	KN26000
Application	American Trailer

Sealco Ratio Relay Valve 4.14	
RL3527GA	
	Ports: SUP=3/8"PT, DEL=3/8" PT RES=1/2"PT , CON=3/8" PT Cover As Shown
Cross Ref.	110170
Application	Neoplan
Repair Kit	RL3527GA-9
RL3527GA01	
	Ports: SUP=3/8"NPT, DEL=3/8" NPT RES=1/2"NPT , CON=3/8" NPT Cover As Shown
Cross Ref.	110170
Application	Neoplan
RL3527GA-A	
	Ports: SUP=3/8"PT , DEL=3/8" PT, RES=1/2"PT , RES=3/8"PT , CON=3/8"PT Cover As Shown
Cross Ref.	110315
Application	Heavy Duty Truck
Repair Kit	RL3527GA-A-9
RL3527GA04	
	Ports: SUP=3/8"NPT DEL=3/8" NPT RES=1/2"NPT RES=3/8"NPT , CON=3/8"NPT Cover As Shown
Cross Ref.	110315
Application	Heavy Duty Truck

	RL3527GB
	Ports: SUP=3/8"PT , DEL=3/8"PT RES=3/8" PT, RES=1/2"PT CON=3/8"PT Cover As Shown
Cross Ref.	110310
Application	Heavy Duty Truck
Repair Kit	RL3527GB-9
RL3527GA05	
	Ports: SUP=3/8"NPT DEL=3/8"NPT RES=3/8"NPT RES=1/2"NPT CON=3/8"NPT Cover As Shown
Cross Ref.	110310
Application	Heavy Duty Truck
RL3527GB-A	
	Ports: SUP=3/8"PT , DEL=3/8"PT RES=3/8"PT , RES=1/2"PT, CON=3/8"PT Cover Rotated By 90°
Cross Ref.	110191
Application	Heavy Duty Truck
Repair Kit	RL3527GB-A-9
RL3527GA02	
	Ports: SUP=3/8"NPT DEL=3/8"NPT RES=3/8"NPT RES=1/2"NPT CON=3/8"NPT Cover Rotated By 90°
Cross Ref.	110191
Application	Heavy Duty Truck

Sealco Ratio Relay Valve		4.14
		RL3527GA-B
	Ports: SUP=3/8"PT DEL=3/8"PT RES=1/2"PT RES=3/8"PT CON=3/8"PT Cover Rotated By 90°	
Cross Ref.	110171	
Application	Heavy Duty Truck	
Repair Kit	RL3527GA-B-9	
		RL3527GA03
	Ports: SUP=3/8"NPT DEL=3/8"NPT RES=1/2"NPT RES=3/8"NPT CON=3/8"NPT Cover Rotated By 90°	
Cross Ref.	110171	
Application	Heavy Duty Truck	

SR-2 Trailer Relay Valve		4.14
		RL3599AC
	Ports: SUP=1/4"PT, DEL=3/8"PT SER=1/4"PT RES=3/4"PT	
Cross Ref.	287376	
Alternative	9738800010	
Application	American Trailer	
		RL3599AC-A
	Ports: SUP=1/4"NPT, DEL=3/8"NPT Ser=1/4"NPT Res=3/4"NPT	
Cross Ref.	287376	
Application	American Trailer	

Trailer Spring Relay Valve		4.15
		RL3599AD
	Ser: 1/4-19PT Port Del: 4x3/8-19PT Port Sp.rbk.res: 3/4-14PT Port: 1/4-19PT Open Pressure 23: 4.5bar Open Pressure 12: 5bar	
Application	American Trailer	
		RL3599CA
	Ports: SUP, RES, SER=1/4"PT DEL=3/8"PT, RES,CON=3/4"PT	
Cross Ref.	101112	
Alternative	9738830010	
Application	American Trailer	
		RL3599CC
	Ports: SUP, RES, SER=1/4"NPT DEL=3/8"NPT, RES,CON=3/4"NPT	
Cross Ref.	101112	
Application	American Trailer	
		RL3599CB
	Ports: SUP, RES, SER=1/4"PT DEL=3/8"PT, RES,CON=1/2"PT	
Cross Ref.	101622	
Alternative	9738840010	
Application	American Trailer	
		RL3599CB-A
	Ports: SUP, RES, SER=1/4"NPT DEL=3/8"NPT, RES,CON=1/2"NPT	
Cross Ref.	101622	
Application	American Trailer	

SR-5 Trailer Spring Brake Valve 4.16	
RL3599BA	
	Ports: SUP=1/4"PT DEL=3/8"PT SER=1/4"PT RES=3/4"PT
Cross Ref.	065438
Application	American Trailer
RL3599BA-A	
	Ports: SUP=1/4"NPT DEL=3/8"NPT SER=1/4"NPT RES=3/4"NPT
Cross Ref.	065438
Application	American Trailer
RL3599BB	
	Ports: SUP=1/4"PT DEL=3/8"PT SER=1/4"PT RES=1/2"PT
Cross Ref.	065440
Application	American Trailer
RL3599BB-A	
	Ports: SUP=1/4"NPT DEL=3/8"NPT SER=1/4"NPT RES=1/2"NPT
Cross Ref.	065440
Application	American Trailer

	RL3599BC
	Ports: SUP=1/4"PT DEL=3/8"PT SER=1/4"PT RES=3/4" PT Comments:With Anli-compounding
Cross Ref.	065437
Application	American Trailer
	RL3599BC-A
	Ports: SUP=1/4"NPT DEL=3/8"NPT SER=1/4"NPT RES=3/4"NPT Comments:With Anli-compounding
Cross Ref.	065437
Alternative	9738850010
Application	American Trailer
	RL3599BD
	Ports: SUP=1/4"PT DEL=3/8"PT SER=1/4"PT RES=1/2"PT Comments:With Anli-compounding
Cross Ref.	065439
Alternative	9738850020
Application	American Trailer
	RL3599BD-A
	Ports: SUP=1/4"NPT DEL=3/8"NPT SER=1/4"NPT RES=1/2"NPT Comments:With Anli-compounding
Cross Ref.	065439
Alternative	9738850020
Application	American Trailer

SR-2 Trailer Spring Brake Valve 4.16	
RL3599AA	
	Ports: SUP=1/4"PT , Trail, SER=1/4"PT DEL=3/8"PT SER=1/4"PT RES=3/4"PT
Cross Ref.	102761
Alternative	9738810010
Application	American Trailer
RL3599AA-A	
	Ports: SUP=1/4"NPT , Trail, SER=1/4"NPT DEL=3/8"NPT SER=1/4"NPT RES=3/4"NPT
Cross Ref.	102761
Alternative	9738810010
Application	American Trailer
RL3599AB	
	Ports: SUP=1/4"PT , TRAIL, SER=1/4"PT DEL=3/8"PT SER=1/4"PT, RES=1/2"PT
Cross Ref.	9738820010, 103061
Application	American Trailer Volvo 1030-61320
RL3599AB-A	
	Ports: SUP=1/4"NPT , TRAIL SER=1/4"NPT DEL=3/8"NPT SER=1/4"NPT RES=1/2"NPT
Cross Ref.	103061
Application	American Trailer

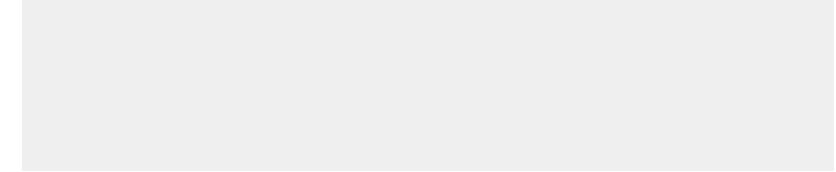

SR-1 Spring Brake Valve 4.16	
RL3599EA01	
	Supply: 1/4"PT Delivery: 1/4"PT Control: 1/4"PT Res No.1: 1/4"PT Reservoir Pressure: 55psi
Cross Ref.	286364
Application	Heavy Duty Truck
RL3599EA02	
	Supply: 1/4"NPT Delivery: 1/4"NPT Control: 1/4"NPT Res No.1: 1/4"NPT Reservoir Pressure: 55psi
Cross Ref.	286364
Application	Heavy Duty Truck



Relay Emergency Valve		4.17
RL3518EA		
		
Port Sup: RC1/2 Port Del: RC3/8 Port: RC1/4		
Application	American Trailer	
Repair Kit	RL3518EA-9	
RL3518EG		
		
Port 1: M22x1.5 Port 2: M16x1.5 Port 4: M14x1.5		
Application	American Trailer	
Repair Kit	RL3518EG-9	
RL3518EA2		
		
Ports: Sup=1/2"PT ,Del=3/8"PT Continue=1/4" PT Comments: All Variations Available Degrees Service Port Angle: 90°		
Cross Ref.	280375	
Application	Leyland,Foden,ERF,Ford	
RL3518ED01		
Ports: SUP=1/2"NPT DEL=3/8"NPT Continue=1/4" NPT Comments: All Variations Available Degrees Service Port Angle: 90°		
Cross Ref.	280375	
Application	Trailer	



RL3518EE-A	
Ports: SUP=3/4"PT,SUP=3/8"PT DEL=3/8"PT, Continue=1/4"PT Degrees Service Port Angle: 180°	
Cross Ref.	279952
Application	Trailer
RL3518ED03	
Ports: SUP=3/4"NPT,SUP=3/8"NPT DEL=3/8"NPT , Continue=1/4"NPT Degrees Service Port Angle: 180°	
Cross Ref.	279952
Alternative	9738900190
Application	Trailer
RL3518EB-B	
	
Ports: SUP=3/4"PT,SUP=3/8"PT DEL=3/8"PT , Continue=1/4"PT Degrees Service Port Angle:270°	
Cross Ref.	283940
Application	Trailer
RL3518ED02	
Ports: SUP=3/4"NPT,SUP=3/8"NPT DEL=3/8"NPT , Continue=1/4"NPT Degrees Service Port Angle: 270°	
Cross Ref.	283940
Alternative	9738900160
Application	Trailer

Relay Emergency Valve		4.17
RL3518ED		
Ports: SUP=3/8"NPT DEL=3/8"NPT Continue=1/4"NPT Degrees Service Port Angle: 180°		
Cross Ref.	279180	
Application	Trailer	
Repair Kit	RL3518ED-9	
RL3518ED04		
Supply: RC3/8 Delivery: RC3/8 Continue: RC1/4		
Cross Ref.	45300030131	
Application	Nissan	41584-Z0003
RL3527AL		
 <p>Sup: M16x1.5 Res: M14x1.5 Del Ports: M16x1.5 Port: M22x1.5</p>		
Application	Nissan	
RL3527AB		
 <p>Ports: SUP=3/4" NPT RES=3/8"NPT All Other 1/4"NPT</p>		
Cross Ref.	281860	
Application	Trailer	
Repair Kit	RL3527AB-9	

RL3527AC		
Ports: SUP=3/4" NPT RES=3/8"NPT DEL: 3/8"NPT EM+SER 1/4"NPT		
Cross Ref.	281672	
Alternative	9710050000	
Application	Trailer	
RL3527AD		
Ports: SUP=3/4" NPT RES=3/8"NPT DEL 2X1/4"NPT +2X3/8"NPT EM+SER 1/4"NPT		
Cross Ref.	281865	
Alternative	9710050000	
Application	Trailer	
Repair Kit	RL3527AD-9	
RL3527DB		
 <p>Ports: All Ports M22x1.5 Comment: Fixed At 0 bar</p>		
Cross Ref.	9710023070	
Application	DAF	1518259
	MAN	N2509990164
	RVI	5021208564
Repair Kit	RL3527DB-9	
RL3527DA		
 <p>Ports: 4=M22x1.5 All Others M22x1.5 Comment: Adjustable 0 to1</p>		
Cross Ref.	9710023040	
Application	DAF	1519300
	MAN	N2509990162
Repair Kit	RL3527DA-9	

Relay Emergency Valve 4.17	
	RL3527DF
	Ports: 4=M16x1.5 All Others M22x1.5 Comment: Adjustable 0 To1
Cross Ref.	9710023000
Application	DAF 1359971 MAN N2521160024 RVI 5021208761 Krone 58111590 Kogel 336489 Schmitz 052504 82839440002
Repair Kit	RL3527DF-9
	RL3527DE07
	Port: M22x1.5, M16x1.5 Installation hole: M8
Cross Ref.	9710028050
Application	DAF 1664345 MAN N2509990166 RVI 5021170448 Scania 1738442 Krone 5870375 Kogel 6500287

Relay Emergency Valve With Release 4.17	
	RL3527DD
	Combination Of RL3527DF+RL3520ZA Comment: Fixed At 0bar
Cross Ref.	9710027000
Application	DAF 1519310
Repair Kit	RL3527DD-9

	RL3527DE
	Combination Of RL3527DF+RL3520ZB Comment: Fixed At 0 bar
Cross Ref.	9710027010
Application	DAF 1519312
Repair Kit	RL3527DE-9
	RL3518NA
	Combination Of RL3518NB+RL3520AC Comment: Adjustable (0-1.0) bar
Cross Ref.	9710025300
Application	DAF 815808
Repair Kit	RL3518NA-9
	RL3518ND
	Combination Of RL3518NB+RL3520ZB Comment: Adjustable 0-1.0 bar
Cross Ref.	9710025310
Alternative	AS3100, 350026002
Application	DAF 1325333 Neoplan 07111000
	RL3518NE
	Combination Of RL3518NC RL3520ZB Comment: Fixed At 0 bar
Cross Ref.	9710025470
Application	DAF 1519305 RVI 5000809875

Relay Emergency Valve With Release 4.17		
		RL3518NF
Ports 1,2,1-2,4: M22x1.5 Comments: Combination Of 9710021500 And Manual 4756040110 =RL3518NB+RL3520AB Predominance: Adjustable: 0 To 1		
Cross Ref.	9710025700	
Application	DAF	1518260
	Neoplan	07101000

Relay Emergency Valve 4.17		
		RL3518MA
Ports:1-2=M22,2=4xM16+2xM22 Port 4=M16		
Cross Ref.	9710021520	
Application	DAF	1325335
	MAN	N2521160023
	Neoplan	07110000
	Krone	945017
	Kogel	76275
	Schmitz	050024
Repair Kit	RL3518MA-9	



		RL3518MB
Ports:1-2=M22x1.5 All Others: M16x1.5 Comment: Adjustable 0 bar To 1 bar		
Cross Ref.	9710021510	
Application	DAF	1519296
	RVI	5021170442
Repair Kit	RL3518MB-9	

		RL3518NB
Ports: All Ports M22x1.5 Pred.: 0bar		
Cross Ref.	9710021500	
Alternative	AS3000, 201005001	
Application	AF	1506643
	Neoplan	07110000
	Krone	58106060
	Kogel	79810
Repair Kit	RL3518NB-9	

		RL3518NC
Ports: All Ports M22x1.5 Pred.: 0 bar		
Cross Ref.	9710020000	
Alternative	AS3000	
Application	DAF	1518257
	Iveco	09988413
	RVI	0001108600
	Volvo	11018647
Repair Kit	RL3518NC-9	

		RL3527UA01
Reser Vatorio: 1/2NPT Saída: 1/4NPT Emerg: 1/4NPT Service: 1/4NPT		
Cross Ref.	950100	
Application	Carretas Trailer	





		RL3527UA02
Supply: NPT1/2, M22x1.5 Delivery: 3xM16x1.5 Emerg: M16x1.5 Service: M16x1.5		
Cross Ref.	951400	
Application	Carretas Trailer	

Relay Emergency Valve		4.17
		RL3527FA
	Supply: 3/4"NPT Delivery: 4x3/8"NPT Emerg: 2x1/4"NPT Service: 3/8"NPT Crack Pressure: 4.5psi	
Cross Ref.	110460	
Application	American Trailer	
Repair Kit	RL3527FA-9	
		RL3527FB
		Supply: 3/4"NPT Delivery: 4x3/8"NPT Emerg: 2x1/4"NPT Service: 1/4"NPT Crack Pressure: 4.5psi
Cross Ref.	110200	
Application	American Trailer	
Repair Kit	RL3527FB-9	
		RL3527FC
		Supply: 3/48" NPT Delivery: 4x3/8"NPT Emerg: 2x3/8" NPT Service: 3/8"NPT
Cross Ref.	110205	
Application	American Trailer	
Repair Kit	RL3527FC-9	
		RL3527FB01
	Supply: M22x1.5 Delivery: 4xM16x1.5 Emerg: 2xM14x1.5 Service: M16x1.5	
Application	American Trailer	



Ratio Relay Valve		4.17
		RL3527FD
	Supply: 1x3/8"NPT Reservoir: 1x3/4"NPT Delivery: 4x3/8"NPT	
Cross Ref.	110139	
Application	American Trailer	
Repair Kit	RL3527FD-9	







Relay Emergency Valve		4.17
		RL3527KA
	Ports 1, 4: M16x1.5 Ports 1-2, 2: M22x1.5	
Cross Ref.	950364104	
Application	DAF	1446687
	MAN	2035185
Repair Kit	RL3527KA-9	
		RL3527MA
	Ports: SUP=3/4"PT DEL=2X3/8"PT CON=1/4" PT EMERG=3/8"PT	
Cross Ref.	KN12352	
Application	American Truck	
		RL3527MA02
		Ports: SUP=3/4"NPT DEL=2X3/8"NPT CON=1/4" NPT EMERG=3/8"NPT
Cross Ref.	KN12352	
Application	American Truck	





Mini Relay Valve		4.17
		RL3518QA
	Ports: SUP=3/8"NPT DEL=1/4"NPT CONT=1/4"NPT	
Cross Ref.	3100	
Application	American Trailer	
Repair Kit	RL3518QA-9	
		RL3518QP01
	Supply: 1/2"PT Delivery: 1/4"PT Control: 1/4"PT Emerg Supply: 1/4"PT	
Cross Ref.	A1000	
Application	American Trailer	
		RL3518QP02
	Supply: 1/2"NPT Delivery: 1/4"NPT Control: 1/4"NPT Emerg Supply: 1/4"NPT	
Cross Ref.	A1000	
Application	American Trailer	
		RL3518QB01
	Supply: 1-1/2"NPT Delivery: 2-3/8"NPT Control: 3/8"NPT	
Cross Ref.	110197	
Application	American Trailer	

Release Valve		4.18
		RL3520AC
	Ports: 1=M22X1.5, 2=Flange	
Cross Ref.	9630010010	
Alternative	AE4214, 352001001	
Application	DAF	0736144
	Evobus	8283706000
		RL3520ZA
	Ports: 1=M22X1.5, 2=φ21.5	
Cross Ref.	9630010130	
Alternative	AE4214, 352012001	
Application	DAF	1325328
	MAN	82523106008
	BPW	8.283.706.000
Repair Kit	RL3520ZA-9	
		RL3520ZA05
	Ports: All M16x1.5 Hand Shaft: Red	
Cross Ref.	9630060030	
Application	DAF	0867882
	Hino	
		RL3520ZB
	Ports: 1=M16X1.5, 2=φ21.5	
Cross Ref.	9630010120	
Alternative	AE4215	
Application	DAF	1325329
	RVI	5000809163
Repair Kit	RL3520ZB-9	



Release Valve		4.18
RL3520ZC		
	Ports: All M16x1.5	
Cross Ref.	9630060010	
Alternative	AE4200, 207002001	
Application	RVI	5021170428
	MAN	1065271
	Iveco	8193547
Repair Kit	RL3520ZC-9	
RL3520ZD01		
	Ports=M16x1.5 Installation Hole: M8	
Cross Ref.	9630010520	
Application	DAF	1506449
	MAN	N2509990158
	RVI	5021170427
RL3520ZD02		
	Ports=M16x1.5 Installation Hole: M8 Inside Has Check Valve	
Cross Ref.	9630010510	
Application	DAF	1506448
	Neoplan	07133000
	Krone	58124230
	Kogel	336490
	Schmitz	052190
		8283012000

RL3520ZD03		
	All Ports Thread: M16x1.5 Installation Hole Thread: M8	
Cross Ref.	9630010500	
Application	DAF	
	Scania	1802800
	RVI	5051170426
RL3548SA		
	All Ports Thread: NPT 1/4 Installation Hole: ϕ 7	
Cross Ref.	800516	
Application	American Trailer	

Repair Kits	Kits P/N	Repair Kit For	Cross Ref.	Application
	RL3527GA-9 RL3527GB-9 RL3527GA-A-9 RL3527GA-B-9 RL3527GB-A-9	RL3527GA RL3527GB RL3527GA-A RL3527GA-B RL3527GB-A		Heavy Duty Truck
	RL3527DA-9 RL3527DF-9 RL3527DB-9	RL3527DA RL3527DF RL3527DB	9710020082	Trailer
	RL3527AB-9 RL3527AD-9	RL3527AB RL3527AD	282812	American Trailer
	RL3527DD-9 RL3527DE-9	RL3527DD RL3527DE	9710020082 9630060002	
	RL3518NA-9	RL3518NA		DAF 0832865
	RL3518MA-9 RL3518MB-9	RL3518MA RL3518MB	9710020042	DAF 1506472
	RL3518NB-9	RL3518NB	9710020032	DAF 0832865





Repair Kits	Kits P/N	Repair Kit For	Cross Ref.	Application
	RL3518NC-9	RL3518NC	9710020062	DAF 1506475 Iveco 93161510 Volvo 11706487
	RL3527FA-9 RL3527FB-9 RL3527FC-9	RL3527FA RL3527FB RL3527FC		American Trailer
	RL3527KA-9	RL3527KA		
	RL3520ZA-9 RL3520ZB-9 RL3520ZC-9	RL3520ZA RL3520ZB RL3520ZC	9630060002	Iveco 08124486
	RL3518QA-9	RL3518QA		American Trailer



Anti-Compound Valve		4.19
RL3518KA		
	Ports 1,2,3: M22x1.5 Ports 41,42: M22x1.5	
RL3518KA01		
	Ports 1,2,3: M22x1.5 Ports 41,42: M22x1.5	
Cross Ref.	4730170010	
Alternative	355062001, RE2224	
Application	Iveco	3506500595
	MAN	81521506012
	Mercedes	0034297844
	Neoplan	11017336
RL3518KA-A		
	Ports: All Ports M22x1.5	
Cross Ref.	4730170080	
Application	Mercedes	0014292144
	Iveco	04672022
	Neoplan	110242500
	RVI	24733006
RL3518KH		
	Ports: All Ports M22x1.5	
Cross Ref.	4730170070	
Application	Mercedes	





RL3518KM		
	Ports: All Ports M22x1.5 Comment: Hose Nipple Exhaust	
Cross Ref.	4730170050	
Application	Iveco	08120458
	Evobus	8283789000
Repair Kit	RL3518KM-9	
RL3518KA02		
	Inlet Port 1: M22x1.5 Outlet Ports 21,22: M22x1.5 Control Port 4: M22x1.5	
Cross Ref.	1115035600033	
Application	Foton Auman 6 Series Root Van (BJ1317vnpjj-19) Foton Auman Dump (BJ3258dlpjb-19)	
RL3518KG-A		
	Ports: All Ports M22x1.5	
Cross Ref.	6125G02-3518020	
Application	Yutong	3527-00041
	XiaMen King Long	1417335628002

Relay Valve		4.20
RL3518AC		
	Ports 1,2: M22x1.5 Port 4: M16x1.5	
Application	Foton, North Benz KX3518015-10	





Relay Valve		4.20
	RL3518AM Ports 1,2,4: M16x1.5	
	RL3518AF-A Ports: 1=M22, 2, 4=M22 Comment: Sanp On Exhaust	
Cross Ref.	9730010180	
Application	Truck	
	RL3518AH Ports: 1=M22x1.5, 2, 4=M22x1.5	
Cross Ref.	9730010100	
Alternative	RE1105, 355018011	
Application	MAN	81436096008
	Iveco	1278511
Repair Kit	RL3518AH-9	
	RL3518AK Ports: 1=M22x1.5, 2, 4=M16x1.5	
Cross Ref.	9730010200	
Alternative	AE4100, 355018071	
Application	Iveco	04464164
	MAN	81521166010
	Mercedes	0004293044
Repair Kit	RL3518AK-9	
	RL3518AY Ports: 1=M22x1.5, 2,3,4=M22x1.5	
Cross Ref.	9730010130	
Alternative	RE1105, 355018011	
Application	MAN	81436096008
	Iveco	2444906

	RL3518AH01 Ports 1,2 : M16x1.5 Port4: M22x1.5	
	RL3518AH02 Port1: 3/8NPT Port2: 1/2NPT Port4: 1/4NPT	
Cross Ref.	9730010190	
Application	VW	12140
	Ford	B1618, C1514
	RL3518AZ Ports: 1, 2=M22, 4=M16, 3=M22 Comment: Fast Response	
Cross Ref.	9730012110	
Application	DAF	1505410
	Mercedes	003429134
Repair Kit	RL3518AZ-9	
	RL3518AZ-A Port 1: M22x1.5 Port 2: M22x1.5 Port 4: M16x1.5 Port 3: M22x1.5 Degrees Port4 Angle: 180°	



Relay Valve		4.20
RL3518ZH		
	Ports: 1, 2=M22. 4=M16 Comment: With Muffler	
Cross Ref.	9730110040	
Application	Mercedes	0044296244
	DAF	1305026
	Volvo	
RL3518ZA		
	Ports: 1, 2=M22x1.5, 4=M16x1.5	
Cross Ref.	9730110000	
Alternative	1186715, 201004001	
Application	Scania	1322986
	RVI	24733005
	Volvo	1082666
	MAN	4047273
	Iveco	3307710r91
Repair Kit	RL3518ZA-9	
RL3518ZB-A		
	Ports: 1, 2=M22x1.5 Voss 4=M16x1.5 Voss	
Cross Ref.	9730110010	
Alternative	RE1115	
Application	Mercedes	0044293844
	JAC HCV Gallop, Tilpper	
RL3518ZF		
	Ports: 1, 2=1/2" NPT, 4=1/4" NPT	
Cross Ref.	9730110050	
Application	Scania	1425183

	RL3518ZA02	
	Port: 1=M22X1.5,2,4=M16X1.5	
RL3518ZA06		
	Port 1: M22x1.5 Ports 2,4: M16x1.5 Installation bolt: 4xM8	
	RL3518ZA04	
	Port 1: 3/8NPT Port 2: 1/2NPT Port 4: 1/4NPT	
Cross Ref.	8845022560	
Application	VW	2RG607408A
	RL3518ZA05	
	Port 1: M22x1.5 Voss Port 2: M22x1.5 Voss Port 4: M16x1.5 Voss	
Cross Ref.	9730110070	
Application	Mercedes	3864297044
	RL3518ZA07	
	Ports thread M22x1.5, M16x1.5 Installation bolt: 4xM8	
Cross Ref.	9730112060	
Application	DAF	1518270
	RVI	5010260705
	Volvo	25328737
	RL3518ZA77	
	Port 1: M22x1.5 Ports 21,22 : M16x1.5	
Cross Ref.	9730110500	
Application	DAF	1504903
	MAN	ZG046560002
	Scania	1342598

Relay Valve		4.20	
		RL3518ZD	
		Quick Connector 1,2φ15 Quick Connector 4φ10	
Application	FAW	3518010-348	3518010-418
		RL3518AE01	
		Ports 1, 21, 22 thread: M22x1.5 Port 4 thread: M16x1.5	
Cross Ref.	9730060010		
Application	DAF	1505150	
	MAN	81521166067	
	Mercedes	0044290644	DP002130
		RL3518AD01	
		Ports 1, 2 thread: M22x1.5 Port 4 thread: M16x1.5 Installation hole: φ8.6	
Cross Ref.	0481026303000		
Application	Evobus Axor		
	MAN	81521166074	
	Mercedes	0044296344	
		RL3518ZA01	
		Ports: 1 M22x1.5 21,22: M16x1.5 41,42: M16x1.5	
Cross Ref.	9730112010		
Application	DAF	1519332	
	MAN	ZG046570002	
	Krone	5818121	
	Kogel	6501083	

		RL3518ZE	
		Ports 1, 2: M22x1.5 Voss Ports 41, 42: M16x1.5 Voss Comment: With Muffler	
Cross Ref.	9730112050		
Application	DAF	1302103	
	Iveco	5010207451	
	Mercedes	0054291044	
	RVI	5010207451	
Repair Kit	RL3518ZE-9		
		RL3518ZE-A	
		Ports 1, 2: M22x1.5 Ports 41, 42: M16x1.5	
Cross Ref.	9730112030		
Application	Iveco	41025604	
Repair Kit	RL3518ZE-A-9		
		RL3518ZE-B	
		Ports 1, 2: M22x1.5 Voss Ports 41 42: M16x1.5 Voss	
Cross Ref.	9730112000		
Application	DAF	1259856	
	Iveco	5010206016	
	MAN	81521166071	
	Mercedes	0044297644	
	JAC HCV Gallop, Tilpperl		
		RL3518GB	
		 Ports: Sup 1+2=3/8"NPT, Del=3/8"NPT Con=1/4"NPT Crack Pressure: 5.6 psi Control Pos: 90	
Cross Ref.	KN28500		
Alternative	9732880080		
Application	Trailer		
Repair Kit	RL3518GB-9		

RG-2 Relay Valve		4.20
RL3518GG		
	Ports: Sup 1=1/2"NPT, Sup 2=3/8"NPT Del 3/8"NPT, Con=1/4"NPT Crack Pressure: 5.6 psi Control Pos: 90°	
Cross Ref.	KN28510	
Application	Trailer	
Repair Kit	RL3518GG-9	
RL3518GG-A		
	Ports: Sup 1=3/8"NPT, Sup 2=1/2"NPT Del=3/8"NPT Con=1/4"NPT Crack Pressure: 5.6 psi Control Pos: 0°	
Cross Ref.	KN28531	
Application	Trailer	
Repair Kit	RL3518GG-A-9	
RL3518GH		
	Ports: Sup 1+2=1/2"NPT, Del=1/2"NPT Con=1/4"NPT Crack Pressure: 5.6 psi Control Pos: 90°	
Cross Ref.	KN28520	
Application	Trailer	
Repair Kit	RL3518GH-9	
RL3518GL		
	Port 1: M22x1.5 Port 2: M16x1.5 Port 4: M14x1.5	
Cross Ref.	IA236505	

RL3518AC01	
	Ports 1, 2 thread: M22x1.5 Port 4 thread: M16x1.5 Installation hole: ϕ 8.5
Cross Ref.	AC577A
Application	DAF, Leyland F65, Mercedes 1313 Foden Alpha, Irisbus Iveco SPR1, RVI Scania 4 Series Truck
RL3518HC01	
	Port 1: RC1/2 Port 2: RC1/ 2 Port 4: RC1/ 4

R-12 Relay Valve		4.20
RL3518HS		
	Supply: 1/2" PT Delivery: 3/8" PT Service: 1/4" PT Crack Pressure: 4 psi	
Cross Ref.	065303	
Application	Van Horn Truck	
RL3518HC03		
	Supply: 1/2"NPT Delivery: 3/8"NPT Service: 1/4"NPT Crack Pressure: 4 psi	
Cross Ref.	065303	
Application	Van Horn Truck	

R-12 Relay Valve		4.20
RL3518HC-B		
		
Ports: Sup=3/4"RC Del=1/2"RC ,Con=1/4"RC Crack Pressure: 4.0 psi		
Cross Ref.	103009	
Alternative	9732860010	
Application	American Trailer	
Repair Kit	RL3518HC-B-9	
RL3518HC02		
Ports: Sup=3/4"NPT Del=1/2"NPT, Con=1/4" NPT Crack Pressure: 4.0 psi		
Cross Ref.	103009	
Alternative	9732860010	
Application	American Trailer	
RL3518HC-A		
Ports: Sup=1/2"RC Del=1/2" RC ,Con=1/4"RC Crack Pressure: 5.5 psi		
Cross Ref.	065125	
Application	American Trailer	
RL3518HC04		
Ports: Sup=1/2"NPT Del=1/2"NPT , Con=1/4"NPT Crack Pressure: 5.5 psi		
Cross Ref.	065125	
Application	American Trailer	

RL3518HC-C	
Ports: Sup=1/2"PT Del=1/2"PT ,Con=1/4"PT Crack Pressure: 4.0 psi	
Cross Ref.	065309
Application	American Trailer
RL3518HC06	
Ports: Sup=1/2"NPT Del=1/2"NPT, Con=1/4"NPT Crack Pressure: 4.0 psi	
Cross Ref.	065309
Application	American Trailer
RL3518HG-A	
Ports: Sup=3/4"RC Del=1/2" RC , Con=1/4"RC Crack Pressure: 7.5 psi	
Cross Ref.	104165
Application	American Trailer
Repair Kit	RL3518HG-A-9
RL3518HC05	
Ports: Sup=3/4"NPT Del=1/2"NPT, Con=1/4"NPT Crack Pressure: 7.5psi	
Cross Ref.	104165
Application	American Trailer

Relay Valve		4.20
		RL3518HC07
		Port 1: NPT1/2 Port 2: NPT1/2 Port 4: NPT1/4 Cut-off Pressure: 4.0psi

R-14 Relay Valve		4.20
		RL3518JB-A
		Ports: Sup=1/2"RC Del=1/2" RC Con=1/4"RC Balance =1/8"RC Crack Pressure: 4.0 psi
Cross Ref. Alternative Application Repair Kit	103028 9732870010, 9732880010 Universal RL3518JB-A-9	
		RL3518JC12
		Ports: Sup=1/2"NPT , Del=1/2"NPT Con=1/4"NPT , Balance =1/8"NPT Crack Pressure: 4.0 psi
Cross Ref. Alternative Application	103028 9732870010, 9732880010 Universal	
		RL3518JB-B
		Ports: Sup=1/2"RC, Del=1/2"RC Con=1/4" RC, Balance =1/8" RC Crack Pressure: 7.5 psi
Cross Ref. Application	103833 American Trailer	

		RL3518JC13
		Ports: Sup=1/2"NPT, Del=1/2"NPT Con=1/4"NPT, Balance =1/8"NPT Crack Pressure: 7.5 psi
Cross Ref. Application	103833 American Trailer	
		RL3518JB-C
		Ports: Sup=1/2" Rc,Del=1/2" RC, Con=1/4"RC Balance=1/8"RC Crack Pressure: 5.5 psi
Cross Ref. Application	106313 American Trailer	
		RL3518JC14
		Ports: Sup=1/2"NPT, Del=1/2"NPT Con=1/4" NPT , Balance =1/8"NPT Crack Pressure: 5.5 psi
Cross Ref. Application	106313 American Trailer	

R-12 Relay Valve		4.20
		RL3518JC
		Ports: Sup=1/2"PT, Del=1/2"PT Con=1/4"PT Crack Pressure: 4.0 psi
Cross Ref. Alternative Application Repair Kit	102626 9732850010 TATA RL3518JC-9	

R-12 Relay Valve		4.20
		
RL3518JC02		
Ports: Sup=1/2"NPT Del=1/2"NPT ,Con=1/4"NPT Crack Pressure: 4.0 psi		
Cross Ref.	102626	
Application	American Trailer	
RL3518JC-B		
Ports: Sup=1/2"PT Del=1/2"PT, Con=1/4"PT Crack Pressure: 7.5 psi		
Cross Ref.	103912	
Application	American Trailer	
RL3518JC05		
Ports: Sup=1/2"NPT Del=1/2"NPT , Con=1/4"NPT Crack Pressure: 7.5 psi		
Cross Ref.	103912	
Application	American Trailer	
RL3518JL-B		
Ports: Sup=1/2"PT Del=3/8"PT , Con=1/4"PT Crack Pressure: 38 psi		
Cross Ref.	104561	
Application	American Trailer	

RL3518JC06	
Ports: Sup=1/2"NPT Del=3/8"NPT , Con=1/4" NPT Crack Pressure: 38 psi	
Cross Ref.	104561
Application	American Trailer
RL3518JL-A	
Ports: Sup=1/2"PT Del=3/8"PT ,Con=1/4"PT Crack Pressure: 4 psi	
Cross Ref.	065104
Application	American Trailer
RL3518JC04	
Ports: Sup=1/2"NPT, Del=3/8"NPT Con=1/4" NPT Crack Pressure: 4 psi	
Cross Ref.	065104
Application	American Trailer
RL3518JC-A	
Ports: Sup=1/2"PT, Del=1/2" PT Con=1/4"PT Crack Pressure: 5.5 psi	
Cross Ref.	065181
Application	American Trailer

R-12 Relay Valve		4.20
RL3518JC07		
		
Ports: Sup=1/2" NPT Del=1/2"NPT, Con=1/4"NPT Crack Pressure: 5.5 psi		
Cross Ref.	065181	
Application	American Trailer	



R-14 Relay Valve		4.20
RL3518JH-A		
		
Ports: Sup=3/4"RC, Del=1/2"RC Con=1/4"RC, Balance =1/8"RC Crack Pressure: 4.0 psi		
Cross Ref.	103010	
Application	American Trailer	
Repair Kit	RL3518JH-A-9	
RL3518JC03		
Ports: Sup=3/4"NPT, Del=1/2"NPT Con=1/4"NPT, Balance =1/8"NPT Crack Pressure: 4.0 psi		
Cross Ref.	103010	
Application	American Trailer	
RL3518JH-B		
Ports: Sup=3/4"RC , Del=1/2"RC Con=1/4"RC, Balance =1/8"RC Crack Pressure: 5.5 psi		
Cross Ref.	103294	
Application	American Trailer	
Repair Kit	RL3518JH-B-9	



RL3518JC08	
Ports: Sup=3/4"NPT, Del=1/2"NPT Con=1/4"NPT, Balance =1/8"NPT Crack Pressure: 5.5 psi	
Cross Ref.	103294
Application	American Trailer
RL3518JH-C	
Ports: Sup=3/4"RC, Del=1/2"RC Con=1/4"RC, Balance =1/8"RC Crack Pressure: 7.5 psi	
Cross Ref.	103835
Application	American Trailer
Repair Kit	RL3518JH-C-9
RL3518JC09	
Ports: Sup=3/4"NPT, Del=1/2"NPT Con=1/4"NPT, Balance =1/8"NPT Crack Pressure: 7.5 psi	
Cross Ref.	103835
Application	American Trailer
RL3518JH-D	
Ports: Sup=3/4"RC, Del=1/2"RC Con=1/4"RC, Balance =1/8"RC Crack Pressure: 5.0 psi	
Cross Ref.	104345
Application	American Trailer

R-14 Relay Valve		4.20
		RL3518JC10
	Ports: Sup=3/4"NPT, Del=1/2"NPT Con=1/4"NPT, Balance =1/8" NPT Crack Pressure: 5.0 psi	
Cross Ref.	104345	
Application	American Trailer	
		RL3518JK-A
		Ports: Sup=3/4"RC, Del=1/2" Rc Con=1/4"RC, Balance =1/8"RC Crack Pressure: 4.0 psi
Cross Ref.	104574	
Application	American Trailer	
		RL3518JC11
		Ports: Sup=1/2"NPT, Del=1/2" NPT Con=1/4"NPT, Balance =1/8"NPT Crack Pressure: 4.0 psi
Cross Ref.	104574	
Application	American Trailer	

R-8 Relay Valve		4.20
		RL3518SS01
	Supply: 2x3/4"PT Delivery: 1/2"PT Delivery: 1/4 PT Service: 1/4"PT Exhaust: 1/8"PT	
Cross Ref.	286370	
Application	American Trailer	



		RL3518SS04
		Supply: 2x3/4"NPT Delivery: 1/2"NPT Service: 1/4"NPT Exhaust: 1/8"NPT
Cross Ref.	286370, 288221	
Application	American Trailer	

R-8P Relay Valve		4.20
		RL3518SS02
	Description: Supply: 2x3/4"PT Delivery: 1/2"PT Delivery: 1/4"PT Service: 3/8"PT	
Cross Ref.	287114	
Application	American Trailer	
		RL3518SS03
		Description: Supply: 2x3/4"NPT Delivery: 1/2"NPT Delivery: 1/4"NPT Service: 1/4"NPT
Cross Ref.	287114	
Application	American Trailer	
		RL3518SS05
	Supply: 3/4NPT Delivery: 1/2NPT, 1/4NPT Service: 3/8NPT	
Cross Ref.	107455	
Application	American Truck	

Relay Valve		4.20
RL3518JC01		
	Port: RC1/2 Port: RC1/4 Port: RC1/8	
Application	American Truck	
RL3518LE-A		
	Ports: RES=3/4" NPT DEL, SER, EM=1/4"NPT	
Cross Ref.	KN30100	
Application	American Trailer	
Repair Kit	RL3518LE-A-9	
RL3518LE-B		
	Ports: RES=3/4"NPT DEL, SER, EM=3/8"NPT AUX Reservoir: 3/8"NPT	
Cross Ref.	KN30200	
Application	American Trailer	
Repair Kit	RL3518LE-B-9	
RL3518LE-D		
	Ports: RES=3/4"NPT DEL, SER, EM=1/4"NPT	
Cross Ref.	KN30300	
Application	American Trailer	

		RL3518LE-C
		Ports: RES=3/4"NPT DEL=3/8" NPT SER, EM=1/4" NPT
Cross Ref.	KN30400	
Application	American Trailer	
		RL3518LE-E
	Intake Port thread: NPT3/4 Output Port thread: NPT3/8 Service Port thread: NPT1/4	
Cross Ref.	AF103600	
Application	Tractor, Trailer	
		RL3518SK01
	Port1: M22x1.5 Port2: M22x1.5 Port4: M16x1.5	
Cross Ref.	AC574AXY	
Application	RVI	
		RL3518SK02
	Port 1: ϕ 15 Port 2: ϕ 15 Port 4: ϕ 10 Installation Thread: 4xM8	
Cross Ref.	AC574BYW	
Application	RVI	5010525558

Relay Valve		4.20
	RL3518ST	
	Ports: SUP=M20x1.5, DEL=φ20 Continue=G3/8	
Cross Ref.	11100	
Application	American Trailer	
	RL3518TA	
	Ports: SUP=1/2"NPT DEL=1/2"NPT CON=3/8"NPT	
Cross Ref.	KN28300	
Application	American Trailer	
	RL3518TA-A	
	Port 1: NPT1/2 Port 2: NPT3/8 Port 4: NPT3/8	
Cross Ref.	KN28060	
Application	American Tractor, Trailer	
	RL3518TB	
	Supply: 2x1/2"PT Delivery: 4x3/8"PT Control: 1x3/8"PT Crack Pressure: 70psi	
Cross Ref.	KN28080	
Application	American Trailer	

	RL3518TC02	
	Supply: 2x1/2"NPT Delivery: 4x3/8"NPT Control: 3/8"PT Crack Pressure: 70psi	
Cross Ref.	KN28080	
Application	American Trailer	
	RL3518TC	
	Supply: 1x1/2"PT Delivery: 2x1/2"PT Control: 1x1/4"PT, 1x1/8"PT Crack Pressure: 4 psi	
Cross Ref.	KN28071	
Application	American Trailer	
	RL3518TC01	
	Supply: 1x1/2"NPT Delivery: 2x1/2"NPT Control: 1x1/4"NPT, 1x1/8"NPT Crack Pressure: 4 psi	
Cross Ref.	KN28071	
Application	American Trailer	
	RL3518UA01	
	Supply: 3/4NPT Delivery: 3/8NPT Control: 3/8NPT Crack Pressure: 4.0psi	
Cross Ref.	110415	
Application	American Truck, Trailer	



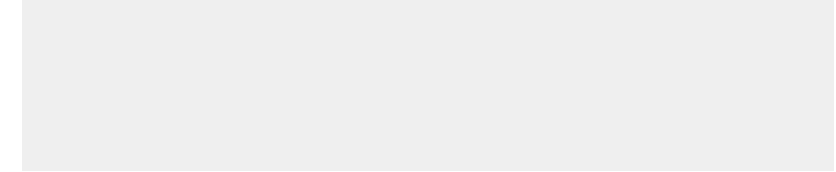

BP-R1 Relay Valve		4.20
RL3518TF		
	Ports: SUP=1/2"PT DEL=3/8"PT DEL=1/2"PT CON=1/8 "PT SER=1/4"PT Crack Pressure: 4 psi	
Cross Ref.	065145	
Application	American Trailer	
RL3518TF05		
	Ports: SUP=1/2"NPT DEL=3/8"NPT DEL=1/2"NPT CON=1/8"NPT SER=1/4"NPT Crack Pressure: 4 psi	
Cross Ref.	065145	
Application	American Trailer	
RL3518TF-C		
	Ports: SUP=1/2"PT DEL=3/8" PT DEL=1/2"PT CON=1/8 "PT SER=1/4 "PT Crack Pressure: 5.5 psi	
Cross Ref.	065146	
Application	American Trailer	
RL3518TF06		
	Ports: SUP=1/2"NPT DEL=3/8"NPT DEL=1/2"NPT CON=1/8"NPT , SER=1/4"NPT Crack Pressure: 5.5 psi	
Cross Ref.	065146	
Application	American Trailer	



Relay Valve		4.20
RL3518GB01		
	Port 1,2: ϕ 15 Port 4: ϕ 10	
Application	India Truck	
RL3518GB02		
	Port 1: ϕ 15 Port 21: ϕ 15 Port 4: ϕ 10	
Cross Ref.	M305850	
Application	India Truck	
RL3518GB03		
	Port 1: ϕ 15 Port 21: ϕ 15 Port 4: ϕ 10	
Cross Ref.	M305840	
Application	India Truck	
RL3518GB04		
	Port 1: M22x1.5 Port 2: M18x1.5 Port 4: M14x1.5	
Cross Ref.	M304930	
Application	India Truck	









Relay Valve		4.20
RL3518RA		
	Ports: SUP=M24X1.5 DEL=M24X1.5 CONT=1/4" NPT	
Application	Hino	44540-1010
RL3518RB		
	Ports: SUP=M24x1.5 DEL=M24x1.5 CONT=1/4" NPT	
Application	Nissan	45184-90010
RL3518RC		
	Ports: SUP=1/2" NPT DEL=1/2" NPT CONT=3/8" NPT	
Application	Mitsubishi	ME 707196
RL3518RD01		
	Ports 11,12: NPT1/2 Ports 21,22: NPT1/2 Port 4: NPT3/8	
Application	Japanese Trailer	

RL3518RD		
	Port 1: M20x1.5 Port 2 : Φ20.5 Port 4 : 3/8" NPT	
Application	Japanese Trailer	
RL3518RD02		
	Port 1: M20x1.5 Port 2: Φ20.5 Port 4: NPT3/8	
Application	Japanese Trailer	
RL3518RD-A		
	Ports: 3xNPT1/2 Ports: NPT3/8	
Application	Japanese Trailer	
RL3518BA		
	Port 1: NPT3/8 Port 2: NPT3/8 Port 4: NPT3/8	
Cross Ref.	EQ153	
Application	DongFeng	3527D2-010

Relay Valve		4.20
RL3518AA		
	Inlet Port 1: M22x1.5 Outlet Port 2: M22x1.5 Control Port 4: M22x1.5	
Cross Ref.	1417035600091 3527AD-010	
Application	Camc Bulk Cement Trans Portation Truck Camc Cargo Truck Foton Auman 6 Series Root Van(bj1317vnpjj-19) Foton Auman Dump (BJ3258dlpjb-19)	
RL3518BA57		
	Inlet Port 11: M16x1.5 Outlet Ports 21,22: M18x1.5 Control Port 4: M16x1.5	
Cross Ref.	13032356M0087	
Application	Foton Rowor III -190	
RL3518BA-C		
	All Ports: NPT3/8	
Cross Ref.	35GC2-27010	
Application	SuZhou King Long	
RL3518BC-L		
	Inlet Port 1: M18x1.5-6H Outlet Port 21: M18x1.5-6H Check Valve Outlet Port 22: M16x1.5-6H Control Port 4: NPT3/8	
Cross Ref.	13076356X0168	
Application	Foton Rowor P140	



RL3518CA	
	Port 1: NPT3/8 Port 2: NPT3/8 Port 4: NPT3/8
Application	ZhongWei
RL3518FZ	
	Inlet Port: M22x1.5 Outlet Port 21,22: M22x1.5 Plug Up Control Port 4: M16x1.5
Cross Ref.	1338135601050
Application	Foton Auman 6 Series Root Van (BJ1317vnpjj-19) Foton Auman Dump (BJ3258dlpjb-19)
RL3518TK01	
	Inlet Port 11: M16x1.5-6G Inlet Port 12: M18x1.5-6G Outlet Ports 21,22: M18x1.5-6G Control Port 4: M16x1.5-6G
Cross Ref.	13102356M0041
Application	Foton Rowor III -140

Repair Kits	Kits P/N	Repair Kits For	Cross Ref.	Application
	RL3518KM-9	RL3518KM	4730170002	Volvo 6226178
	RL3518AH-9 RL3518AK-9	RL3518AH RL3518AK	9730010002	DAF 080214 Iveco 02968774 MAN 81521166040 Mercedes 0005865742
	RL3518AZ-9	RL3518AZ	9730010062	DAF 1505410 Mercedes 003429134
	RL3518ZA-9	RL3518ZA		
	RL3518ZE-9	RL3518ZE		
	RL3518ZE-A-9	RL3518ZE-A		
	RL3518GB-9 RL3518GG-9 RL3518GH-9 RL3518GG-A-9	RL3518GB RL3518GG RL3518GH RL3518GG-A		American Trailer

Repair Kits	Kits P/N	Repair Kits For	Cross Ref.	Application
	RL3518HC-B-9 RL3518HG-A-9 RL3518JC-9	RL3518HC-B RL3518HG-A RL3518JC		
	RL3518JH-A-9 RL3518JH-B-9 RL3518JH-C-9 RL3518JB-A-9	RL3518JH-A RL3518JH-B RL3518JH-C RL3518JB-A		American Trailer
	RL3518LE-A-9 RL3518LE-B-9	RL3518LE-A RL3518LE-B		American Trailer
	RL3518EG-9	RL3518EG		American Trailer
	RL3518EA-9 RL3518ED-9	RL3518EA RL3518ED		American Trailer

Electronic Brake Control Units		5
ECU		5.01
Modulator Valve		5.02
Dual Modulator Valve		5.03
Solenoid Modulator		5.04
Speed Sensor		5.05
Bush		5.06
Grease		5.07
Cable		5.08
Pole wheel		5.09

		3550 120 005 0
		4S/3M. Working voltage: 24V
Application		Trailer

ECU	5.01
	3550 101 441 0 4S/4M. 100 Teeth Working voltage: 24V
Cross Ref.	446 004 307 0
Application	Truck, Bus, Tractor
	3550 106 661 0 6S/6M. 100 Teeth Working voltage: 24V
Application	Truck, Bus, Tractor
	3550 120 001 0 4S/2M. Working voltage: 24V
Application	Trailer
	3550 120 002 0 2S/2M. Working voltage: 24V
Application	Trailer

Modulator Valve	5.02
	RL3518SU01 Port 1: M26x1.5 Rest Port: 6xM16x1.5-6H Working voltage: 24V
Cross Ref.	4005000810 W/O4461080850
Application	DAF, KROGE, Trailer
	3550 517 001 0 2S/2M, 4S/2M & 4S/3M Port 1: M26 x 1.5 Other Ports: 6 x M16x1.5-6H Working Voltage: 24V
	3550 517 002 0 2S/2M, 4S/2M & 4S/3M Port 1: M26 x 1.5 Other Ports: 6 x M16x1.5-6H Working Voltage: 12V

Dual Modulator Relay	5.03
	RL3518ZZ Ports: 1+2=M22x1.5, 4=M16x1.5 Comment: 24 Volt Bayonet Solenoid
Cross Ref.	4721950410
Application	DAF 1624254 MAN N2524526001 RVI 5021170198 Krone 5815328
Repair Kit	RL3518ZZ-9

Dual Modulator Relay		5.03
RL3518ZZ-A		
	Ports: 1+2=M22x1.5 Port 4=M16x1.5 Comment: 12 Volt Bayonet Solenoid	
Cross Ref.	4721950440	

Solenoid Modulator		5.04
RL3550FA		
	Ports 1,2: M22x1.5,DC: 24V	
Cross Ref.	4721950180	
Application	DAF 1504901 Iveco 41027224 Scania 1376793 Volvo 1079666	
RL3550SM24		
	Ports 1,2: M22x1.5 Voss DC: 24V	
Cross Ref.	4721950160	
Application	DAF 1304635 MAN 4082200 Mercedes 0044296544 RVI 5010143058	

Modulator Relay		5.04
RL3518ZC		
	Ports: 1+2=M22x1.5, 4=M16x1.5	
Cross Ref.	4721950310	
Application	RVI 5021170197 Schmitz 050091 Krone 5815453 Kogel 349275	

		RL3518ZC-C
		Replaced By 472 195 031 0 Together With Cable 894 601 132 2
Cross Ref.	4721950200	
Alternative	4721950310	
Application	DAF 1325323 Evo-bus 7.788.061.000 Krone 58065270 Kogel 175308 Liebherr 5029 22901 Maz 8701,87011 87012,8926 9379,9758 97585,9919 Neoplan 07131.000 Schmitz 05009	

		RL3518ZC25
	Ports 1,2: 1/2-14 NPTF Port 4: 3/8-18 NPTF DC 12V	
Cross Ref.	4721950270	
Application	Truck	

		RL3518ZC01
	Inlet Port 1: φ15 Outlet Port 2: φ15 Control 4: φ10.2	
Cross Ref.	3518020-D828	
Application	FAW Sailong II Truck	

		RL3518ZM-A
	Ports: RES=M22x1.5, DEL=M16x1.5 Con=M16x1.5 Solenoid: M27x1.0 Voltage: 24V	
Cross Ref.	950364047	
Application	VAN Hool 10516941	

Speed Sensor		5.05
3550 301 808 0		
	Sensor 400mm length. Use set 3550 305 808 0(441 032 921 2) including 3550 301 808 0 , 3550 301 815 4 & 3550 990 200 0	
Cross Ref.	4410328080	
Application	Trailer	
	BPW	02.3317.05.00
	DAF	1315698
	Mercedes	0025423118
	Schmitz	050019
3550 301 809 0		
	Sensor 1000mm length. Use set 3550 305 809 0(441 032 922 2) including 3550 301 809 0, 3550 301 815 4 & 3550 990 200 0	
Cross Ref.	4410328090	
Application	DAF AMPA938	
	FAUN	9970 7730 190
	HMC	94600 7A150
	Krone	58078841
	Liebher	6923 08408
3550 301 861 0		
	Sensor 2500mm length. Use set 3550 305 861 0 including 3550 301 861 0 , 3550 301 815 4 & 3550 990 200 0	
Cross Ref.	4410328610	
3550 301 875 0		
	Sensor 1750mm length. Use set 3550 305 875 0 including 3550 301 875 0 , 3550 301 815 4 & 3550 990 200 0	
Cross Ref.	4410328750	
Application	General Truck/Trailer/HMC	
	RVI	5010422333

3550 301 814 0		
	Sensor 2020mm length. Use set 3550 305 814 0 including 3550 301 814 0 , 3550 301 815 4 & 3550 990 200 0	
Cross Ref.	4410328140	
Application	MAN	81271206117
3550 301 811 0		
	Sensor 1400mm length. Use set 3550 305 811 0 including 3550 301 811 0 , 3550 301 815 4 & 3550 990 200 0	
3550 330 808 0		
	Sensor 400mm length. Use set 3550 306 808 0 including 3550 330 808 0 , 3550 301 815 4 & 3550 990 200 0	
3550 330 809 0		
	Sensor 1000mm length. Use set 3550 306 809 0 including 3550 330 809 0 , 3550 301 815 4 & 3550 990 200 0	
3550 330 875 0		
	Sensor 1700mm length. Use set 3550 306 875 0 including 3550 330 875 0 , 3550301 815 4 & 3550 990 200 0	

Speed Sensor		5.05
3550 332 003 0		
	Sensor 350mm length. Use set 3550 307 003 0(441 032 905 0) including 3550 332 003 0 , 3550 301 815 4 & 3550 990 200 0	
Cross Ref.	4410329050	
Application	Trailer DAF 1506007 MAN	

	3550 306 808 0
	Length: 400mm
3550 306 809 0	
	Length: 1000mm
3550 306 875 0	
	Length: 1750mm

Sensor Set		5.05
3550 305 808 0		
		
Cross Ref.	4410329212	
Application	DAF 1506005 Iveco 5006041993 MAN N2255200061 RVI 5021170125 Scania 1784588	
3550 305 809 0		
Cross Ref.	4410329222	
Application	DAF 1506006 Iveco 5006041994 MAN N2255206003 RVI 5021170126 Scania 1738458	
3550 305 875 0		
	Length: 1750mm	
3550 305 814 0		
	Length: 2020mm	
Cross Ref.	4410329672	
3550 305 811 0		
	Length: 1400mm	

	3550 307 003 0
Cross Ref.	4410329632
Application	DAF 1506007 MAN N2255200062 Scania 1784590

Bush		5.06
3550 301 510 4		
	Stainless steel	
Cross Ref.	8997598154	
Application	Trailer 1315694 DAF 355034014 MAN	

Bush		5.06
		3550 301 815 4
	Copper plated	
Cross Ref.	8997605104	
Application	DAF	0669714
	Iveco	42061639
	Volvo	1196983

		3550 420 xxx 0
	Wire length: Adjustable Cable: 2x0.75mm ²	
Cross Ref.	449712xxx0	

Sensor Grease		5.07
		3550 990 200 0
	5g grease NUB 30 PTM	
Cross Ref.	8305020684	
Application	BPW	021040170

Modulator Conversion Plug		5.08
		3550 430 002 0
	Volt:24V	
Cross Ref.	8946011322	
Application	MAN	
	RVI	5021170262
	Scania	1774426

Modulator Cable		5.08
		3550 410 xxx 0
	Wire length: Adjustable Cable: 3x0.75mm ²	
Cross Ref.	449513xxx0	

Modulator Cable		5.08
		3550 411 xxx 0
	Wire length: Adjustable Cable: 3x0.75mm ² DIN72585	
Cross Ref.	449413xxx0	

Sensor Extension Cable		5.08
		3550 401 xxx 0
	Wire length: Adjustable Cable: 2x0.75mm ²	
Cross Ref.	449711xxx0	

Modulator Cable-Single		5.08
		3550 451 005 0
	Wire length: 400mm (length Adjustable)	
Cross Ref.	4494110050	
Application	DAF	1518041
	Krone	5815672

Modulator Cable-Dual		5.08
		3550 450 022 0 Wire length: 400mm.
Cross Ref.	4494440220	
Application	DAF	1518043
	Krone	5815329

Repair Kits	Kits P/N	Repair Kits For	Cross Ref.	Application
	RL3518ZZ-9	RL3518ZZ		

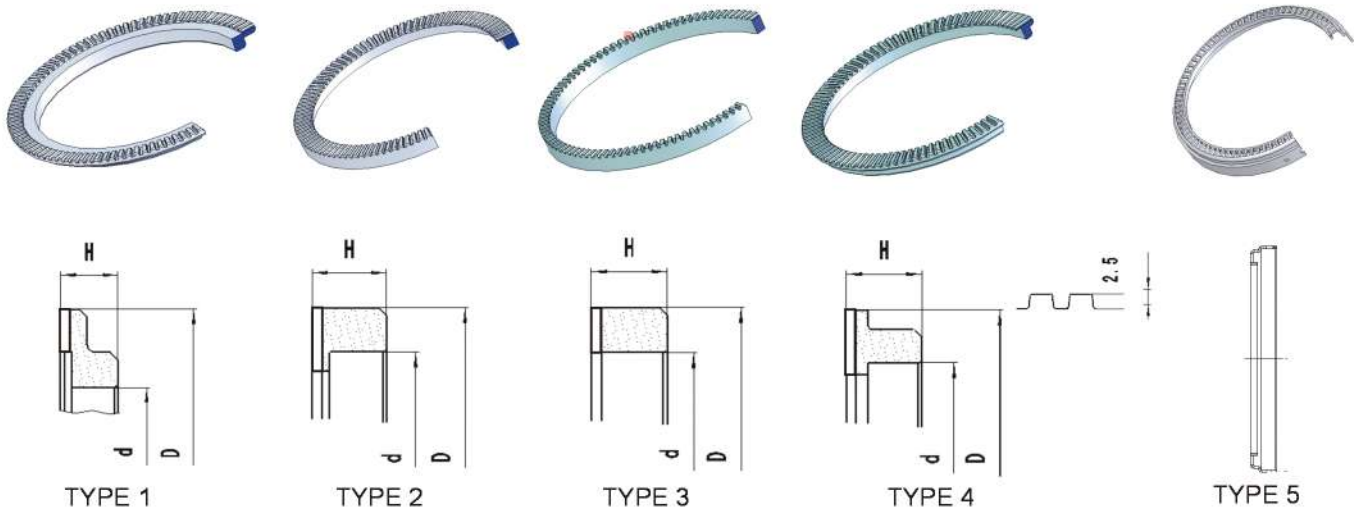







ABS Pole Wheel

SORL	Cross	Type	D	d	H	Teeth
3550 701 138 1		1	180	138	13	80
3550 701 152 1		3	170	152	15	100
3550 701 169 1	W3501152B06D1	1	211	169	11	100
3550 701 172 1	W3000010STRA-OK	1	196	172	15	100
3550 701 180 1		3	220	180	13	120
3550 701 184 1		3	204	184	15	100
3550 701 190 1	3550201B1H	3	210	190	12	100
3550 702 144 1	YM6900F3103008	3	177	144	12	80
3550 702 148 1	YM61233103104	1	175	148	13	100
3550 702 166 1	8847978114	1	207	166	15	100
3550 702 194 4	HJB16006-062\B.0	5	236	220	15.3	100
3550 703 153 1		3	169	153	15	100
3550 703 160 1		3	180	160	15	100
3550 703 165 1		3	190	165.5	12	100
3550 703 166 1	3550013-XY02A	1	207	166	9	100
3550 703 196 1		1	225	196.5	15	100
3550 710 108 1		3	138	108	10	80
3550 710 143 1	3550011KQP1	3	158	143	15	100
3550 710 150 1	3550011KB	1	192	150	15	100
3550 710 155 1	3550021KB	1	188	155	15	100



SORL	Cross	Type	D	d	H	Teeth
3550 710 165 1	H41-0401\13T	1	226	165	13	100
3550 710 166 1	JY3550N-012-Y	1	213	166	15	100
3550 710 170 1	H41-0101\16T	1	226	170	13	100
3550 710 172 1		3	196	172	15	100
3550 710 186 1		4	205	186	22	100
3550 710 188 1		1	230	188	12	100
3550 710 191 1		1	219	191	13	100
3550 710 285 1		1	305	193	48	100
3550 711 166 1	153	1	207	166	15	100
3550 751 138 1		1	172	138	15	80
3550 751 148 1	HFF3550011CKAK(ABS)	2	159	148	15	100
3550 751 151 1		2	160	151	13	100
3550 751 169 1	3550201-6S	2	182	169	15	100
3550 751 176 1		1	215	182	15	100
3550 751 186 1		4	205	186	22	100
3550 751 186 7	JY3550XM-014	4	205	186	22	100
3550 751 190 1		2	210	190	15	100
3550 751 194 1		2	206	194	18	100
3550 751 228 1		2	240	228	20	100

Air Suspension Control		6
Levelling Valve		6.01
Rotary Slide Valve		6.02
Raise/Lower Valve		6.03
Lift Axle Control Valve		6.04

Levelling Valve		6.01
		RL2908AA
	Ports: All M12x1.5 Comment: Round Lever	
Cross Ref.	4640060020	
Alternative	SV1307, 612017091	
Application	Scania 339792 MAN 4027060 Iveco IT4358 Krone 9450351 Kogel 312470 Schmikz 050419 82836370000	
Repair Kit	RL2908AA-9	
		RL2908AA07
	Ports 1,21,22: M12x1.5 Ports 12,23: M16x1.5	
Cross Ref.	4640061000	
Alternative	SV1410	
Application	DAF 1325336 MAN 1260680 Krone 5808613 Kogel 318955 Schmitz 50637 82854990000	
		RL2908AA10
	Port 1: M12x1.5 Port 21,22: M12x1.5 Port 12,23: M16x1.5	
Cross Ref.	4640061010	
Application	DAF 1518859 Scania 1738474	

		RL2908AA12
	All Ports thread: M12x1.5 Installation hole: ϕ 8.8	
		RL2908AA13
	All Ports: M12x1.5 Installation hole: ϕ 8.8 Without pendulum rod	
Cross Ref.	4640060110	
Application	Mercedes Scania	
		RL2908AA14
	Ports: M12x1.5 Installation hole: ϕ 8.8	
Cross Ref.	4640060120	
Application	Mercedes	
		RL2908AB
	Ports: All M12x1.5 Comment: Flat Lever	
Cross Ref.	4640060000	
Application	DAF 1506114 Volvo 1607728	
Repair Kit	RL2908AB-9	
		RL2908AD
	Ports: All M12x1.5	
Cross Ref.	4640060010	
Application	Iveco 04853325 RVI 5010260213	
Repair Kit	RL2908AD-9	



Levelling Valve		6.01
RL2908AE		
	Ports: 1,21,22 NPT1/4-18NPTF	
Cross Ref.	4640060030	
Application	Trailer	
RL2908AF		
	Ports: 1,21,22 NPT1/4-18NPTF	
Cross Ref.	4640060050	
Application	Trailer	
RL2908BA		
	Ports: All M12x1.5	
Cross Ref.	SV1294	
Alternative	4640025120, 4640025320	
Application	Trailer	
Repair Kit	RL2908BA-9	
RL2908BB		
	Ports: All M12x1.5 Comment: 160mm	
Cross Ref.	SV1310	
Application	Trailer	
Repair Kit	RL2908BB-9	





RL2908BB-A		
Ports: All M12x1.5 Comment: 120mm		
Cross Ref.	SV1361	
Application	Trailer	
RL2908CA		
	All Ports: M12x1.5	
Cross Ref.	SV1295	
Application	Scania	0426380
	Volvo	3038069
		8030222
	MAN	81436106061
Repair Kit	RL2908CA-9	
RL2908CB		
	Ports: All M12x1.5 Comment: 160mm	
Cross Ref.	SV1318	
Alternative	4640040000	
Application	DAF 1518856	
	Iveco 04675513	
	RVI 5021170185	
Repair Kit	RL2908CB-9	
RL2908DA		
	Ports 11, 21: M12x1.5 Ports 12, 23: M16x1.5	
Cross Ref.	SV1280	
Application	Trailer	
Repair Kit	RL2908DA-9	

Levelling Valve		6.01
RL2908DA05		
	Ports 11,21,22,4: M12x1.5 Ports 12,23: M16x1.5 Installation hole: ϕ 8.5	
Cross Ref.	SV1281	
Application	DAF Truck Mercedes Truck	
RL2908FA		
	Ports 1, 21, 22: M12x1.5	
Cross Ref.	4640023300	
Alternative	SV1211, 209001001	
Application	RVI	5000791021
	Volvo	1576736
	MAN	1065236
	Iveco	222685
	Krone	9451430, 945035
	Kogel	77415
	Schmikz	82836370000
Repair Kit	RL2908FA-9	
RL2908FG07		
	All Ports thread M12x1.5 Installation hole: ϕ 9.5	
RL2908XA01		
	Ports: 1, 21,22 M12x1.5 12,23 M16x1.5	
Cross Ref.	612032001	
Application	Trailer	
Repair Kit	RL2908XA-9	



RL2908GA		
	All Ports: M10x1	
Cross Ref.	4640070100	
Application	Scania	1399776
Repair Kit	RL2908GA-9	
RL2908GB		
	All Ports: M10x1 Comment: 0.5 bar Check In Delivery	
Cross Ref.	4640070020	
Application	Volvo	8141934
Repair Kit	RL2908GB-9	
RL2908GA19		
	Ports 1,2: ϕ 6 Installation Hole: 2x ϕ 8.5	
Cross Ref.	4640070300, 4640070010	
Application	DAF	0759050
	Iveco	05188642
	MAN	81436106129
RL2908GA07		
	Ports 1, 2: M10x1 Installation hole: ϕ 8.5	
Cross Ref.	4640070190	
Application	DAF	





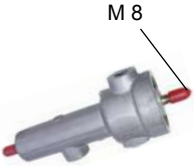

Levelling Valve		6.01	
		RL2908GA31	
		Ports 1, 2: $\phi 6$	
Alternative	4640070060		
Application	RVI	5010260390	7420745639
		RL2908GA32	
		Ports 1,2: $\phi 6$	
Alternative	4640070080		
Application	RVI	5010260060	7420745592
		RL2908GA33	
		Ports 1,2: $\phi 6$	
Alternative	4640070140		
Application	RVI	5010268932	7420746269
		RL2908GA34	
		Ports 1, 2: $\phi 6$	
Alternative	4640070070		
Application	RVI Volvo	5010260136	20746465

		RL2908GC	
		Ports: M10x1	
Cross Ref.	4640070110		
Application	Mercedes	A0003284530Z00	
Repair Kit	RL2908GC-9		
		RL2908EA	
		All Ports: NPT1/8	
Cross Ref.	90054007		
Application	American Trailer		
Repair Kit	RL2908EA-9		
		RL2908EB	
		All Ports: NPT1/8	
Cross Ref.	90054007		
Application	American Trailer		
		RL2908ED	
		Inlet Port: NPT1/8 Outlet Port: NPT1/8 Max Working Pressure: 1.2MPa	
		RL2908EF	
		Inletport: NPT1/8 Outlet Port: NPT1/8 Max Working Pressure: 1.2MPa Cover With Zinc Alloy	





Levelling Valve		6.01
RL2908EG		
	Inlet Port: NPT1/8 Outlet Port: NPT1/8 Max Working Pressure: 1.2MPa	
Application	Scania	1118884
RL2908JA		
	Ports 1, 2: NPT1/8	
Cross Ref.	20QE3126-P2	
Application	American Trailer	
Repair Kit	RL2908JA-9	
RL2908HA		
	All Ports: NPT1/4	
Cross Ref.	52341-Q135	
Application	American Trailer	
RL2908LA03		
	Inlet Port: NPT1/4 Outlet Port: NPT1/4 Max Working Pressure: 1.2MPa Mounting Thread: 1/4-20UNC Mounting Hole Centre: (38 ± 1)mm	
Cross Ref.	VS-227	
Application	American Truck	
RL2908LA06		
	Ports: NPT1/4 Installation size: 1/4-20UNC-2A	
Cross Ref.	MAK4000-57977000	
Application	Volvo, MACK	

RL2908PA01		
	All Port: NPT1/4	
Cross Ref.	KN27000	
Application	Truck Bus Trailer	
RL2908PA03		
	All Port: NPT1/4	
Cross Ref.	90555105	
Application	Truck, Bus, Trailer	
RL2908KA		
	Ports 1, 21, 22: NPT1/4	
Cross Ref.	90554241	
Application	Heavy Duty Truck	
Repair Kit	RL2908KA-9	
RL2908KB		
	Ports 1, 21, 22: M12x1.5	
Cross Ref.	90554243	
Application	Heavy Duty Truck	
Repair Kit	RL2908KB-9	
RL2908MA01		
	All Ports: M12x1.5	
Cross Ref.	0500005002000	
Application	Scania	279772
	Mercedes	A0003282130
Repair Kit	RL2908MA01-9	

Levelling Valve		6.01
RL2908MA02		
	All Ports: M12x1.5	
Cross Ref.	0500005001000	
Application	Scania	279771
	Mercedes	A0003282030
Repair Kit	RL2908MA02-9	
RL2908YA01		
	Ports: M12x1.5 Rod End: M 8	
Cross Ref.	AE 1122	
Application	Iveco, RVI	
Repair Kit	RL2908YA01-9	
RL2908YA02		
	Ports: M12x1.5 Rod End: M8	
Cross Ref.	AE1103	
Alternative	9640010020	
Application	Iveco	
	Schmitz	50049
Repair Kit	RL2908YA02-9	

Repair Kits	Kits P/N	Repair Kits For	Cross Ref.	Application
	RL2908AA-9 RL2908AB-9 RL2908AD-9	RL2908AA RL2908AB RL2908AD	4640060002	Volvo 276101
	RL2908BA-9 RL2908BB-9	RL2908BA RL2908BB	186534	Trailer
	RL2908CA-9 RL2908CB-9	RL2908CA RL2908CB	186534	Scania, Volvo
	RL2908DA-9	RL2908DA	174651	Trailer
	RL2908FA-9	RL2908FA	4640060002	Volvo 276101
	RL2908XA-9	RL2908XA		
	RL2908EA-9	RL2908EA		American Trailer

Repair Kits	Kits P/N	Repair Kits For	Cross Ref.	Application
	RL2908JA-9	RL2908JA		MACK
	RL2908KA-9 RL2908KB-9	RL2908KA RL2908KB		
	RL2908YA01-9	RL2908YA01	I69783	
	RL2908YA02-9	RL2908YA02	I69783	
	RL2908GA-9 RL2908GB-9 RL2908GC-9	RL2908GA RL2908GB RL2908GC		
	RL2908AA-8	RL2908AA		
	RL2908NA01-8	RL2908NA01 RL2908NA02 RL2908NA03	4410507182	Kogel, Schmitz
	RL2908FC-8	RL2908FA		



Rotary Slide Valve		6.02	
		RL8606CA	
	All Ports: M16x1.5		
Application	DAF	1291360	
Repair Kit	RL8606CA-9		
		RL8606BA	
	Port: 1=M16x1.5 All Others=M12x1.5		
Cross Ref.	4630320200		
Application	Volvo	6773736	
	Iveco	42089956	
	MAN	1065259	
	Krone	500945047	
		9450471	
	Kogel	77414	
	Schmitz	506, 80251720000	
Repair Kit	RL8606BA-9		
		RL8606GA	
	All Ports: M16x1.5		
Cross Ref.	SV3111		
Alternative	4630320000		
Application	DAF, Leyland	3300	
	Mercedes LK		
	Schmitz	050506	
		RL8606GB	
	Port: M16x1.5 Installation Bolt , Hole: M8, φ9		
Cross Ref.	SV3115		
Application	RV1	5000787082	

		RL8606FA01	
	All Ports: M12x1.5-6H		
Cross Ref.	AE1124		
Application	Truck, Busses		
	BPW	0243112600	





Solenoid Raise / Lower Valve		6.03	
		RL8606DA	
	Port 1: M16x1.5 Ports 11, 12, 13,21, 22: M12x1.5 Port 3: M22x1.5 Comment: 24 Volt Solenoid		
Cross Ref.	338050101		
Application	Volvo	3944186	
		8143448	
Repair Kit	RL8606DA-9		

Raise / Lower Valve		6.03	
		RL8606EA	
	Ports1, 3: M14x1.5 Other Ports: M12x1.5		
Cross Ref.	338021001		
Alternative	4630320200		
Application	EvoBus	8025172000	
	MAN	814361060014	
Repair Kit	RL8606EA-9		

Lift Axle Control Valve		6.04	
		RL3548KA	
	Ports: Port 20=M22x1.5 All Others M16x1.5 Comment: Switch Pressure Adjustable(2-7)bar		
Cross Ref.	4630840000		
Application	Scania	1738469	
	DAF	0867872	
	MAN	ZG046200002	

Lift Axle Control Valve		6.04	
		RL3548KB	
		Ports=M16x1.5, M22x1.5 Installation hole: ($\phi 9 \pm 0.5$) DC: 24V	
Cross Ref.	4630840110		
Application	DAF	1506107	
		RL8606HA	
		Ports 11,12,21,22: M16x1.5 DC: 24V	
Cross Ref.	4630840300		
Application	DAF	1518092	

		RL8606HB	
		All ports thread: M16x1.5 Installation hole: 3x $\phi 9$, DC: 24V	
Cross Ref.	4630840310		
Application	Krone	515003124	
	Kogel	361688	

Repair Kits	Kits P/N	Repair Kits For	Cross Ref.	Application
	RL8606CA-9	RL8606CA		MACK
	RL8606BA-9	RL8606BA	4630320012	
	RL8606DA-9	RL8606DA		
	RL8606EA-9	RL8606EA		

Electronic Air Suspension Control 7

Solenoid Valve For ECAS	7.01
Pressure Control Valve For ELC	7.02
Height Sensor For ECAS	7.03
Level Sensor	7.04
Pressure Sensor	7.05

Solenoid Valve For ECAS 7.01



RL3754EC01

All Ports: M22x1.5, DC: 24V
 Max Working Pressure: 20bar

Cross Ref.	4729000560	
Application	DAF	1193658
	Iveco	5006302001
	Volvo	20356554
	MAN	81259026168
	Mercedes	0003277425
Repair Kit	RL3754EC01-9	



RL3754EC02

All Ports: M22x1.5, DC: 24V
 Max Working Pressure: 20bar

Cross Ref.	4729000530	
Application	DAF	1302682
	Iveco	500310195
	MAN	81259026146
	Mercedes	0003276725
	Neoplan	11016529
Repair Kit	RL3754EC01-9	

RL3754EC03

All Ports: M22x1.5, DC: 24V
 Max Working Pressure: 20bar

Cross Ref.	4729000600	
Application	DAF	1506180
	Mercedes	0003276725
Repair Kit	RL3754EC01-9	

RL3754EC04

All Ports: M22x1.5, DC: 24V
 Max Working Pressure: 20bar

Cross Ref.	4729000620	
Application	DAF	1505294
	Scania	1383956
Repair Kit	RL3754EC01-9	

RL3754EC06

All Ports: M22x1.5, DC: 12V
 Max Working Pressure: 20bar

Cross Ref.	4729000730	
Repair Kit	RL3754EC01-9	

RL3754EC07



All Ports: M22x1.5, DC: 24V
 Max Working Pressure: 20bar



Cross Ref.	4729000550	
Application	DAF	1304587
	MAN	81259026145
	Krone	5813398
	Kogel	339077
	Schmitz	052540
Repair Kit	RL3754EC01-9	



RL3754EC09

All Ports: M22x1.5, DC: 24V
 Max Working Pressure: 20bar



Cross Ref.	4729000610	
Application	DAF	1506181
	Scania	1383955
Repair Kit	RL3754EC01-9	



Solenoid Valve For ECAS		7.01
RL3754EC12		
	All Ports: M22x1.5, DC: 24V Max Working Pressure: 20bar	
Cross Ref.	4729000630	
Application	DAF	1518917
	Iveco	41003307 41003307EB
Repair Kit	RL3754EC01-9	
RL3754EC10		
	Port 12: M16x1.5 Ports 14,22,23: M22x1.5 DC: 24V Max Working Pressure: 20bar	
Cross Ref.	4729000540	
Application	Krone	58137741
	MAN	81259026144
	RVI	5010143097
Repair Kit	RL3754EC01-9	
RL3754EC11		
	Ports 12,25: M16x1.5 Ports 14,21,22: M22x1.5 DC: 24V Max Working Pressure: 20bar	
Cross Ref.	4729000580	
Application	Mercedes	0003276625
	Kogel	339078
	Schmitz	052738
Repair Kit	RL3754EC01-9	
RL3754EC13		
	Port 12: M16x1.5 Ports 14,22,23: M22x1.5 DC: 24V Max Working Pressure: 20bar	
Cross Ref.	4729000740	
Application	RVI	5010422018
Repair Kit	RL3754EC01-9	

RL3754EC14		
	DC: 24V	
Cross Ref.	4729000660	
Repair Kit	RL3754EC01-9	
RL3754EC15		
	DC: 12V	
Cross Ref.	4729000760	
Repair Kit	RL3754EC01-9	
RL3754EC20		
	All Ports: M22x1.5, DC: 24V Max Working Pressure: 20bar	
Cross Ref.	4729000570	
Application	MAN	81259026158 81259029158
Repair Kit	RL3754EC01-9	
RL3754EC21		
	All Ports: NPT1/2, DC: 24V	
Cross Ref.	4729000670	
Repair Kit	RL3754EC01-9	
RL3754EC16		
	All Ports: M22x1.5, DC: 24V Max Working Pressure: 20bar	
Cross Ref.	4729001100	
Application	DAF	1506508
	Iveco	41003309
Repair Kit	RL3754EC01-9	

Solenoid Valve For ECAS		7.01
RL3754EC17		
	All Ports: M22x1.5, DC: 24V Max Working Pressure: 20bar	
Cross Ref.	4729001120	
Application	DAF	1518918
	Scania	1383958
Repair Kit	RL3754EC01-9	
RL3754EC18		
	All Ports: M22x1.5 DC: 24V Max Working Pressure: 20bar	
Cross Ref.	4729001130	
Application	DAF	1506182
	Scania	1383957
		1404397
Repair Kit	RL3754EC01-9	
RL3754EC19		
	All Ports: M22x1.5 DC: 24V Max Working Pressure: 20bar	
Cross Ref.	4729001140	
Application	DAF	1505296
	Iveco	41030745
Repair Kit	RL3754EC01-9	
RL3754EC100		
	All Ports: M22x1.5, DC: 24V	
Cross Ref.	4729000010	
Application	DAF	0527488
	Iveco	97106463
	MAN	81259026154
	Mercedes	0003276225
	Neoplan	102140300
Repair Kit	RL3754EC01-9	



RL3754EC101		
	All Ports: M22x1.5, DC: 24V Electrical Connections: 3xM27x1	
Cross Ref.	4729000020	
Application	DAF	1505290
	MAN	81259026117
Repair Kit	RL3754EC01-9	
RL3754EC103		
	Port 12: M16x1.5 All Other Ports: M22x1.5, DC: 24V Electrical Connections: 3xM27x1	
Cross Ref.	4729000060	
Application	MAN	81259026127
	Scania	1105670
Repair Kit	RL3754EC01-9	
RL3754EC106		
	All Ports: M22x1.5, DC: 24V	
Cross Ref.	4729000090	
Application	Scania	1338345
Repair Kit	RL3754EC01-9	
RL3754EC107		
	Port 12: M16x1.5 All Other Ports: M22x1.5, DC: 24V	
Cross Ref.	4729000120	
Application	DAF	1505292
	Scania	1381454
Repair Kit	RL3754EC01-9	

Solenoid Valve For ECAS		7.01
RL3754EC110		
	Port: M22x1.5, M16x1.5, DC: 24V	
Cross Ref.	4729000210	
Application	DAF	0527487
	Mercedes	0003276325
	Neoplan	102140210
	RVI	5010249007
	Krone	58104920
	Kogel	325209
Repair Kit	RL3754EC01-9	
RL3754EC111		
Port: M22x1.5, M16x1.5, DC: 24V		
Cross Ref.	4729000220	
Application	MAN	81259026113
	Neoplan	102140200
	RVI	5810112384
Repair Kit	RL3754EC01-9	
RL3754EC112		
	All Ports: M22x1.5, DC: 24V	
Cross Ref.	4729000300	
Application	DAF	0892110
	MAN	81259026155
	RVI	5010235153
Repair Kit	RL3754EC01-9	
RL3754EC113		
All Ports: M22x1.5, DC: 24V		
Cross Ref.	4729000320	
Application	MAN	81259026132
Repair Kit	RL3754EC01-9	

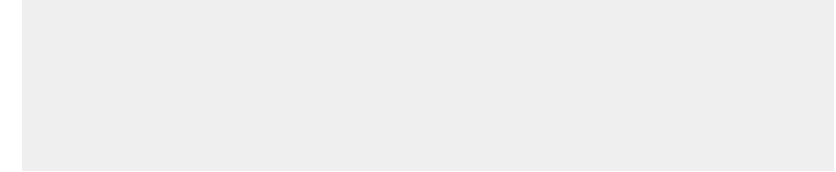
RL3754EC117		
	All Ports: M22x1.5, DC: 24V Electrical Connections: 5xM27x1	
Cross Ref.	4729000590	
Application	Iveco	5010207352
	RVI	5010207352
Repair Kit	RL3754EC01-9	
RL3754EC119		
All Ports: M22x1.5, DC: 24V		
Cross Ref.	4729000510	
Application	RVI	5010197213
Repair Kit	RL3754EC01-9	
RL3754EC120		
All Ports: M22x1.5, DC: 24V Electrical Connections: 6xM27x1		
Cross Ref.	4729000500	
Application	DAF	1518108
	Iveco	98490676
	MAN	81259026118
	Neoplan	102140400
Repair Kit	RL3754EC01-9	
RL3754EC118		
	All Ports: M22x1.5, DC: 24V	
Cross Ref.	4729000520	
Application	Scania	1372186
Repair Kit	RL3754EC01-9	





Solenoid Valve For ECAS		7.01
RL3754EC115		
	All Ports:: M22x1.5, DC: 24V	
Cross Ref.	4729001010	
Application	DAF	0527486
	MAN	1170479
	RVI	5010135712
Repair Kit	RL3754EC01-9	
RL3754EC116		
	All Ports: M22x1.5, DC: 24V	
Cross Ref.	4729001020	
Application	DAF	0537003
	MAN	81259026112
	Scania	1365414
Repair Kit	RL3754EC01-9	
RL3754EC-A		
	All Ports: M22x1.5 Installation bolt: 2xM8 Working voltage: 24V.With two silences	
Cross Ref.	4729051180	
Application	Scania	1453164
Repair Kit	RL3754EC-A-9	
RL3754EB-B		
	All Ports: M22x1.5 Installation bolt: 2xM8 Working voltage: 24V.With two silences	
Cross Ref.	4729051140	
Application	DAF	1518110
	Schmitz	052703
Repair Kit	RL3754EC-A-9	

RL3754EC-B		
	All Ports: M22x1.5 Installation bolt: 2xM8 Working voltage: 24V.With one silence	
Cross Ref.	4729051110	
Application	DAF	1305452
	MAN	81259026147
	Mercedes	0003276825
	Kogel	337816
Repair Kit	RL3754EC-A-9	
RL3754EC-C		
	All Ports: M22x1.5 Installation bolt: 2xM8 Working voltage: 24V.With one silence	
Cross Ref.	4729051160	
Application	DAF	1523999
	RVI	5010143098
Repair Kit	RL3754EC-A-9	
RL3754EC301		
	All Ports: M22x1.5 DC: 24V Working pressure: 5-13bar	
Cross Ref.	4728800640	
Application	DAF	1150130, 1525422
	Mercedes	0003279725

Pressure Control Valve For ELC		7.02
RL3754EL01		
	DC: 24V Ports 1,21,22: M16x1.5 Installation Holes: 2xΦ10	
Cross Ref.	0501100031000	
Application	Volvo	3944716
Repair Kit	RL3754EL-9	

Pressure Control Valve For ELC 7.02	
RL3754EL02	
	DC: 24V Ports 1,21,22: M16x1.5
Cross Ref.	0501100041000
Alternative	0501100035000
Application	Alero Bus
RL3754EL04	
	All ports thread: M16x1.5 Working pressure: (5-13)bar, DC 24V
Cross Ref.	0501100052000
Application	Volvo 3944719 20392040
Repair Kit	RL3754EL-9
RL3754EL05	
	DC: 24V Ports 1,21,22,23: M16x1.5
Cross Ref.	0501100029000
Application	Volvo B7R, B10M, 3944717
RL3754EL06	
	DC: 24V Ports 1,21,22,23: M16x1.5

Height Sensor For ECAS 7.03	
RL2908NA01	
	Socket: $\Phi 23.5 \pm 0.1$ Rod: MAX100°
Cross Ref.	4410500110
Application	DAF 1305844 Iveco 98472878 MAN 81259370016 Mercedes 0005424018 Neoplan 11016524 RVI 5010143095 Scania 1379941 Krone 505813397 5813397 Kogel 337323 Schmikz 052539
RL2908NA02	
	Socket: $\Phi 23.5 \pm 0.1$ Rod: MAX100° DC: (8-16)V
Cross Ref.	4410500120
Alternative	4410500130
Application	DAF 1505054 Iveco 500340806 Kogel 69093 MAN 81259370023 Mercedes 0005424018 Krone 5815978
RL2908NA03	
	Socket: M24x1, DC: (5-15)V
Cross Ref.	4410500080
Application	DAF 1247631 MAN 81259370010 Mercedes 0105427817

Height Sensor For ECAS		7.03
		RLD5-M041
Cross Ref.	4410501230	
Alternative	4410501200 4410501210 4410501220	
Application	MAN	81259370040
		RLD5-M042
Cross Ref.	4410501000	
Application	DAF	1365935
	RVI	5010422344

Pressure Sensor		7.05
		RLD5-M046
		Port thread: M16x1.5, DC: (8-32)V
Cross Ref.	4410400150	
Alternative	4410441020	
Application	DAF	1450872
	Iveco	41200718
		RLD5-M047
		Port thread: M16x1.5, DC (8-32)V
Cross Ref.	4410441080	
Alternative	4410440010	
Application	Universal	

Level Sensor		7.04
		RL2908MB
		Installation hole: 2x Φ 8 Installation hole spacing: (50 \pm 0.2)mm Connector pin 3x Φ 2.5, R=5K Ω +20%
Cross Ref.	K013741N00	
Application	Volvo	20850557A
		RL2908MC
		Installation hole: 2x Φ 8 Installation hole spacing: (50 \pm 0.2)mm Connector pin 3x Φ 2.5, R=5K Ω +20%
Cross Ref.	050400211400	
Application	MAN	

Repair Kits	Kits P/N	Repair Kits For	Cross Ref.	Application
	RL3754EC01-9	3754 042 Series		
	RL3754EC-A-9	3754 044 Series		
	RL3754EL-9			
	3754 045 002 8	RL3754EL02 RL3754EL04 RL3754EL05 RL3754EL06		
	3754 045 006 8			
	RL3754EL01-9			
	3754 045 001 8	RL3754EL01		
	3754 045 003 8			





Drive Line		8
Clutch Servo		8.01
Pipe Connector		8.02
Clutch Master Cylinder		8.03
Shift Knob		8.04

Clutch Servo		8.01
RL1608VA01		
	Dia: 80mm Stroke: 40mm Air: M12x1.5 Hyd: 7/16-20UNF Push Rod: M12x1.5	
Application	Volvo	
RL1608VA03		
	Dia: 80mm Stroke: 40mm Air(11): M12x1.5 Hyd(1-4): UNF7/16-20 Push Rod: M12x1.25	
Cross Ref.	626392AM	
Application	Volvo F10, FL7, F12 1526523	
RL1608VA04		
	Dia: 80mm Stroke: 40mm Air(11): M16x1.5 Hyd(1-4): UNF7/16-20 Push Rod: M12x1.5	
Application	Volvo	
RL1608VA05		
	Dia: 95mm Stroke: 70mm Air(11): M16x1.5 Hyd(1-4): M14x1.5 Push Rod: M12x1.25	
Cross Ref.	626639AM	
Application	Volvo 1671953, 1521371 1668501, 1655435	

RL1608XA		
	Dia: 80mm Stroke: 80mm Air(11): M16x1.5 Hyd: M14x1.5	
Cross Ref.	622785AM	
Application	MAN, DAF, Scania, Volvo	
Repair Kit	RL1608XA-9	
RL1608XB		
	Dia: 100mm Stroke: 85mm Air(11): M16x1.5 Hyd: M14x1.5	
Application	DAF, FAW	
Repair Kit	RL1608XB-9	
RL1608XC		
	Dia: 100mm Stroke: 70mm Air(11): M16x1.5 Hyd: M14x1.5	
Cross Ref.	622190AM	
Application	Scania 371612 374116 5751843	
Repair Kit	RL1608XC-9	
RL1608XC01		
	Dia: 100mm, Stroke: 85mm Air: M16x1.5, Hyd: M14x1.5	
Cross Ref.	622508AM	
Alternative	626400AM, 625291AM	
Application	DAF 1241257, 1327940 1346863, 1443531	



Clutch Servo		8.01
RL1608XC02		
	Dia: 100mm, Stroke: 80mm Air: M16x1.5, Hyd: M12x1.5	
Cross Ref.	627805AM, 628494AM	
Alternative	627303AM	
Application	Volvo	8171722 3192977
RL1608XC03		
	Dia: 100mm Stroke: 80mm Air: M16x1.5 Hyd: M14x1.5	
Cross Ref.	KA625559	
Application	ISUZU	1-31800-404-0
RL1608XC05		
	Dia: 100mm Stroke: 80mm Port 11: M16x1.5, 14: M12x1.5 Installation hole: 4xΦ9 Push rod length: 178mm	
Application	Volvo	
RL1608XC06		
	Dia: 100mm Strok: 80mm Port 11: M16x1.5, 14: M12x1.5 Installation hole: 4xΦ9 Push rod length: 155mm	



RL1608XC07		
	Dia: 100mm Stroke: 80mm Port 11: M16x1.5, 14: M14x1.5 Installation Hole: 4xΦ9 Push rod Length: 110mm	
Application	DAF	
RL1608XD		
	Dia: 100mm, Stroke: 70mm Air(11): M16x1.5, Hyd: M14x1.5	
Cross Ref.	622199AM	
Application	Scania	1331770 1747895 575180
RL1604AA01		
	Dia: 100mm Stroke: 27.5mm Hyd: M14x1.5	
Application	Scania	
RL1604AA03		
	Air Inlet: M16x1.5 Out-oil Port: M14x1.5 Stroke Max 27.5mm	
Cross Ref.	629683AM	
Application	Scania	1367453 1421186 1513717

Clutch Servo		8.01	
	RL1608ZA01	Stroke: 23mm Energy Supply: M14x1.5 Oil Inlet: M14x1.5	
Cross Ref.	1642176708		
Application	RVI	5000050272 5000130533	
	RL1608AM01	Dia: 70mm Air: M14x1.5 Hyd: M12x1 Comment: Without Push-rod Fork	
	RL1608AM02	Dia: 70mm Air: M14x1.5 Hyd: M12x1.5	
Cross Ref.	642-03179		
Application	ISUZU		
	RL1608AM04	Dia: 70mm Stroke: 35mm Port 11: M14x1.5, 14: M12x1.5 Installation hole: 4xM8 Comment: Same as RL1608AM difference is without letter and not ball blast	
Cross Ref.	642-03080		
Application	HINO, Nissan, Mitsubishi		
	RL1608AN	Dia: 70mm Air(11): M14x1.5 Hyd: M12x1.5 Comment: Without Push-rod Fork	

	RL1608AN01	Dia: 70mm Air: M14x1.5 Hyd: M12x1.5	
Cross Ref.	642-09004		
Application	ISUZU		
	RL1608AN02	Dia: 70mm Air: M14x1.5 Hyd: M12x1.5 Comment: With Push-rod Fork	
Application	Nissan, HINO		
	RL1608BL	Dia: 90mm Air: M14x1.5, 17/32" -24UN-2A Hyd: M12x1.5 Comment: Without Push-rod Fork	
Application	Nissan		
	RL1608BM01	Dia: 90mm Air: M14x1.5 Hyd: M12x1.5 Comment: With Push-rod Fork	
Application	Nissan		





Clutch Servo		8.01
RL1608BM02		
	Dia: 90mm Air: M14x1.5 Hyd: M12x1 Comment: Without Push-rod Fork	
Application	Nissan	
RL1608BM03		
	Dia: 90mm Stroke: 35mm Air(11): M14x1.5 Hyd(1-4): M12x1.25	
Cross Ref.	SK6115-1605900B1	
Application	XiaMen Kinglong	
RL1608BM05		
	Dia: 90mm Stroke: 35mm Port 11: M14x1.5, 14: M12x1.5 Installation hole: 4xM10 Comment: Same as RL1608BM difference is without letter and not ball blast	
Cross Ref.	642-03502	
Application	Nissan, HINO, Mitsubishi	
RL1608AM		
	Dia: 70mm Air: M14x1.5 Hyd: M12x1.5 Comment: Without Push-rod Fork	
Cross Ref.	642-03080	
Application	Nissan, HINO, Mitsubishi	
Repair Kit	RL1608AM-9	



RL1608BM		
Dia: 90mm Air: M14x1.5 Hyd: M12x1.5 Comment: Without Push-rod Fork		
Cross Ref.	642-03502	
Application	Nissan, HINO	
RL1608BM-A		
Dia: 90mm Air: M14X1.5 Hyd: M12X1.5 Comment: Without Push-rod Fork		
RL1609BY02		
	Dia: 90mm Air: M14X1.5 Hyd: M12X1.5	
Cross Ref.	642-09102	
Application	ISUZU, HINO	
RL1609BY03		
	Dia: 90mm Air: M14X1.5 Hyd: M12X1.5 Comment: With Push-rod Fork	
Application	Nissan	
RL1609BH		
	Dia: 90mm Air: M14X1.5 Hyd: M12X1 Comment: Without Push-rod Fork	
Application	TATA	264129200112
Repair Kit	RL1609BH-9	

Clutch Servo		8.01
RL1608DA		
	Dia: 105mm Air: M16x1.5 Hyd: M12x1.5 Comment: Without Push-rod Fork	
Cross Ref.	642-03505	
Application	King Long	
Repair Kit	RL1608DA-9	
RL1608DA-K		
	Dia: 105mm Air: M16x1.5 Hyd: M12x1.5 Comment: Without Push-rod Fork	
RL1608DA01		
	Dia: 105mm Air: M14x1.5 Hyd: M12x1.5 Stroke: 35mm Comment: Without Push-rod Fork	
RL1608DA02		
	Dia: 105mm Air: M14X1.5 Hyd: M12X1.5	
Cross Ref.	642-09408	
Application	HINO	32210-1601 32210-1600
RL1608DA03		
	Dia: 105mm Stroke: 35mm Air(11): M14X1.5 Hyd(1-4): M14X1.5	
Cross Ref.	216500130	
Application	XiaMen Kinglong	

RL1608DB		
	Dia: 105mm Air: M14x1.5, 17/32"-24UN-2A Hyd: M12x1.5	
Cross Ref.	63.5713.00	
Application	Nissan	41700-7D000
RL1608KA		
	Stroke: 72mm Air: M16x1.5 Hyd: M14x1.5	
Cross Ref.	9700511310	
Application	DAF	1518247
	Mercedes	0012953107
Repair Kit	RL1608KA-9	
RL1608LB		
	Dia: 102mm Stroke: 70mm Air: M16x1.5 Hyd: M14x1.5	
Cross Ref.	9700511580	
Application	DAF	1506456
	Mercedes	0002951518
Repair Kit	RL1608LB-9	
RL1608LB-A		
	Dia: 102mm Stroke: 70mm Air: M16x1.5 Hyd: M14x1.5	
Cross Ref.	9700511590	
Application	DAF	1505140
	Mercedes	0002951418
Repair Kit	RL1608LB-A-9	

Clutch Servo		8.01
RL1608LA		
	Dia: 102mm Stroke: 76.8mm Air: M16x1.5 Hyd: M14x1.5 Comment: Control Port For Samt	
Cross Ref.	VG3361	
Application	Mercedes	0002950918
Repair Kit	RL1608LA-9	
RL1608EA02		
	Dia: 76.5mm Stroke: 85mm Air(11): M16x1.5 Hyd(1-4): M14x1.5	
Cross Ref.	9700514350	
Application	ZF	0501007075
	Yutong	1604-00204
	King Long	16202-04010
RL1608EA03		
	Dia: 76.5mm Stroke: 85mm Air: M16x1.5 Hyd: M14x1.5	
Application	DAF, MAN	
RL1608EA04		
	Dia: 76.5mm Stroke: 80mm Air(11): M16x1.5 Hyd(1-4): M14x1.5	
RL1608EA05		
	Dia: 76.5mm Stroke: 85mm Air: M16x1.5 Hyd: M14x1.5	
Application	DAF, MAN	

RL1608EA15		
	Dia: 102mm Stroke: 85mm Air(11): M22x1.5 Hyd(14): M14x1.5 Comment: Use Mineral Oil	
Cross Ref.	9700514120	
Application	DAF	1506465
	MAN	81307256084
Repair Kit	RL1608EA15-9	
RL1608EA08		
	Dia: 102mm Stroke: 75mm Air(11): M16x1.5 Hyd(1-4): M14x1.5	
Cross Ref.	9700514220	
Application	Iveco	5010452512
	RVI	5010452512
RL1608EA09		
	Dia: 102mm Stroke: 85mm Air(11): M16x1.5 Hyd(1-4): M14x1.5	
Cross Ref.	9700514240	
Application	DAF	1506467
	Iveco	5010556022
	MAN	N2307160011
RL1608EA		
	Dia: 102mm Stroke: 85mm Air: M16x1.5 Hyd: M14x1.5	
Cross Ref.	9700514070	
Application	ZF	0501005852
Repair Kit	RL1608EA-9	

Clutch Servo		8.01	
RL1608EE			
	Dia: 102mm Stroke: 85mm Air: M16x1.5 Hyd: M14x1.5		
Cross Ref.	9700514230		
Application	DAF	1506466	
	RVI	501006570	
	ZF	0501006570	
	Scania	1935601	
Repair Kit	RL1608EE-9		
RL1608EF			
	Dia: 102mm Stroke: 85mm Air: M16x1.5 Hyd: M14x1.5		
Cross Ref.	9700514130		
Application	MAN, DAF, RVI		
Repair Kit	RL1608EF-9		
RL1608EB04			
	Dia: 102mm Stroke: 80mm Air(11): M16x1.5 Hyd(1-4): Φ 12		
Application	Mercedes		
Repair Kit	RL1608EB04-9		
RL1608EC14			
	Dia: 102mm Stroke: 85mm Air(11): M16x1.5 Hyd(1-4): Φ 12 Comment: Use Mineral Oil		
Cross Ref.	9700514410		
Application	MAN	81307256104	
	Mercedes	0002540447	

RL1608EC01			
	Dia: 102mm Stroke: 85mm Air: M16x1.5 Hyd: M14x1.5		
Cross Ref.	9700514310		
Application	Mercedes	A0002952818	
RL1608EC13			
	Dia: 102mm Stroke: 85mm Air: M16x1.5 Hyd: M14x1.5		
Cross Ref.	9700514050		
Application	Mercedes	A0002540047Z00	
Repair Kit	RL1608EC-9		
RL1608EC09			
	Port 11: M16x1.5 Port 4: M14x1.5, Φ 12, DC (8-16)V		
Cross Ref.	9700514330		
Application	Mercedes	0002953718	

Distance Sensor Module		8.01	
RL1608EC04-8			
			
Cross Ref.	4411005312		
Application	Volvo	1521492	

Clutch Servo		8.01	
RL1608EH			
	Dia: 102mm Stroke: 85mm Air: M22x1.5 Hyd: M14x1.5		
Cross Ref.	9700514140		
Alternative	II31733		
Application	MAN	81307256065	
RL1608EH31			
	Port 11: M22x1.5-6H Port 14: M14x1.5-6H Push rod: M12x1.25-6H		
Cross Ref.	9700514570		
Application	RVI		
RL1608HA01			
	Dia: 102mm Stroke: 74mm Air(11): M16x1.5 Hyd(1-4): M14x1.5 Air Inlet(12): M12x1.5 Delivery(22): M12x1.5		
Cross Ref.	9700514550		
Application	Iveco	504177095	
RL1608HA10			
	Port 11: M22x1.5 Port 14: M14x1.5 Ports 12, 22: M12x1.5		
Cross Ref.	9700514380		
Application	DAF	1519286	
	Iveco	0504103066	
	RVI	5010452511	

RL1608PA01			
	Dia: 102mm Stroke: 85mm Air(11): M16x1.5 Hyd(14): M14x1.5		
Cross Ref.	9700511640		
Application	Mercedes	0002951318	
RL1608PS			
	Dia: 85mm Stroke: 65mm Air(11): M16x1.5 Hyd: M14x1.5		
Cross Ref.	9700511510		
Application	DAF	1518250	
	Mercedes	0002950818	
Repair Kit	RL1608PS-9		
RL1608PA06			
	Dia: 102mm Stroke: 85mm Air(11): M16x1.5 Hyd(14): M14x1.5		
Cross Ref.	9700511570		
Alternative	VG 3229, II14194		
Application	DAF	1518251	
	MAN	81307256053	
RL1608PU			
	Dia: 102mm Stroke: 85mm Air(11): M16x1.5 Hyd: M14x1.5		
Cross Ref.	9700511720		
Application	ZF	0501005138	

Clutch Servo		8.01	
RL1608PC-A			
	Air: M16x1.5 Hyd: M14x1.5		
Cross Ref.	9700511000		
Application	MAN, DAF ZF	0501008846	
RL1608PA08			
	Dia: 102mm Stroke: 85mm Air(11): M16x1.5 Hyd(14): M14x1.5		
Cross Ref.	9700511250		
Application	VW	2W0721257A	
RL1608PA			
	Dia: 76.5mm Stroke: 67mm Air(11): M16x1.5 Hyd: M14x1.5		
Repair Kit	RL1608PA-9		
RL1608PC			
	Dia: 76.5mm Stroke: 67mm Air(11): M16x1.5 Hyd: M14x1.5		
Cross Ref.	9700511140		
Application	Iveco	1261885	
	DAF	0659807	
	ZF	0501202572	
Repair Kit	RL1608PC-9		



		RL1608PQ	
	Dia: 76.5mm Stroke: 67mm Air(11): M16x1.5 Hyd: M14x1.5		
Cross Ref.	9700511260		
Application	DAF	1518245	
	Iveco	42037229,42037766	
	Neoplan	042320200	
	RVI	5000815689	
		5000815699	
Repair Kit	RL1608PQ-9		
		RL1608PR	
	Dia: 76.5mm Stroke: 67mm Air(11): M16x1.5 Hyd: M14x1.5		
Cross Ref.	9700511020		
Alternative	VG3204		
Application	DAF	0658882	
	Iveco	04776623	
	Mercedes	6992950018	
RL1608PA03			
	Dia: 76.5mm Stroke: 85mm Air: M16x1.5 Hyd: M14x1.5		
Cross Ref.	9700511110		
Application	MAN	81307256014	
RL1608PA04			
	Dia: 76.5mm Stroke: 85mm Air: M16x1.5 Hyd: M14x1.5		
Cross Ref.	9700511360		
Application	DAF	0390486	

Clutch Servo		8.01	
RL1608PB			
	Dia: 76.5mm Stroke: 85mm Air: M16x1.5 Hyd: M14x1.5		
Cross Ref.	9700511560		
Application	ZF	0501005065	
RL1608PK			
	Dia: 76.5mm Stroke: 85mm Air(11): M16x1.5 Hyd: M14x1.5		
Cross Ref.	9700511370		
Application	DAF	1518249	
	Mercedes	0002950018	
Repair Kit	RL1608PK-9		
RL1608PT			
	Dia: 76.5mm Stroke: 85mm Air(11): M16x1.5 Hyd: M14x1.5		
Cross Ref.	9700511830		
Application	DAF	1506460	
	ZF	0501006545	
Repair Kit	RL1608PT-9		
RL1608PA02			
	Dia: 102mm Stroke: 85mm Air(11): M16x1.5 Hyd: M14x1.5		
Cross Ref.	9700511740		
Application	DAF	1506458	
	Mercedes	0002952318	

RL1608PG			
	Dia: 102mm Stroke: 85mm Air(11): M16x1.5 Hyd: M14x1.5		
Cross Ref.	9700511700		
Application	MAN	81307256062	
Repair Kit	RL1608PG-9		
RL1608PH			
	Dia: 102mm Stroke: 85mm Air(11): M16x1.5 Hyd: M14x1.5		
Cross Ref.	9700511520		
Application	Neoplan	042320800	
	Mercedes	0002952318	
Repair Kit	RL1608PH-9		
RL1608PJ			
	Dia: 102mm Stroke: 85mm Air(11): M16x1.5 Hyd: M14x1.5		
Cross Ref.	9700511650		
Application	Neoplan	042321100	
	ZF	0501004575	
Repair Kit	RL1608PJ-9		
RL1608PA05			
	Dia: 102mm Stroke: 85mm Air(11): M16x1.5 Hyd: M14x1.5		
Cross Ref.	9700511760		
Application	DAF	1506459	
	MAN	N1011010080	
	Neoplan	11010080	

Clutch Servo		8.01	
RL1608PS01			
Dia: 85mm Stroke: 65mm Air(11): M16x1.5 Hyd: M14x1.5			
Cross Ref.	9700511900		
Application	Mercedes	0002540147	
RL1608PE			
Dia: 102mm Stroke: 58mm Air(11): M16x1.5 Hyd: M14x1.5			
Cross Ref.	9700511240		
Application	DAF	1518244	
	Iveco	5000787875	
	RVI	5000787875	
Repair Kit	RL1608PE-9		
RL1608PL			
Dia: 102mm Stroke: 58mm Air(11): M16x1.5 Hyd: M14x1.5			
Cross Ref.	9700511070		
Application	Scania	343362,345362	
Repair Kit	RL1608PL-9		
RL1608PF			
	Dia: 102mm, Air: M16x1.5 Ports 12,22: M12x1.5 Hyd: M14x1.5		
Cross Ref.	9700512090		
Application	DAF	1518254	
	RVI	5000673126	
Repair Kit	RL1608PF-9		









RL1608PF01			
	Dia: 76.5mm, Air: M16x1.5 Ports 12,22: M12x1.5 Hyd: M14x1.5		
Cross Ref.	9700512260		
Application	Volvo	20812661	
RL1608PE02			
	Dia: 102mm Stroke: 58mm Air(11): M16x1.5 Hyd: M14x1.5		
Cross Ref.	9700511280		
Application	DAF	1518246	
	Mercedes	0012955607	
RL1608PE01			
Dia: 102mm Stroke: 58mm Air(11): M16x1.5 Hyd: M14x1.5			
Cross Ref.	9700511790		
Application	Mercedes	3842957018	
RL1608PA07			
Dia: 102mm Stroke: 85mm Air(11): M16x1.5 Hyd: M14x1.5			
Cross Ref.	9700511840		
Application	Mercedes	0002953618	





Clutch Servo		8.01
RL1608CA		
	Dia: 75mm, Stroke: 84mm Air: M16x1.5, Hyd: M14x1.5	
Cross Ref.	VG3200	
Alternative	9700511110	
Application	MAN	F80, F81
	Iveco	
Repair Kit	RL1608CA-9	
RL1608CK		
	Dia: 102mm Air: M14X1.5 Hyd: M14X1.5	
Application	North Benz	5062950407
RL1608FA		
	Dia: 90mm, Stroke: 50mm Air: M16x1.5, Hyd: M14x1.5	
Application	Dongfeng Truck	1608Z60-001
Repair Kit	RL1608FA-9	
RL1608GK		
	Dia: 75mm Air: M16x1.5 Hyd: M12x1.25 Comment: With Push-rod Fork	
Application	Foton Rowor	13072162X0034



RL1608GK01		
	Dia: 75mm Stroke: 35mm Inlet Port 1: M10x1 Oil Inlet Port 2: M12x1.25	
Application	Foton Rowor	13042162M0111
RL1608GK02		
	Dia: 75mm Air: M14x1.5 Hyd: M12x1	
RL1608GK03		
	Dia: 75mm Air: M14x1.5 Hyd: M12x1	
RL1608NZ58		
	Dia: 90mm Stroke: 70mm Air(11): M16x1.5, NPT1/4 Hyd(1-4): M14x1.5	
Cross Ref.	WG9719230029	
Application	CNHTC Howo	
RL1608WE03		
	Dia: 102mm Stroke: 70mm Air(11): M16x1.5 Hyd(1-4): M14x1.5	
Cross Ref.	16SPD-04010	
Application	SuZhou King Long	

Clutch Servo		8.01
RL1608WE04		
	Dia: 102mm Stroke: 70mm Air(11): M16x1.5 Hyd(1-4): M14x1.5	
Cross Ref. Application	WG9114230018 CNHTC Howo	
RL1608UA-A		
	Port 11: M16x1.5, 14: M12x1.5 Installation hole: 4xφ9 Push rod length: 100 ± 2mm	
Cross Ref. Application	41710-Y1010.2 JAC HCV GALLOP/TIPPER	

Repair Kits	Kits P/N	Repair Kits For	Cross Ref.	Application
	RL1608XA-9	RL1608XA	625218AM	DAF 1291857 1443525 Leyland 1291857
	RL1608XB-9	RL1608XB		
	RL1608XC-9	RL1608XC		Scania
	RL1608AM-9	RL1608AM		
	RL1609BH-9	RL1609BH		TATA 264129200114
	RL1608DA-9	RL1608DA		
	RL1608KA-9	RL1608KA	9700519032	Mercedes 0002903267 DAF
	RL1608LB-9 RL1608LB-A-9	RL1608LB RL1608LB-A	9700519162	DAF 1519290 Mercedes 0002900347

Repair Kits	Kits P/N	Repair Kits For	Cross Ref.	Application
	RL1608LA-9	RL1608LA	14195008	Mercedes
	RL1608EA-9 RL1608EE-9 RL1608EF-9	RL1608EA RL1608EE RL1608EF	9700519432	MAN 81307256079
	RL1608EB09-9	RL1608PA01	9700519452	
	RL1608EB05-9	RL1608EB05	WSK.28.19C	
	RL1608EC06-9	RL1608EC06	WSK..19	
	RL1608EC07-9	RL1608EB04		
	RL1608EB14-9	RL1608PA05	9700519502	
	RL1608EC-9	RL1608EC	9700519492	

Repair Kits	Kits P/N	Repair Kits For	Cross Ref.	Application
	RL1608PS-9	RL1608PS		
	RL1608PA-9 RL1608PC-9 RL1608PQ-9 RL1608PR-9	RL1608PA RL1608PC RL1608PQ RL1608PR	9700519042	MAN 9700519042 DAF 0698529
	RL1608PK-9 RL1608PT-9	RL1608PK	9700519102	DAF 0066873 MAN N1014001718 Mercedes 0002900647
	RL1608PJ-9	RL1608PJ	9700519442	DAF 1519291 Iveco 93161820 RVI 5001842847
	RL1608PG-9 RL1608PH-9	RL1608PG RL1608PH	9700519192	MAN 81307256071
	RL1608PE-9 RL1608PL-9	RL1608PE RL1608PL	9700519062	Scania 550457
	RL1608CA-9	RL1608CA	184613	MAN M2000, L2000
	RL1608FA-9	RL1608FA		

Pipe Connector		8.02
		RL1111AA
	Ports: M16x1.5 Female Hose: Dia 7	
Cross Ref.	8916500714	
		RL1111CA
	Thread: M16x1.5 Male Hose: Dia 14	
Cross Ref.	7995	
		RL1111BA
	Ports: M16x1.5 Male Hose: Dia 10	
		RL1111BC
	Ports: M16x1.5	
		RL1111BA01
	Thread Hole: Φ 13, Φ 11	





Clutch Master Cylinder		8.03
		RLWM084-1605010
	Description : 23.81 Mounion Size: 60, 2x 9 Connetcing Size: M14x1.5 , 10	
Application	DAF 1265209	

	RLWM023-1605010
	Cylinder Bore : 19.05 Mounion Size: 60, 2x 9,45° Coupling Dimension: M12x1-6H M22x1.5-6H Working Stroke: 38mm
	RLWM082-1605010
	Description : 23.81 Mounion Size: 45 ,2xM6-6H Connetcing Size: M14x1-6H, 12.5
	RLWM036-1605010
	Cylinder Bore : 20.64 Mounion Size: 83, 2x 10.5 Coupling Dimension: M12x1.5-6H, 12 Working Stroke: 34mm
	RLWM039-1605010
	Cylinder Bore : 28.58 Mounion Size: 60 , 2- 8.5 Coupling Dimension: 3/4-16UNF 1/2-20UNF Working Stroke: 34mm
	RLWM044-1605010
	Cylinder Bore : 23.81 Mounion Size: 4- 9, 60 Coupling Dimension: M12x1.5-6H Working Stroke: 32mm
	RLWM046-1605010
	Cylinder Bore : 25.4 Mounion Size: 68, 3x 9 Coupling Dimension: M14x1.5-6H Working Stroke: 38mm
	RLWM069-1605010
	Cylinder Bore : 22.22 Mounion Size: 45, 2xM6-6H Coupling Dimension: M14x1-6H, 12.5

Shift Knob		8.04
		RLD5-Z100
Application	Scania	A-6913
		RLD5-Z101
Application	Scania	A-6915
		RLD5-Z110
Application	Fuller	A6909
		RLD5-Z102
Application	MAN	

		RLD5-Z111
Application	Fuller	A6910
		RLD5-Z113
Cross Ref.	4630490500	
Application	Volvo F12	1655853
		RLD5-Z118
Cross Ref.	4630550500	
Application	Volvo F12-10	1655854

Shift Knob		8.04
RLD5-Z112		
		
Application	Volvo	20488052 1521394 3192255
	Scania	
RLD5-Z120		
		
Cross Ref.		4630550520
Application	Volvo	1665981 1655981
RLD5-Z121		
		
Application	Volvo	20488063 20493844
RLD5-Z122		
		
Application	Volvo	20488061

RLD5-Z123		
		
Application	Volvo	20488058
RLD5-Z124		
		
Application	MAN	81326200049
RLD5-Z125		
		
Application	MAN	81326200043 81326200039 81326200085
RLD5-Z126		
		
Application	MAN	8132620045 8132620083

Shift Knob		8.04
RLD5-Z127		
		
Application	MAN	81326200095
RLD5-Z128		
		
Application	Fuller	A4900
RLD5-Z129		
		
Application	Fuller	A5010
RLD5-Z130		
		
Application	Scania	1727377

RLD5-Z131		
		
Application	Scania	1441235
RLD5-Z136		
		
Application	Eaton, Fuller	A7318
RLD5-Z137		
		
Application	Eaton, Fuller	A7315
RLD5-Z138		
		
Application	Eaton, Fuller	A7313

Shift Knob		8.04
RLD5-Z139		
		
Application	Renault	7420915349
RLD5-Z090		
		
Cross Ref.	112113142143	
Application	Scania 3 Series	6202600040

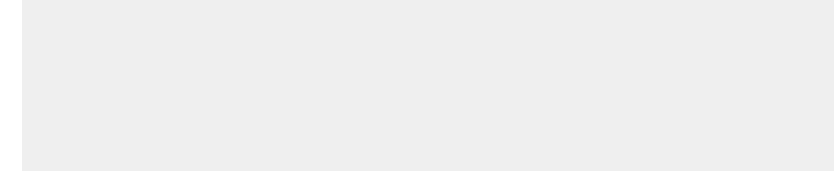



Trailer Coupling		9
Shut Off Cock		9.01
Coupling Head		9.02
Coupling Bracket		9.03
Line Filter		9.04
Cable Spiral		9.05
Power Cable		9.06
Air Hose		9.07
Electric Cable		9.08
Connecting Cable		9.09



Shut Off Cock		9.01
RL3520AA		
	Ports: M22x1.5	
Cross Ref.	4520021070	
Alternative	4520021320	
Application	Scania	124978
	Volvo	351565
	Iveco	1121692
RL3520AA05		
	Ports: M22x1.5	
Cross Ref.	4520021330	
Application	Universal	
RL3520AA07		
	Ports thread: M22x1.5	
Cross Ref.	4520021310	
Application	Neoplan	110264100
	Scania	1424404
RL3517AA		
	Thread: 1=M22x1.5, 2=M16x1.5	



RL3520AB	
	Ports: 1+2=M22X1.5
Cross Ref.	4756040110
Alternative	BR1105, 352008002
Application	Scania 1010125
RL3520AB-A	
	Ports: 1+2=M22x1.5
Cross Ref.	4756040100
Alternative	BR1100
Application	Mercedes B950826401201
	Iveco 1271399
RL3520DA	
	Adjustment Empty: 1.42.8BAR Adjustment 1/2 Laden: 3.4...4.3BAR Empty Pre-set: 2.1bar Ports 1,2: M22x1.5 Comments: Without Release Position
Cross Ref.	4756040130
Alternative	BR1306, 352008031 ,210001041
Application	Scania 1010126



Coupling Head		9.02
RL3521AA		
	Ports: M22x1.5 Characteristic: Red-no Check Comment: Trailer Application - ISO1728	
Cross Ref.	334026011	
Alternative	4522000110	
Application	Trailer	
RL3521AF		
	Ports: M16x1.5 Characteristic: Red-no Check	
Cross Ref.	334026031	
Alternative	4522000110	

Coupling Head		9.02
RL3521AH		
	Port: M18x1.5 Characteristic: Chalkiness	
Application	Trailer	
RL3521AJ		
Port: NPT1/2 Characteristic: Red		
RL3521AA01		
	Port: NPT1/2 Characteristic: Black	
RL3521AC		
	Ports: 1/2"NPT	
RL3521AC02		
Port: M22x1.5		
RL3521AB		
	Ports: M22x1.5 Characteristic: Yellow-no Check Comment: Trailer Application - ISO1728	
Cross Ref.	334025011	
Alternative	4522000110	
Application	American Trailer	





RL3521AG		
Ports: M16x1.5 Characteristic: Yellow-no Check		
Cross Ref.	334025031	
Alternative	9522000220	
Application	American Trailer	
RL3521AK		
Port: NPT1/2 Characteristic: Yellow		
RL3521AK-A		
	Port: NPT1/2 Characteristic: Blue	
Application	Trailer	
RL3521BA02		
	Port: M16x1.5 Characteristic: Yellow	
Application	Trailer	
RL3521BA		
	Ports: M22x1.5 Characteristic: Red With Check	
Cross Ref.	4522002110	
Application	DAF	109915
	Volvo	1505064

Coupling Head		9.01
RL3521BA-A		
	Ports: M16x1.5 Characteristic: Red With Check	
Cross Ref.	4522002210, 9522002210	
Alternative	KU4124, 334063001	
Application	Scania	318158
	Volvo	6888509
	Iveco	2515298
RL3521BA-B		
Port: NPT1/2 Characteristic: Red With Check		
RL3521BA39		
	Port: NPT1/2 Dust Cap: Red	
Application	Kamaz	
RL3521BB		
	Ports: M22x1.5 Characteristic: Red Without Check	
Application	DAF	109912
	MAN	88512206003
RL3521BB-A		
Ports: M16x1.5 Characteristic: Red Without Check		
Cross Ref.	9522000210, 45222000210	
Alternative	334026021, KU1307	
Application	DAF	1506435
	Iveco	41035633
	MAN	81512206049

RL3521BB01	
	Ports: M22x1.5
Cross Ref.	4522000000
Alternative	200006031, KU1300
Application	DAF 1506066
	Iveco 03350313
	EvoBus 8283220000
RL3521BC	
	Ports: M16x1.5 Characteristic: Yellow With Check
Cross Ref.	4522002220, 9522002220
Alternative	KU4128, 334064001
Application	Scania 318159
	Volvo 6888511
	Iveco 2515210
RL3521BC-A	
Ports: M22x1.5 Characteristic: Yellow With Check	
Application	Truck
RL3521BC-B	
Port: NPT1/2 Characteristic: Yellow With Check	
Application	DongFeng



Coupling Head		9.02
RL3521BD		
	Ports: M22x1.5 Characteristic: Yellow Without Check	
Cross Ref.	4522000120	
Application	DAF	109913
RL3521BD-A		
	Ports: M16x1.5 Characteristic: Yellow Without Check	
Cross Ref.	9522000220	
Alternative	KU1306, 334025031	
Application	Scania	330302
	Iveco	2379560
RL3521EA01		
	Ports: M16x1.5 Female, M24x1.5 Male Characteristic: Red With Check	
Cross Ref.	9522010020	
Alternative	KU1400	
Application	Scania	1788946
RL3521EA02		
	Ports: M16x1.5 Female, M24x1.5 Male Characteristic: Yellow With Check	
Cross Ref.	9522010010	
Alternative	KU1410	
Application	DAF	1518206
	MAN	81998062077

	RL3521DB
	Port: 1/2" NPT Characteristic: Blue Comment: 11452
Cross Ref.	278523
Application	American Trailer
	RL3521DA
	Port: 1/2"NPT Characteristic: Red Comment: 11451
Cross Ref.	278524
Application	American Trailer
	RL3521DC
	Port: 1/2"NPT
Cross Ref.	275150
Application	American Trailer
	RL3521NA01
	Ports: 1/2NPT Characteristic: Red
Cross Ref.	11445P
	RL3521NA02
	Ports: 3/8NPT Characteristic: Red
Cross Ref.	11441P

Dual Coupling		9.02
		RL3521CB
Ports: M16x1.5 Comment: Trailer Portion		
Cross Ref.	4528040120	
Application	Mercedes	0014290430
	Krone	945403
		RL3521CD
Ports: Dia 10 Hose Tails Comment: Trailer Portion		
		RL3521CA
Ports: M22x1.5 Inside Thread: M16x1.5		
Cross Ref.	4528020070	
Alternative	4528020090	
Application	DAF	1325341
	Iveco	41285154
	MAN	81512206120
	Mercedes	0004294530
Repair Kit	RL3521CA-9	
		RL3521CC
Ports: M22x1.5 Inside Thread: NPT1/4		
Cross Ref.	4528020000	
Application	Scania	202213
	Volvo	350471 6213539

		RL3521CA03
Port: M22x1.5-6g		
Cross Ref.	4528030050	
Application	DAF	1325338
	Mercedes	B919025111601
		RL3521CD04
Ports: M16x1.5-6H		
Cross Ref.	4528050040	
Application	DAF	1325339
	MAN	81512206027
	Mercedes	0004299830
	Scania	373402
	Volvo	1622573
		RL3521CE
Ports: M22x1.5 Male Or 1/4"NPT Female Comment: Truck Portion		
Cross Ref.	4528060000	
Application	Trailer	
		RL3521CF
Ports: Dia 10 Hose Tails Comment: Trailer Portion		
Cross Ref.	4528080020	
Application	Trailer	

Repair Kits	Kits P/N	Repair Kits For	Cross Ref.	Application
	RL3521CA-9	RL3521CA	4528020032	Scania 325167 DAF 1506071

Coupling Bracket		9.03
		RL3521ZZ011
	Ports: 1/2-14 NPSF	
Cross Ref.	T420	
Application	American Trailer	
		RL3521ZZ012
Ports: 1/4-18 NPSF		
Cross Ref.	T423	
Application	American Trailer	
		RL3521ZZ013
	Ports: 1/2"-14NPSF	
Cross Ref.	T422	
Application	American Trailer	
		RL3521ZZ014
Ports: 1/4"-18NPSF		
Cross Ref.	T424	
Application	American Trailer	

		RL3521ZZ015
	Ports: 1/2-14" NPTF Ports: 3/4-14 "NPTF	
Cross Ref.	T428	
Application	American Trailer	
		RL3521ZZ017
	Ports: 1/2-14" NPTF Ports: 3/4-14 "NPTF	
Cross Ref.	T429	
Application	American Trailer	

Line Filter		9.04
		RL3515ZA
	Ports 1, 2 M22x1.5	
Cross Ref.	4325000200	
Alternative	AE4100, 211001001	
Application	Scania 631697 RVI 23170600 Volvo 1591031 MAN 1065220 Iveco 2494274	
		RL3515ZB
Ports 1, 2 M16x1.5		
Cross Ref.	4325000210	
Alternative	310007001	
Application	RVI 5021170084 DAF 1325344	

Pressure Regulator With Filter 9.04	
RL3531QA	
	Ports: SUPPLY=3/8 NPT Delivery=1/8"NPT Comment: Set (4.0 - 4.4) bar
Cross Ref.	A4740
Application	American Trailer

Cable Spiral 9.05	
3550 625 045 0	
	Voltage: 24V, 5 Pin Length 4500mm
Cross Ref.	4460082300, 4460082340
Application	DAF 0891489 Iveco 42095121 Mercedes 0005401639 RVI 5000790594

3550 625 045 8	
	
Cross Ref.	4460083902
Application	DAF 1506025 Schmitz 7788088000



Power Cable 9.06	
3550 620 060 0	
	Voltage: 24V Length 6000mm ISO7638 power cable with ISO7638 plug, powercable ECU plug & pilot lamp
Application	ABS

3550 620 080 0	
	Voltage: 24V Length 8000mm ISO7638 power cable with ISO7638plug, powercable ECU plug & pilot lamp
Application	ABS
3550 620 120 0	
	Voltage: 24V Length 12000mm ISO7638 power cable with ISO7638plug, powercable ECU plug & pilot lamp
Application	ABS
3550 620 055 0	
	Voltage: 24V Length 5000mm ISO7638 power cord with ISO7638 plug According to the requirement of factory.
Cross Ref.	4491420500
Application	CNHTC AZ9719770051
3550 621 055 0	
	Voltage: 12V Length 5000mm ISO7638 power cord with ISO7638 plug According to the requirement of factory.
3550 620 056 0	
	Voltage: 24V Length 6000mm ISO7638 power cord with ISO7638 plug According to the requirement of factory.
3550 621 056 0	
	Voltage: 12V Length 6000mm ISO7638 power cord with ISO7638 plug According to the requirement of factory.
Cross Ref.	4491520600
Application	Truck, Trailer



Power Cable		9.06
		3550 623 060 0
	Voltage: 24V ISO7638 power cable with	
Cross Ref.	4491120600	
Application	Trailer	
		3550 623 080 0
		Voltage: 24V Specifications: ISO7638 power cord with ISO7638 plug, power
Cross Ref.	4491120800	
Application	Trailer	
		3550 623 120 0
		Voltage: 24V Specifications: ISO7638 power cord with ISO7638 plug, power
Cross Ref.	4491121200	
Application	Trailer	

Air Hose		9.07
		RLD5-F007
	Remark: RED M16x1.5	
Cross Ref.	AF116M22R	
		RLD5-F007A
		Remark: RED 1/2NPT
Cross Ref.	AF116M22R	

		RLD5-F007B
		Remark: RED M22x1.5
Cross Ref.	AF116M22R	
		RLD5-F009
	Remark: Skyblue M16x1.5	
		RLD5-F009A
		Remark: Skyblue 1/2NPT
		RLD5-F009B
		Remark: Skyblue M22x1.5
		RLD5-F006
	Remark: Blue M16x1.5	
		RLD5-F006A
		Remark: Blue 1/2NPT
		RLD5-F006B
		Remark: Blue M22x1.5

Air Hose		9.07
		RLD5-F008
Remark: Yellow M16x1.5		
Cross Ref.	AF116M22J	
		RLD5-F008A
Remark: Yellow 1/2NPT		
Cross Ref.	AF116M22J	
		RLD5-F008B
Remark: Yellow M22x1.5		
Cross Ref.	AF116M22J	

Electric Cable		9.08
		RLD5-F005
Remark: Black		
		RLD5-F005A
Remark: Black With Connector		
		RLD5-F010
Remark: Black		
		RLD5-F010A
Remark: Black With Connector		

Connecting Cable Socket		9.09
		3550 620 120 8
Voltage: 24V		
Cross Ref.	4460083802	
Application	SXHTC	P29100710003
		3550 910 600 2
Voltage: 24V		
Cross Ref.	4460086002	
Application	Trailer	

Bus Specific Devices		10
Door Control Valve		10.01

Door Control Valve		10.01
		RL8606JA
All Ports: 7xM12x1.5 Installation Thread: M10 Working Voltage: 24V		
Cross Ref.	4720174800	
Application	DAF, Iveco, Volvo, Neoplan	
	Mercedes	0007600378
	MAN	81749206017
	Schmikz	86331010000
		RL8606JB
All Ports: 7xM12x1.5 Installation Thread: M10 Working Voltage: 12V		
Cross Ref.	4720174810	
Application	Mercedes	0007600278
	Neoplan	1102525543712
	Volvo	589990049970
		RL8606HC
All Ports: 7xM12x1.5 Installation Thread: M10 Working Voltage: 24V		
Cross Ref.	KN0481500101	
Application	Mercedes	8633135000
	Iveco	71300013
	RVI	5000790025

Universal Application Devices 11

Check Valve	11.01
Double Check Valve	11.02
TR-3 Inversion Valve	11.03
Synchro Valve	11.04
Control Cylinder	11.05
Double Acting Cylinder	11.06
Exhaust Brake Valve	11.07
Directional Control Valve	11.08
Gearbox Valve	11.09
Trasmission Slave Valve	11.10
Follow-up Valve	11.11
Control Valve	11.12
Electronic Valve	11.13
Proportional Valve	11.14

Check Valve 11.01



Ports: 1+2=M22x1.5

RL3525AA

Cross Ref.	314001001	
Application	Foton	1417035600060



Ports: 1+2=M22x1.5

RL3525HA01

Cross Ref.	4340140010	
Application	RVI	5010056474
	DAF	0266860
	MAN	84521206013
	Mercedes	A0024290444
	Neoplan	110250700
Repair Kit	RL3525HA01-9	



Ports: 2xM22x1.5

RL3525HA02

Cross Ref.	4340141000, 4340140000	
Alternative	AE5115	
Application	DAF	1505039
	MAN	88521206006
	Mercedes	0034290744
	Neoplan	11017367



Inlet: 1/2"NPT
Outlet: 1/2"NPT

RL3525CA01

Cross Ref.	800376
Application	American Trailer



Inlet: 1/2"NPT
Outlet: 1/2"NPT

RL3525CA02

Cross Ref.	227871
Application	American Trailer



Port 1 thread: M22x1.5
Ports 21, 22 thread: M16x1.5
Port 23 thread: M14x1.5
Port 24 thread: M12x1.5



RL3525CA03

Application	Mercedes	0024299644
-------------	----------	------------



Check Valve		11.01
RL3525CA04		
	Inlet Port: 1/2 NPT Outlet Port: 1/2NPT	
Cross Ref. Application	800372 Universal	
RL3525CA05		
	Ports: NPT3/8	
Cross Ref. Application	800373 Universal	
RL3525CA06		
	Supply: M22x1.5 M12x1.5 Delivery 21,22,23,24: M22x1.5	
Application	Universal	
RL3525CC01		
	All ports thread: NPT3/4	
Cross Ref. Application	800369 Universal	





RL3525CC02	
	All ports thread: NPT1/4
Cross Ref. Application	801144 Universal
RL3525ZA	
	Ports: Supply+Delivery=1/2"NPT
Cross Ref. Application	KN23000, 227871 Universal
RL3525ZB	
	Ports: Supply+Delivery=3/8"NPT
Cross Ref. Application	KN23010, 227870 Universal
RL3525ZA05	
	Port 1: NPT3/4 Port 2: NPT3/4 Cut-off Pressure: 30kPa
Cross Ref. Application	KN23040 Universal

Check Valve		11.01	
	RL3525DB		
	Ports: 1=M22x1.5 Female 2=M22x1.5 Male		
RL3525DC			
Ports: 1=M22x1.5 FEMALE 2=M16x1.5 Male			
	RL3525FA		
	Ports: 1+2=3/8" NPT		
Application	HINO	44510-1190	
RL3525FB			
Ports: 1+2=M16x1.5			
Application	HINO		

	RL3525YA		
	Ports: 1+2=M16x1.5		
Application	HINO		
RL3525YB			
Ports: 1+2=3/8" NPT			
Application	HINO	44510-1090	
	RL3525GA		
	Port 1: M22x1.5 Port 2: M22		
Cross Ref.	KW4648/1		
Application	Trailer		

Repair Kit	Kits P/N	Repair Kits For	Cross Ref.	Application
	RL3525HA01-9	RL3525HA01	4340140092	DAF 06934000 RVI 5000589024

Double Check Valve		11.02
RL3533AA		
	Ports: 11, 12, 2=3/8 NPT	
Application	King Long	
RL3533AC		
	Ports: 11, 12, +2=M16x1.5	
Cross Ref.	4342080090	
Application	RVI	5000436340
	Volvo	1505044
RL3533AE		
	Ports: 11, 12, +2=M22x1.5	
Cross Ref.	4342080000	
Alternative	AE4105, 333001001	
Application	RVI	5000039138
	Volvo	79379137
RL3533AA16		
	Port 1: M16x1.5 Port 2: NPT3/8	
Cross Ref.	35GC2-33010	
Application	XiaMen King Long	

RL3533GA	
	Ports: 11, 12, +2=3/8"NPT
Cross Ref.	295036, 280479
Application	American Trailer
RL3533GC	
	Ports: 3xM16x1.5
Cross Ref.	295358
Application	Scania
RL3533GB	
	Ports: 11, 12, +2=1/4" NPT
Application	HINO 44080-1010 Mitsubishi MC820241
RL3533KA	
	Ports: 11, 12, +2=3/8"NPT
Cross Ref.	320100
Application	American Trailer
RL3533MA	
	Ports: 11, 12, +2=M16X1.5
Cross Ref.	205004001
Application	Trailer

DC-4 Double Check Valve 11.02	
	RL3533HA Ports: 11, 12, +2=3/8" PT
Cross Ref.	278614
Application	American Trailer
	RL3533HB Ports: 11, 12, +2=M16x1.5
Cross Ref.	278597
Application	American Trailer
	RL3533HC Ports: 11, 12, +2=1/4"PT
Cross Ref.	278615
Application	American Trailer
	RL3533HA02 Ports: 11, 12, +2=3/8"NPT
Cross Ref.	278614
Application	American Trailer
	RL3533HA01 Ports: 11, 12, +2=1/4"NPT
Cross Ref.	278615
Application	American Trailer



	RL3533JF Ports: Port11, 12, 21 3/8"NPT Port 22: 1/4"NPT
Application	American Trailer
	RL3533JC Ports11, 3/8"PT Ports 12, 21, 22: 1/4"PT
Cross Ref.	268597
Application	American Trailer
	RL3533JF03 Port 11:3/8"NPT Ports12, 21, 22: 1/4"NPT
Cross Ref.	268597
Application	American Trailer
	RL3533JE Ports: All 3/8"PT
Cross Ref.	280809
Application	American Trailer





DC-4 Double Check Valve 11.02	
RL3533JF01	
	Ports: All 3/8"NPT
Cross Ref.	280809
Application	American Trailer
RL3533JD	
	Ports11, 22, 21 3/8"PT Port12 1/4"PT
Cross Ref.	278598
Application	American Trailer
RL3533JF02	
	Ports11, 12, 21 3/8"NPT Port12 1/4"NPT
Cross Ref.	278598
Application	American Trailer
RL3533JB	
	Ports11 1/2"PT Port21, 22 3/8"PT Port12 1/4"PT
Cross Ref.	278596
Application	American Trailer

RL3533JF04	
	Port11 1/2"NPT PortS21, 22 3/8 Port12 1/4"NPT
Cross Ref.	278596
Application	American Trailer
RL3533JA	
	Ports11 1/2"PT Port12, 21, 22 1/4"PT
Cross Ref.	278595
Application	American Trailer
RL3533JF05	
	Port11 1/2"NPT Ports12, 21, 22 1/4"NPT
Cross Ref.	278595
Application	American Trailer

Double Check Valve 11.02	
RL3533LA	
	Ports: 11, 12, +2=M22x1.5
Cross Ref.	4342080290
Alternative	AE4100, 333001001
Application	RVI 5000039183 Volvo 21795800 MAN 8154306043 Iveco 1236222

Double Check Valve		11.02	
		RL3533LB22	
		Ports: 11, 12, +2=M16x1.5	
Cross Ref.	4342080300		
Application	DAF	1619672	
	Mercedes	0044292244	
		RL3533NA01	
		Ports: All M14x1.5	
Cross Ref.	5340170090		
Application	Scania	1519035	
	Iveco	2514861	

TR-3 Inversion Valve		11.03	
		RL3533EA01	
		Supply: 1/4"PT Delivery: 1/4"PT Control: 1/8"PT Psi A: 25, psi B: 40 Note.: With Common Control & Supply Pressure Inlet Opens At"A" psi Descending Pressure And Exhaust Opens At "B"psi, Ascending Pressure	
Cross Ref.	281459		
Application	American Trailer		
		RL3533EA05	
		Supply: 1/4"NPT Delivery: 1/4"NPT Control: 1/8"NPT Psi A: 25 , psi B: 40 Note.:With Common Control & Supply Pressure Inlet Opens At"A"psi Descending Pressure And Exhaust Open S At"B"psi, Ascending Pressure	
Cross Ref.	281459		
Application	American Trailer		



SV-1 Synchro Valve		11.04	
		RL3533EB	
		Ports: SUP, DEL CON=1/4"PT Exh=1/8"PT Psi A: 42 Psi B: 28	
Cross Ref.	278825		
Application	American Trailer		
		RL3533EA02	
		Ports: SUP, DEL, CON=1/4"NPT EXH=1/8"NPT Psi A: 42 Psi B: 28	
Cross Ref.	278825		
Application	American Trailer		
		RL3533ED	
		Ports: SUP, DEL, CON=1/4"PT Exh=1/8"PT Psi A: 21 Psi B: 11	
Cross Ref.	282472		
Application	American Trailer		
		RL3533EA03	
		Ports: SUP, DEL, CON=1/4"NPT Exh=1/8"NPT Psi A: 21 Psi B: 11	
Cross Ref.	282472		
Application	American Trailer		

SV-1 Synchro Valve		11.04
RL3533EF		
	Rod End: M12 Ports: SUP, DEL, CON=1/4" PT Exh=1/8"PT Psi A: 62 Psi B: 50	
Cross Ref.	283700	
Application	American Trailer	
RL3533EA04		
	Ports: SUP, DEL, CON=1/4"NPT, EXH=1/8"NPT Psi A: 62 Psi B: 50	
Cross Ref.	283700	
Application	American Trailer	
RL3533EA		
	Ports: SUP, DEL, CON=1/4"NPT	
Application	Mitsubishi	MC821909

Control Cylinder		11.05
RL2135CA		
	Rod End: M12 Ports: M12x1.5 Dia: 35mm	
Cross Ref.	4214110200	
Application	Mercedes	0004300126
	Bosch	0482006009





	RL2135CC03	
	Rod End: M12 Ports: M12x1.5 Dia: $\Phi 35$ Stroke: $\leq 88\text{mm}$	
	RL2135CE07	
	Rod End: M8 Ports: M12x1.5 Dia: $\Phi 24$ Stroke: 51mm	
	RL2135DA	
	Rod End: M8 Ports: M12x1.5(6L) Dia: 28mm	
Cross Ref.	SZ1114	
Alternative	4214290000, 4214290030	
Application	Mercedes	0004301826
	MAN	81157016003
	RL2135TB01	
	Ports: RC1/8 Dia: 17mm	
Application	MAN	81521706142
	RL2135EA	
	Rod End: M6 Ports: M12x1.5(6L) Dia: 24mm Comment: Diameter(ΦA): 10.8	
		
Cross Ref.	SZ1115	
Application	Mercedes	0000720112
	MAN	81117016046
	Iveco	2248786

Control Cylinder		11.05
		RL2135EB03 Rod End: M6 Ports: M12x1.5(6L) Dia: 24mm Comment: Diameter(ΦA): 12.5
		RL2135EB Rod End: M8 Ports: M12x1.5(6L) Dia: 24mm Comment: Diameter(ΦA): 10.8
Cross Ref.	SZ1159	
Application	Mercedes	A0000721512
		RL2135CE04 Rod End: M8 Ports: M12x1.5(6L) Dia: 24mm Comment: Diameter(ΦA): 12.5
		RL2135EA08 Port thread M12x1.5 Push rod thread: M6
		RL2135FC Ports: M12x1.5
		Cross Ref. 4214120000 Alternative 341006001, SZ1300 Application Mercedes 0003530255
		RL2135FD Ports: M10x1

		RL3535DA Ports: M12x1.5
		RL3549GB Ports: 1/8"NPT
Application	Mitsubishi	ME063715
		RL3535FC01 Ports: M12x1.5





Double Acting Cylinder		11.06
		RL3535FA Ports: 41+42=M12x1.5
Cross Ref.	4220100100	
Application	DAF	106321
	Iveco	02981151
	MAN	81327356011
	Mercedes	0002600863
	Neoplan	050113145
		RL3535FA02 Control Port 41,42: M12x1.5 Fork Hole Dia.: F12
Cross Ref.	4220100120	
Application	DAF	1517945
	Mercedes	0002602803
	RVI	5001000746

Double Acting Cylinder		11.06
		RL3535GA
Ports: 41+42=M1x1.5		
Cross Ref.	4220100140	
Application	DAF	1517946
	Mercedes	0002607063
	ZF	0501002209
		RL3535FA03
Port 41,42: M12x1.5		
Application	Mercedes	0002604663

Exhaust Brake Valve		11.07
	RL3549FK03	
	Diam. 80mm Cylinder Inlet Port 1: M18x1.5	
Cross Ref.	X8837200	
Application	Ashok Leyland	
	RL3549JL01	
	Diam. 64mm Cylinder Inlet Port 1: NPT1/8	
Cross Ref.	1106935000004	
Application	Foton Ollin	
	RL3549JL02	
	Dia. 64mm Cylinder Inlet Port 1: M10x1-6G	
Cross Ref.	13072350M0088	
Application	Foton Rowor I Foton Rowor III -190	
	RL3549JL03	
	Dia. 64mm Cylinder Inlet Port: NPT1/8	
Cross Ref.	F5820350X0009	
Application	Foton Rowor P140	
	RL3549JA	
	Diam: 84mm Cylinder inlet port 1: M10x1-6G	
Application	FAW J6	





	RL3549BB01	
	Dia.100mm Cylinder Inlet Port 1: M10x1-6H	
Cross Ref.	1424135641001	
Application	Foton Auman 6 Series Root Van (BJ1317vnpjj-19) Foton Auman Dump (BJ3258dlpjb-19)	
	RL3549ZB01	
	Diam.100mm Cylinder Inlet Port 1: NPT1/8	
Application	CNHTC Howo Foton 1425135680020	
	RL3549FK02	
	Dia.100mm Cylinder Inlet Port 1: M10x1-6G	
Application	FAW Sailong II Truck 3523010-50A	

Directional Control Valve		11.08
	RL3548UB01	
	Port 1 thread: M10x1, M12x1.5 Port 2 thread: M12x1.5	
Cross Ref.	4342050320	
Application	DAF 1517987 Scania 1373080 1503897	

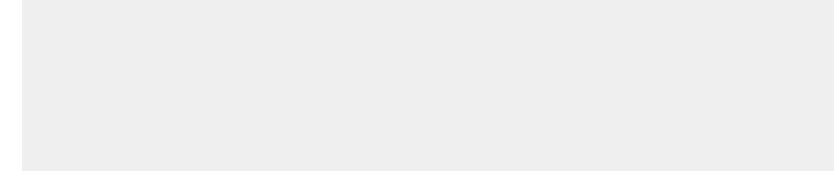
Directional Control Valve 11.08	
	<p>RL3548AF</p> <p>Ports 1,2,3: M12x1.5 Comment: L=37.9-Steel Button</p> <p>Repair Kit RL3548AF-9</p>
	<p>RL3548AG</p> <p>Ports 1,2,3: M12x1.5 Comment: L=95.6</p> <p>Cross Ref. 4630131140 Alternative AE1207 Application Volvo 1132041 DAF 1518078 Mercedes 0004300509</p> <p>Repair Kit RL3548AG-9</p>
	<p>RL3548AG1</p> <p>Ports 1,2,3: M12x1.5 Comment: L=95.6-Aluminium Stem</p>
	<p>RL3548AF1</p> <p>Ports 1,2,3: M12x1.5 Comment: L=46.9mm</p>
	<p>RL3548AG09</p> <p>Ports 1,2,3: All M12x1.5 Stroke: 5.7mm Comment: L=37.9mm</p>

	<p>RL3548AG02</p> <p>Ports 1,2,3: M12x1.5 Comment: L=37.9mm</p> <p>Cross Ref. 4630131120 Alternative AE1206, 332005011 Application RVI 5021170180 Volvo 6645266 MAN 4086378 Iveco 2564591</p>
	<p>RL3548AG22</p> <p>Ports 1, 2, 3: M12x1.5 Working Stroke: (5.7 ± 0.3)mm</p> <p>Cross Ref. 4630131160 Application DAF 0639394 Iveco 02564591 MAN 236950 Mercedes 0004340501 Neoplan 11017347</p>
	<p>RL3548NA</p> <p>Ports 1,2: M16x1.5 Voss Port 3: M12x1.5</p> <p>Cross Ref. 4630132000 Application DAF 1505077 Mercedes 0004343801</p>
	<p>RL3548MA</p> <p>Ports 1,2: M10x1</p> <p>Cross Ref. 4630220200 Application DAF 0642909 Volvo 268759</p> <p>Repair Kit RL3548MA-9</p>







Directional Control Valve		11.08	
		RL3548PA	
		Ports 1,21: M16x1.5 Voss, 22,3: M12x1.5	
Cross Ref.	4630132100		
Application	DAF	1505078	
	Mercedes	0039977036	
		RL1705CA	
		Ports 1,2: M10x1	
Cross Ref.	4630360000		
Alternative	AE1111		
Application	RVI	5000806404	
	MAN	81521866015	
	Iveco	2140302017	
Repair Kit	RL1705CA-9		
		RL1705CA07	
		Ports 1, 2: $\Phi 7.3$ Installation hole: 2xM6 Comment: Without quick connector	
Cross Ref.	4630360240		
Application	Iveco	500356849	
	MAN	81521856060	
		RL1705CA08	
		Ports 1/2 thread: M16x1.5	
Cross Ref.	4630360160		
Application	DAF	1518851	
	MAN	N2521706021	
	Schmitz	051265	
	Volvo	20453076	

		RL1705CA09	
		Ports 1, 2 thread: M12x1.5 Stroke: (4.5 ± 0.8) mm	
Cross Ref.	5801279152		
Application	Iveco		

3/2 Directional Control Valve		11.08	
		RL1705CB	
		Ports 1,2: M16x1.5 Voss Port 3: M10x1	
Cross Ref.	4630360050		
Application	DAF	1506104	
	Mercedes	0039972226	

4/3 Directional Control Valve		11.08	
		RL1705UA	
		Ports 1, 21, 22: M10x1	
Cross Ref.	4630370010		
Application	DAF	1518085	
	Mercedes	0019979136	

Directional Control Valve		11.08
	RL1705FA	
	All Ports: 1/8" NPT	
RL1705FB		
All Ports: 1/4"NPT		
	RL1705JD01	
	All Ports: 1/4"NPT Installation hole: $\phi 7$	
Cross Ref.	90554615	
Application	Truck	
	RL1705AB	
	All Ports: 1/8" NPT	
Application	Mercedes	0012607257
	Fuller	F96387
	RL1705BA	
	All Ports: M10x1	
Cross Ref.	5710031040	
Application	RVI	5000455080
	MAN	81327346001
	Iveco	02968407





	RL1705DA	
	All Ports: 1/8"NPT	
Application	Mercedes	G155, G210
	RL1705PA01	
	Port 1,2,3: M14x1.5 Port 12: M10x1	
Cross Ref.	5710400000	
Alternative	554005001	
Application	Scania	262083
	Schmitz	050515
	RL1705QA01	
	Port 1: M12x1.5 Port 41: M10x1	
Application	MAN	81521316015
	ZF	050128630
	RL1705QA05	
	Port 1: M12x1.5 Port 41: M10x1 With O-ring $\phi 7.5 \times \phi 2.5$	
Application	Iveco	42558601
		42535033
	ZF	0501215359
	RL1705QA03	
	Port: M10x1 Installation hole: $\phi 6$	
Application	MAN	81521706127
	ZF	0501310059

Directional Control Valve		11.08	
RL1705RA			
	Port 1: M12x1.5 Port 41: M10x1		
Cross Ref.	4630630030		
Application	Mercedes	0012603157	
	ZF	0501204597	
Repair Kit	RL1705RA-9		
RL1705RB			
Ports 1: M12x1.5 Port 41: M10x1			
Cross Ref.	4630630020		
Application	DAF	1518090	
	Mercedes	0012600657	
Repair Kit	RL1705RB-9		

Gearbox Valve		11.09	
RL1705WA			
	Ports: M12x1.5		
Cross Ref.	SV3302		
Alternative	4630281600		
Application	DAF	0609715	
	Mercedes	0012602757	
		0002604757	
	MAN	81327346007	
	RVI	5000587747	
Repair Kit	RL1705WA-9		
RL1705XA			
	Ports 1,21,22: M12x1.5		
Cross Ref.	SV3371		
Application	Mercedes	0012608457	
Repair Kit	RL1705XA-9		

RL1705YA			
	Ports: M12x1.5		
Cross Ref.	SV3360		
Alternative	4630460030		
Application	Mercedes	0012600057	
	Iveco	42486086	
Repair Kit	RL1705YA-9		
RL1705ZA			
	Port 1: M12x1.5 Ports 21,22: M14x1.5		
Cross Ref.	SV3367		
Application	Mercedes	0012606757	
Repair Kit	RL1705ZA-9		
RL1705ZA02			
	Port: M12x1.5 Port 21,22: M14x1.5		
Cross Ref.	6038202043		
Application	ZF		
RL1705ZA03			
	Ports 21,22: M14x1.5 Port: M12x1.5		

Gearbox Valve		11.09	
		RL1705JE01	
		All ports thread: 4xM10x1	
Application	RVI	5000673571	
		RL1705ZB01	
		Ports 1,21,22: F10	
Application	Mercedes	0022606157	
		RL1705JA01	
		Ports: 1/8"NPT	
Application	Scania	1319557	
		RL1705MA01	
		Supply 1: 1/8" PT Delivery 2: 1/8" PT	
Application	Volvo	1068951 1669297 8172627	
		RL1705TA01	
		Port: 1,2 M10x1,M16x1.5	
Application	Volvo	1669277 3092123	

		RL1705TA03	
		Ports 1, 2: Φ 10.1	
Cross Ref.		1672231	
Application		Volvo	
		RL1704BA	
		Ports: Control-RC 1/4"RC	
Cross Ref.		X3099-350	
Repair Kit		RL1704BA-9	
		RL1704EA01	
		Ports: M12x1.5	
Application	Mercedes	0002606263	
Repair Kit		RL1704EA-9	
		RL1704DA	
		Ports: Control-RC1/4 Installation Plate Hole: Φ 10.5	
Cross Ref.		670046	
Application		Nissan, HINO	
		RL1704DB	
		Ports: Control-RC1/4 Installation Plate Hole: Φ 10.5	
Application	Nissan	43431-76000	

Transmission Slave Valve		11.10
	RL1705NA01	
	Ports: 1/8"NPT	
Cross Ref.	A5000	

Follow-up Valve		11.11
	RL1705JC01	
	Ports 1,21,22: M12x1.5	
Cross Ref.	SV3336	
Application	MAN	81521636006
	Iveco	504010668



Control Valve		11.12
	RL1705SA01	
	Port: Connection For Plastic Tube(6mm)	
Application	MAN	81521706156









	RL1705GA	
	Pipe.: $\phi 4$	
Cross Ref.	463 069 003 0	
Application	Mercedes	0012606357

	RL1705GA02	
Cross Ref.	43-088	



	RL3548TC01	
	Supply: M10x1 Delivery 2: M10x1	
Cross Ref.	1653156	
Application	Volvo	

	RL3548UA01	
	Port 1: 1/8"NPT Ports 21,22: 1/8"NPT	
Application	King Long Dong Feng Trailer	





Repair Kit	Kits P/N	Repair Kits For	Cross Ref.	Application
	RL1705CA-9	RL1705CA		
	RL1705ZA-9	RL1705ZA		



Repair Kits	Kits P/N	Repair Kits For	Cross Ref.	Application
	RL1705RA-9 RL1705RB-9	RL1705RA RL1705RB	4630630002	DAF 0697317 Mercedes 0002604368
	RL1705WA-9	RL1705WA		DAF
	RL1705YA-9	RL1705YA		
	RL1705XA-9	RL1705XA		
	RL1704EA-9	RL1704EA01		
	RL1704BA-9	RL1704BA		
	RL3548AF-9 RL3548AG-9	RL3548AF RL3548AG	4630130042	Scania 282508 Volvo 11993596 Iveco 42487120
	RL3548MA-9	RL3548MA	4630130052	





Control Valve		11.10
		RL3548JA01
	All Ports: 1/4"PT Installation Hole: 1/4-20UNC-2B	
Cross Ref.	101860	
		RL3548UA02
	Inlet: 1/8"NPT Outlet: 1/8"NPT	
Cross Ref.	WM1397JN	





PP-5 Control Valve		11.12
		RL3548FA03
	Port 1,2,3: 1/8-28"PT Auto Release: 20psi	
		RL3548FA05
	Sup: 1/8"NPT Del: 1/8"NPT	
Application	Trailer	
		RL3548FA04
		Sup: 1/8"PT Del: 1/8"PT
Application	Trailer	

		RL3548FA10
	Supply: 1/8"NPT Delivery: 1/8"NPT Exhaust: 1/8"NPT	
Cross Ref.	275176	
Application	Trailer	
		RL3548FA11
	Supply: 1/8"NPT Delivery: 1/8"NPT Exhaust: 1/8"NPT	
Application	Trailer	
		RL3548FA12
	Sup: 1/8"NPT Del: 1/8"NPT Exh: 1/8"NPT Auto Release: 40psi	
Application	Trailer	
		RL3548FA13
	Sup: 1/4"NPT Del: 1/4"NPT Exh: 1/4"NPT Auto Release: 20psi	
Application	Trailer	





Control Valve		11.12	
		RL3548FA14	
		Sup: 1/8-28"PT Del: 1/8-28"PT Exh: 1/8-28"PT Auto Release: 40psi	
Application	Trailer		
		RL3548FA15	
		Sup: 1/8"NPT Del: 1/4"NPT Exh: 1/4"NPT Auto Release: 40psi	
Application	Trailer		
		RL3548FA16	
		Sup: 1/8-28"PT Del: 1/4"PT Exh: 1/8-28"PT Auto Release: 40psi	
Application	Trailer		
		RL3548FA17	
		Sup: 1/8"NPT Del: 1/8"NPT Exh: 1/8"NPT Auto Release: 20psi	
Application	Trailer		

		RL3548FA18	
		Sup: 1/8"NPT Del: 1/8"NPT Exh: 1/8"NPT Auto Release: 20psi	
Application	Trailer		
		RL3548FA19	
		Sup: 1/8-28"PT Del: 1/8-28"PT Exh: 1/8-28"PT Auto Release: 40psi	
Application	Trailer		
		RL3548FA20	
		Sup: 1/8-28"PT Del: 1/8-28"PT Exh: 1/8-28"PT Auto Release: 20psi	
Application	Trailer		
		RL3548FA21	
		Sup: 1/8-28"PT Del: 1/8-28"PT Exh: 1/8-28"PT Auto Release: 20psi	
Application	Trailer		

Control Valve		11.12
		RL3548FA22
Sup: 1/8"PT Del: 1/4"PT Exh: 1/8"PT		
Application	American Trailer	
		RL3548FA25
All Ports: 1/8"NPT Handle cover yellow color		
Application	Trailer	
		RL3548FA27
Sup: 1/8-28"PT Del: 1/8-28"PT Exh: 1/8-28"PT Auto Release: 40psi		
Application	Trailer	
		RL3548FA24
All Ports: 1/8-28"PT Handle cover red color		
Application	Trailer	
		RL3548FA28
All Ports: 1/8"NPT Handle cover red color		
Application	Trailer	

		RL3548FA41
Sup: 1/8"NPT Del: 1/8"NPT Exh: 1/8"NPT Auto Release: 40psi		
Cross Ref.	276462	
Application	Trailer	
		RL3548FB
Ports: SUP+DEL=RC1/4		
Application	ISUZU	1-48460-198-0
	Nissan	45260-00200
Repair Kit	RL3548FB02-8	
		RL3548FC
Ports: SUP+DEL=RC1/4		
Application	ISUZU	1-48460-145-0
Repair Kit	RL3548FC02	
		RL3548FD-B
Ports 1,2: 1/8"NPT Port 3: 1/8"PT Auto Release: 20psi		
Application	King Long	



Control Valve		11.12
		<p>RL3548FD-C</p> <p>Ports 1,2: 1/8"NPT Port 3: 1/8"PT Auto Release: 40psi</p>
		<p>Application King Long</p>
		<p>RL3548FH</p> <p>All Ports: 1/8"NPT Pop Pressure: (35±10)psi</p>
		<p>Cross Ref. KN20021</p>
		<p>RL3548FH-A</p> <p>All Ports: 1/8"NPT Pop Pressure: (35±10)psi</p>
		<p>Cross Ref. KN20022</p>
		<p>RL3548BA01</p> <p>Ports 1, 2: M22x1.5 Port 4: M16x1.5</p>
		<p>Cross Ref. K010108A Application Mercedes AXOR</p>
		<p>RL3548BA02</p> <p>Ports 1, 2: M22x1.5 Port 4: M16x1.5</p>
		<p>Cross Ref. K010108B1 Application Mercedes AXOR</p>

Control Valve		11.12
		<p>RL3548WC04</p> <p>Supply: 1/8"NPT Delivery: 1/4"NPT Exhaust : 1/4"NPT Control: 1/8"NPT</p>
		<p>Cross Ref. 287280</p>
		<p>RL3548FA-C</p> <p>Ports: SUP+DEL+EXH=1/8"NPT</p>
		<p>Cross Ref. 278450 Application American Trailer</p>
		<p>RL3548FA</p> <p>Ports: SUP+DEL+EXH=1/8"PT</p>
		<p>Cross Ref. 278450 Application American Trailer</p>
		<p>RL3548FE</p> <p>Ports: SUP+DEL=1/8" NPT EXH=1/4"NPT Auto Release: 40 psi</p>
		<p>Application American Trailer</p>
		<p>RL3548FA07</p> <p>Ports: SUP+EXH=1/8"NPT DEL=1/4"NPT Auto Release: 40 psi</p>
		<p>Cross Ref. 287600 Application American Trailer</p>

PP-1 Control Valve		11.12
	RL3548FD	
	Ports: SUP+DEL+EXH=1/8" PT Auto Release: 20 psi	
	Cross Ref.	276566
	Application	American Trailer
		RL3548FD-D
		Ports: SUP+DEL+EXH=1/8"NPT Auto Release: 20 psi
Cross Ref.	276566	
Application	American Trailer	
		RL3548FD-E
		Ports: SUP+DEL+EXH=1/8"NPT Auto Release: 40 psi
Cross Ref.	276567	
Application	American Trailer	
		RL3548FD-A
		Ports: SUP+DEL+EXH=1/8" PT Auto Release: 40 psi
Cross Ref.	276567	
Application	American Trailer	

		RL3548FA-A
		Ports: SUP+DEL=1/8" NPT EXH=1/8"PT Auto Release: 60 psi
Cross Ref.	283828	
Application	American Trailer	
		RL3548FA08
		Ports: SUP+DEL+EXH=1/8"NPT Auto Release: 60 psi
Cross Ref.	283828	
Application	American Trailer	
		RL3548FA-B
		Ports: SUP+EXH=1/8"NPT DEL=1/4"NPT Auto Release: 30 psi
Cross Ref.	287417	
Application	American Trailer	
		RL3548FA09
		Ports: SUP+EXH=1/8"NPT DEL=1/4"NPT Auto Release: 30 psi
Cross Ref.	287417	
Application	American Trailer	

PP-8 Control Valve		11.12
		RL3548CA01
		Supply: 1/8"PT Delivery: 1/8"PT Exhaust: 1/8"PT
Cross Ref.	287238	
		RL3548CA02
		Supply: 1/8"NPT Delivery: 1/8"NPT Exhaust: 1/8"NPT
Cross Ref.	287238	

Transmission Splitter Valve		11.12
		RL3548DH01
Cross Ref.	19974	
		RL3548DH02
Cross Ref.	4300810	

PP-3 Control Valve		11.12
		RL3548DA01
		Supply: 1/8"PT Delivery: 1/4"PT Exhaust: 1/4"PT
Cross Ref.	288746	
		RL3548DA02
		Supply: 1/8"NPT Delivery: 1/4"NPT Exhaust: 1/4"NPT
Cross Ref.	288746	

PP-5 Control Valve		11.12
		RL3548EA01
		Supply: 1/8"PT Delivery: 1/8"PT Pilot Air Inlet: 1/8"PT
Cross Ref.	281946	
		RL3548EA02
		Supply: 1/8"NPT Delivery: 1/8"NPT Pilot Air Inlet: 1/8"NPT
Cross Ref.	281946	

PP-7 Control Valve		11.12
RL3548WC		
	Ports1, 4=1/8"PT Ports 3, 21=1/4"PT Auto Release: 40 psi	
Cross Ref.	288241	
RL3548WC-A		
	Ports1, 4=1/8"NPT Ports3, 21=1/4"NPT Auto Release: 40 psi	
Cross Ref.	288241	
RL3548WD		
	Ports1, 4=1/8"PT Port 21=1/4"PT Auto Release: 40 psi	
Cross Ref.	288239	
RL3548WD-A		
	Ports1,4=1/8"NPT Port 21=1/4"NPT Auto Release: 40 psi	
Cross Ref.	288239	





Control Valve		11.12
RL3548QA		
	Ports: 1+12+3=M16x1.5	
Cross Ref.	352019001	
Alternative	207013001	
Application	Trailer	

RL3548QB	
	Ports: 11+2+12=M16x1.5
Cross Ref.	352018001, 207012001
Alternative	9630060010
Application	American Trailer
RL3548QC	
	Ports: SUPP+DEL=M10x1
Application	Trailer
RL3548QD	
	Ports: ALL=NPT3/8
Application	Trailer
RL3548HA	
	Ports: 1+2=RC1/4, 3=RC1/8
Cross Ref.	03342-14000
Application	Trailer

Control Valve		11.12
RL3548HB		
	Ports: 1+2=RC1/4, 3=RC1/8	
Application	HINO	47930-1070
RL3548YA		
	Ports: SUP+DEL=1/4" NPT	
Application	Mitsubishi Nissan	MC804585 45260-Z2000
RL3548YB		
	Ports: SUP+DEL=1/4"NPT Pop Pressure: (7-17) psi	
Cross Ref.	KN20033	
RL3548YB-A		
	Ports: SUP+DEL=1/4"NPT Pop Pressure: (25-35)psi	
Cross Ref.	KN20031	

RL3548GA	
	Ports: SUP+DEL=M14x1.5-6H Comment: With Push To Release Plate
Application	HINO, ISUZU
RL3548GB	
	Ports: SUP+DEL=1/4"NPT Comment: With Push To Release Plate
Cross Ref. Application	17600B HINO, ISUZU
RL3548LC01	
	Supply: 1/8"PT Delivery: 1/8"PT
Cross Ref. Application	A3546 American Trailer
RL3548LC02	
	Supply: 1/8"NPT Delivery: 1/8"NPT
Cross Ref. Application	A3546 American Trailer

Electronic Valve		11.13
	RL3754ES01	
	DC: 24V Ports 1,12,21,22: 1/8"NPT Installation Holes: 4xΦ7	
Application	Scania	1488083
	RL3754ES02	
	All Ports thread: 1/8"NPT Installation hole: Φ7 DC 24V	
Application	Scania	1423566
	RL3754ES03	
	Ports 1, 21, 22 thread: 1/4"NPT Port 4 thread: 1/8"NPT DC 24V	
Application	DAF 95	1303948, 1457275
	RL3754ES04	
	Ports 1, 21, 22 thread: NPT 1/4 Port 4 thread: NPT 1/8, DC 24V	
Application	DAF, XF	1379776, 1457276

	RLD5-R043	
	M27*1-6G	
	RLD5-R044	
Cross Ref.	3549010-C4	
Application	WuZheng	
	RLD5-R048	
	Voltage: 24V Air Circuit Type: Normally Closed Type Inlet Port Dia.: Φ4 Exhaust Port Dia.: Φ4	
Cross Ref.	4720706390	
Application	Mercedes	0059971236
	RLD5-R049	
	Voltage: 24V Air Circuit Type: Normally Closed Type Inlet Port Dia.: Φ2.2 Exhaust Port Dia.: Φ3	
Cross Ref.	4720726390	
Application	Mercedes	
	RLD5-R050	
	Voltage: 24V Air Circuit Type: Normally Closed Type Inlet Port Dia.: Φ4 Exhaust Port Dia.: Φ4	
Cross Ref.	4721706060	
Application	King Long	35K63-51010
	Yu Tong	3506-00563, HINO
	CNHTC	VG1557090015/1

Electronic Valve		11.13	
	RLD5-R051		
	Voltage: 24V Air Circuit Type: Normally Closed Type Inlet Port Dia.: Φ 4mm Exhaust Port Dia.: Φ 4mm		
Cross Ref.	4721706160		
Application	DAF	1306727	
	Mercedes	0049979336	
	RLD5-R052		
	Voltage: 24V Air circuit type: Normally Opened Type		
Cross Ref.	4721707960		
	RLD5-R053		
	Voltage: 24V Air Circuit Type: Normally Opened Type Inlet Port Dia.: Φ 2.2mm Exhaust Port Dia.: Φ 2.2mm		
Cross Ref.	4721710000		
Application	Nissan		
	RLD5-R054		
	Voltage: 24V Air Circuit Type: Normally Opened Type Inlet Port Dia.: Φ 2.2mm Exhaust Port Dia.: Φ 2.2mm		
Cross Ref.	4721717000		
Application	Mercedes	0049978936	
	Iveco	41016827	

	RLD5-R055		
	Voltage: 24V Air Circuit Type: Normally Opened Type Inlet Port Dia.: Φ 2.2mm Exhaust Port Dia.: Φ 2.2mm		
Cross Ref.	4721717060		
Application	DAF	1315508	
	RLD5-R056		
	Voltage: 24V Air Circuit Type: Normally Closed Type Inlet Port Dia.: Φ 2.2mm Exhaust Port Dia.: Φ 3mm		
Cross Ref.	4721726060		
Application	DAF	1315507	
	RLD5-R057		
	Voltage: 24V Air Circuit Type: Normally Closed Type Inlet Port Dia.: Φ 2.2mm Exhaust Port Dia.: Φ 3mm		
Cross Ref.	4721716860		
	RLD5-R058		
	Voltage: 24V Air Circuit Type: Normally Opened Type Inlet Port Dia.: Φ 4mm Exhaust Port Dia.: Φ 4mm		
Cross Ref.	4721732260		
Application	Iveco	41026588	

Electronic Valve		11.13	
		RLD5-R059	
		Voltage: 24V Air Circuit Type: Normally Closed Type Inlet Port Dia.: Φ 2.2mm Exhaust Port Dia.: Φ 2.2mm	
Cross Ref.	4721727860		
Application	DAF	1315510	
		RL3754ET01	
		Voltage: 24V All Ports: 3xM12x1.5 Working Pressure: (5-13)bar	
Cross Ref.	T.1610566		
		RLD5-R061	
		Voltage: 24V Air Circuit Type: Normally Closed Type Inlet Port Dia.: Φ 2.2mm Exhaust Port Dia.: Φ 2.2mm	
Cross Ref.	4721271400		
Application	DAF	736924	
	Mercedes	0009974036	
	Schmitz	82832250000	
	Krone	945406	
	Kogel	75378	
		RLD5-R100	
Cross Ref.	4120000367		

Proportional Valve		11.14	
		RL3754PT01	
		Ports 1, 2: M12x1.5, DC: 24V Plug Three Pin	
Cross Ref.	4722500030		
Application	DAF	1525456	
	Iveco	98417040	
		RL3754PT02	
		Ports 1, 2: M12x1.5, DC: 24V Electrical Connections: M27x1	
Cross Ref.	4722500000		
Application	DAF	1505432	
	Iveco	4460001016	
	MAN	1170242	
	Mercedes	6644297082	
	Scania	1335961	
	Volvo	3127660	

Repair Kits	Kits P/N	Repair Kits For	Cross Ref.	Application
	RL3548FB02-8			
	RL3548FC02		248502	American Trailer
	RL3548FD02		248433 KN20901	American Trailer
	RL3548FD03		290655	American Trailer
	RL3548FH317		KN20903	American Trailer

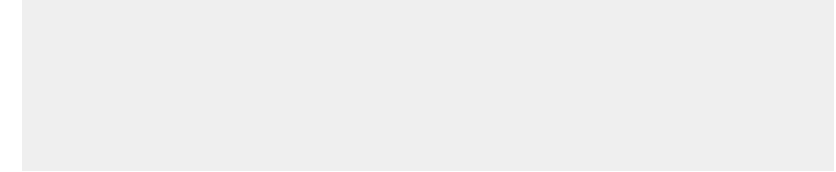

Brake Acutation 12	
Yoke	12.01
Brake Chamber(Disc Brake)	12.02
Brake Chamber(Wedg Brake)	12.03
Brake Chamber(Cam Brake)	12.04
Spring Brake(Disc Brake)	12.05
Spring Brake(Wedge Brake)	12.06
Spring Brake(Cam Brake)	12.07
Diaphragm	12.08

Yoke 12.01	
L-5	
Cross Ref.	4230005342
Application	Mercedes 6984200047 Scania 1019361 RVI 5000809566 Volvo 526031307000
L-6	
Cross Ref.	4230005352
Application	Scania 1019575 RVI 5021170044



SORL No.	Picture	Dimensions				
		B	C	D	M	L
T-03	1	16(5/8")	33	14	5/8-18 UNF	47
T-05	2	12	33	13	M16X1.5	54
T-09	2	14	28	14.5	M14X1.5	49
A-1	3	12	28	12.5	M16X1.5	43
T-07	4	14	46-112	15	M16X1.5	54-120
D-9	5	14	57	14	M16X1.5	73
D-17	5	12.7(1/2")	57	14	5/8-18 UNF	73
T-08	6	14	56	15	M16X1.5	65
T-06	7	12	28	14	M16X1.5	43
T-02	8-Busil Type	12.5(1/2")	33	15	5/8-18 UNF	49
K-5	9	12.5(1/2")	31	15	5/8-18 UNF	44
T-04	10	12	28.5	15	5/8-18 UNF	45
T-01	11-Busil Type	12	33	15	M16X1.5	49
T-10	11	14	33	15	M16X1.5	46
K-1	SORL:K-1(9)	16	33	14	5/8-18 UNF	47
M-1	SORL:M-1(9)	12.5	33	14	5/8-18 UNF	43



SORL	Type	Stroke	Port Thread	Push Rod Length	Port / Clamp Angle	Cross	Application
RL3519HB01	14	57mm	M16x1.5	15mm	90° / 135°	3519001-BQ01D	
RL3519HB02	14	57mm	M16x1.5	15mm	90° / 225°	3519002-BQ01D	



SORL	Type	Stroke	Port Thread	Push Rod Length	Port / Clamp Angle	Cross	Application
RL3519HB03	14	57mm	2xM16x1.5	15mm	0° / 45°	Alternative 30714200	
RL3519HB04	14	57mm	2xM16x1.5	15mm	0° / 45°	Alternative 30714400	



SORL	Type	Stroke	Port Thread	Push Rod Length	Port / Clamp Angle	Cross	Application
RL3519HA24	16	70mm	M16x1.5	15mm	90° / 120°	(BS3300)	20.3454107530



SORL	Type	Stroke	Port Thread	Push Rod Length	Port / Clamp Angle	Cross	Application
RL3519HA11	16	65mm	2xM16x1.5	15mm	0° / 345°	4231047100	DAF 1505241 Mercedes 0064205224



SORL	Type	Stroke	Port Thread	Push Rod Length	Port / Clamp Angle	Cross	Application
RL3519HA27	16	57mm	M16x1.5	15mm	0° / 0°	3519VS04A-001	
RL3519HA28	16	57mm	M16x1.5	15mm	0° / 0°	3519VS04A-002	



SORL	Type	Stroke	Port Thread	Push Rod Length	Port / Clamp Angle	Cross	Application
RL3519HA24-A	16	57mm	2xM16x1.5	15mm	0° / 45°	Alternative 30716200	
RL3519HA30	16	57mm	2xM16x1.5	15mm	0° / 45°	Alternative 30716600	
RL3519HA32	16	57mm	2xM16x1.5	15mm	90° / 135°	Alternative 01.116.00.05	



SORL	Type	Stroke	Port Thread	Push Rod Length	Port / Clamp Angle	Cross	Application
RL3519HA29	16	64mm	M16x1.5	15mm	0° / 45°	3519-00648	



SORL	Type	Stroke	Port Thread	Push Rod Length	Port / Clamp Angle	Cross	Application
RL3519JA61	18	60mm	M16x1.5	15mm	45° / 270°		
RL3519JA62	18	60mm	M16x1.5	15mm	135° / 180°		



SORL	Type	Stroke	Port Thread	Push Rod Length	Port / Clamp Angle	Cross	Application
RL3519JA22	20	64mm	2xM16x1.5	15mm	0° / 340°	4235050000	DAF 1517954 MAN N2504016063 Mercedes 0074201224



SORL	Type	Stroke	Port Thread	Push Rod Length	Port / Clamp Angle	Cross	Application
RL3519JA41	20	64mm	M16x1.5	15mm	0° / 225°	3519-00377	Yutong
RL3519JA42	20	64mm	M16x1.5	15mm	0° / 135°	3519-00818	Yutong
RL3519JA48	20	64mm	2xM16x1.5	15mm	0° / 45°	3519NS28W-010	Dongfeng
RL3519JA49	20	64mm	2xM16x1.5	15mm	0° / 270°	3519NS28W-015	Dongfeng
RL3519JA52	20	70mm	M16x1.5	15mm	60° / 60°	QT50CQK2-3519010	FAW Qingdao
RL3519JA53	20	70mm	M16x1.5	15mm	120° / 300°	QT50CQK2-3519020	FAW Qingdao
RL3519JA56	20	70mm	M16x1.5	15mm	60° / 60°	HD90009368000	Shaanxi Auto
RL3519JA57	20	70mm	M16x1.5	15mm	120° / 300°	HD90009368001	Shaanxi Auto



SORL	Type	Stroke	Port Thread	Push Rod Length	Port / Clamp Angle	Cross	Application
RL3519JA66	20	70mm	M16x1.5	15mm	0° / 45°	3519ZDS08B-010	Dongfeng
RL3519JA67	20	70mm	M16x1.5	15mm	0° / 315°	3519ZDS08B-015	Dongfeng



SORL	Type	Stroke	Port Thread	Push Rod Length	Port / Clamp Angle	Cross	Application
RL3519JA45	20	64mm	M16x1.5	15mm	0° / 225°	3519JS15A-001	Dongfeng
RL3519JA46	20	64mm	M16x1.5	15mm	0° / 135°	3519JS15A-002	Dongfeng

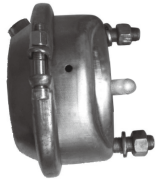

SORL	Type	Stroke	Port Thread	Push Rod Length	Port / Clamp Angle	Cross	Application
RL3519JA47	20	64mm	M16x1.5	15mm	0° / 45°	57306159	
RL3519JA50	20	64mm	M22x1.5	15mm	0° / 180°	WG9000360410	Howo
RL3519JA51	20	64mm	M22x1.5	15mm	0° / 180°	WG9000360420	Howo
RL3519JA54	20	60mm	M16x1.5	15mm	166° / 60°	3519011RL	NanJing Iveco
RL3519JA55	20	60mm	M16x1.5	15mm	14° / 134°	3519010RL	NanJing Iveco



SORL	Type	Stroke	Port Thread	Push Rod Length	Port / Clamp Angle	Cross	Application
RL3519AM05	24	64mm	M16x1.5	15mm	160° / 270°		
RL3519AM06	24	76mm	M16x1.5	15mm	20° / 90°		
RL3519AM11	24	70mm	2xM16x1.5	15mm	0° / 340°	4235060010	BPW
RL3519AM29	24	65mm	M16x1.5	15mm	120° / 300°	Similar with 4235061500	
RL3519AM30	24	65mm	2xM16x1.5	15mm	60° / 60°	Similar with 4235061510	



SORL	Type	Stroke	Port Thread	Push Rod Length	Port / Clamp Angle	Cross	Application
RL3519AM37	24	65mm	2xM16x1.5	15mm	90° / 180°	4235060020	Kamaz 4308,07, Sauer 4454106900



SORL	Type	Stroke	Port Thread	Push Rod Length	Port / Clamp Angle	Cross	Application
RL3519AM31	24	64mm	M16x1.5	15mm	0° / 225°		Yutong
RL3519AM32	24	64mm	M16x1.5	15mm	35° / 345°	3519-00605 3519010ZYT-D	Yutong NanJing Iveco
RL3519AM33	24	64mm	M16x1.5	15mm	325° / 15°	3519-00606 3519011ZYT-D	Yutong NanJing Iveco
RL3519AM35	24	64mm	M16x1.5	15mm	15° / 15°	3519010-01L	FAW
RL3519AM36	24	64mm	M16x1.5	15mm	165° / 345°	3519010-01R	FAW



SORL	Type	Stroke	Port Thread	Push Rod Length	Port / Clamp Angle	Cross	Application
RL3519AM38	24	60mm	M16x1.5	15mm	160° / 90°	3519NP15-010	Dong feng
RL3519AM39	24	60mm	M16x1.5	15mm	20° / 90°	3519NP15-015	Dong feng
RL3519AM40	24	65mm	M16x1.5	15mm	147° / 147°	QT75AQ26-3519010	Shaanxi Auto
RL3519AM41	24	65mm	M16x1.5	15mm	33° / 33°	QT75AQ26-3519020	Shaanxi Auto



SORL	Type	Stroke	Port Thread	Push Rod Length	Port / Clamp Angle	Cross	Application
RL3519DA35	30	60mm	M16x1.5	46mm	30° / 225°	4230570080	Trailer



SORL	Type	Stroke	Port Thread	Push Rod Length	Port / Clamp Angle	Cross	Application
RL3519DA75	30	54mm	M16x1.5	48mm	0° / 60°	3519010J-0A2200	Dongfeng
RL3519DA76	30	60mm	M16x1.5	15mm	90° / 90°	55000091	XuZhou Meritor



SORL	Type	Stroke	Port Thread	Push Rod Length	Port / Clamp Angle	Cross	Application
RL3519HA13	16	57mm	M16x1.5			57RS304407	



SORL	Type	Stroke	Port Thread	Push Rod Length	Port / Clamp Angle	Cross	Application
RL3519AK (Left)	24	58mm	M16x1.5		130° / 260°	K412-93900Z10	TBK
RL3519AK-A (Right)	24	58mm	M16x1.5		50° / 100°	K412-94000Z10	TBK



SORL	Type	Stroke	Port Thread	Push Rod Length	Port / Clamp Angle	Cross	Application
RL3519NA	12	57mm	2xM16x1.5	186mm	0° / 45°	4231039000	DAF 1505025 RVI 5021170046 MAN 81511016203



SORL	Type	Stroke	Port Thread	Push Rod Length	Port / Clamp Angle	Cross	Application
RL3519NA2	12	54mm	M16x1.5	42mm	0° / 180°		



SORL	Type	Stroke	Port Thread	Push Rod Length	Port / Clamp Angle	Cross	Application
RL3519NA3	12	57mm	2xM16x1.5	186mm	0° / 45°		



SORL	Type	Stroke	Port Thread	Push Rod Length	Port / Clamp Angle	Cross	Application
RL3519NA11	12	57mm	2xM16x1.5	33mm	0° / 0°	4231030090	Truck



SORL	Type	Stroke	Port Thread	Push Rod Length	Port / Clamp Angle	Cross	Application
RL3519HA1	16	57mm	2xNPT3/8	270mm	90° / 135°		
RL3519HA2	16	57mm	2xNPT1/4	270mm	90° / 135°		



SORL	Type	Stroke	Port Thread	Push Rod Length	Port / Clamp Angle	Cross	Application
RL3519HA3	16	57mm	2xM16x1.5	270mm	90° / 135°	Alternative 423 104 606 0	Mercedes
RL3519HA4	16	57mm	2xNPT3/8	270mm	90° / 135°		



SORL	Type	Stroke	Port Thread	Push Rod Length	Port / Clamp Angle	Cross	Application
RL3519HA7-B	16	57mm	2xNPT3/8	270mm	90° / 135°		



SORL	Type	Stroke	Port Thread	Push Rod Length	Port / Clamp Angle	Cross	Application
RL3519HA9	16	57mm	M16X1.5	38.5mm	0° / 0°		



SORL	Type	Stroke	Port Thread	Push Rod Length	Port / Clamp Angle	Cross	Application
RL3519HA10	16	57mm	2xM16x1.5	340mm	90° / 135°		



SORL	Type	Stroke	Port Thread	Push Rod Length	Port / Clamp Angle	Cross	Application
RL3519HA14	16	57mm	2xNPT3/8	71.5mm	0° / 0°	43-439	American



SORL	Type	Stroke	Port Thread	Push Rod Length	Port / Clamp Angle	Cross	Application
RL3519HH40	16	54mm	M18x1.5	72mm	0° / 90°		



SORL	Type	Stroke	Port Thread	Push Rod Length	Port / Clamp Angle	Cross	Application
RL3519YA1	16	75mm	2xM16x1.5	186mm	0° / 225°	4231049000	DAF 0834481 MAN 81511016172 Scania 1010153



SORL	Type	Stroke	Port Thread	Push Rod Length	Port / Clamp Angle	Cross	Application
RL3519JA1	20	54mm	2xM16x1.5	270mm	0° / 45°		
RL3519JA2	20	54mm	2xM16x1.5	60mm	0° / 45°		



SORL	Type	Stroke	Port Thread	Push Rod Length	Port / Clamp Angle	Cross	Application
RL3519JA4	20	54mm	2xNPT3/8	270mm	0° / 45°		
RL3519JA6	20	54mm	2xNPT3/8	200mm	0° / 135°		
RL3519JA10	20	54mm	2xNPT3/8	270mm	90° / 135°		
RL3519JA14	20	54mm	2xNPT3/8	270mm	90° / 90°		
RL3519JA15	20	54mm	2xNPT3/8	270mm	0° / 45°		
RL3519JA16	20	54mm	2xM16x1.5	200mm	0° / 135°		
RL3519JA17	20	54mm	2xNPT3/8	270mm	0° / 45°		



SORL	Type	Stroke	Port Thread	Push Rod Length	Port / Clamp Angle	Cross	Application
RL3519YA2	16	75mm	2xM16x1.5	186mm	0° / 225°		



SORL	Type	Stroke	Port Thread	Push Rod Length	Port / Clamp Angle	Cross	Application
RL3519JA18	20	75mm	2xM16x1.5	186mm	0° / 225°	4231059000	Scania 1738479 DAF 0834482



SORL	Type	Stroke	Port Thread	Push Rod Length	Port / Clamp Angle	Cross	Application
RL3519JA37	20	57mm	M16x1.5	37mm	155° / 320°	4231054060	MAN, NATO, RVI



SORL	Type	Stroke	Port Thread	Push Rod Length	Port / Clamp Angle	Cross	Application
RL3519JA19	20	57mm	M16x1.5	37mm	0° / 0°	4231051110	DAF 1505026 MAN 81511016196 Mercedes 0004207624



SORL	Type	Stroke	Port Thread	Push Rod Length	Port / Clamp Angle	Cross	Application
RL3519JA20	20	60mm	M14x1.5	67mm	0° / 30°		Trailer



SORL	Type	Stroke	Port Thread	Push Rod Length	Port / Clamp Angle	Cross	Application
RL3519JA25	20	60mm	M18x1.5	72mm	0° / 330°	284642100138	



SORL	Type	Stroke	Port Thread	Push Rod Length	Port / Clamp Angle	Cross	Application
RL3519JA28	20	75mm	M16x1.5	186mm	0° / 225°	123200001	



SORL	Type	Stroke	Port Thread	Push Rod Length	Port / Clamp Angle	Cross	Application
RL3519BB-DR	20	45mm	NPT3/8	207mm	165° / 165°	Q1-3519S92NZ-015	Dongfeng



SORL	Type	Stroke	Port Thread	Push Rod Length	Port / Clamp Angle	Cross	Application
RL3519BP	20	60mm	M16x1.5	40mm	0° / 90°		
RL3519BP-A	20	60mm	2xNPT3/8	270mm	0° / 90°		



SORL	Type	Stroke	Port Thread	Push Rod Length	Port / Clamp Angle	Cross	Application
RL3519AA1	24	57mm	M22x1.5	270mm	0° / 0°		
RL3519AA2	24	57mm	2xM16x1.5	270mm	0° / 0°		



SORL	Type	Stroke	Port Thread	Push Rod Length	Port / Clamp Angle	Cross	Application
RL3519AA3	24	57mm	2xM16x1.5	270mm	0° / 0°		



SORL	Type	Stroke	Port Thread	Push Rod Length	Port / Clamp Angle	Cross	Application
RL3519AA8	24	57mm	M16x1.5	270mm	0° / 0°		



SORL	Type	Stroke	Port Thread	Push Rod Length	Port / Clamp Angle	Cross	Application
RL3519AA11	24	57mm	2xNPT3/8	275mm	135° / 135°		



SORL	Type	Stroke	Port Thread	Push Rod Length	Port / Clamp Angle	Cross	Application
RL3519AA12	24	57mm	2xNPT3/8	270mm	90° / 90°		



SORL	Type	Stroke	Port Thread	Push Rod Length	Port / Clamp Angle	Cross	Application
RL3519AA15	24	57mm	2xNPT3/8	270mm	0° / 0°		



SORL	Type	Stroke	Port Thread	Push Rod Length	Port / Clamp Angle	Cross	Application
RL3519AA16	24	57mm	M22x1.5	55mm	0° / 0°		



SORL	Type	Stroke	Port Thread	Push Rod Length	Port / Clamp Angle	Cross	Application
RL3519AA19	24	57mm	M22x1.5	270mm	0° / 0°		



SORL	Type	Stroke	Port Thread	Push Rod Length	Port / Clamp Angle	Cross	Application
RL3519AA25	24	57mm	NPT3/8	270mm	0° / 0°		



SORL	Type	Stroke	Port Thread	Push Rod Length	Port / Clamp Angle	Cross	Application
RL3519AA27	24	57mm	M22x1.5 M16x1.5	270mm	0° / 0°		



SORL	Type	Stroke	Port Thread	Push Rod Length	Port / Clamp Angle	Cross	Application
RL3519AA28	24	57mm	2xNPT3/8	270mm	90° / 135°		



SORL	Type	Stroke	Port Thread	Push Rod Length	Port / Clamp Angle	Cross	Application
RL3519AA30	24	57mm	2xM16x1.5	60mm	0° / 0°		



SORL	Type	Stroke	Port Thread	Push Rod Length	Port / Clamp Angle	Cross	Application
RL3519AA32	24	57mm	2xNPT3/8	270mm	0° / 0°		



SORL	Type	Stroke	Port Thread	Push Rod Length	Port / Clamp Angle	Cross	Application
RL3519AA33	24	57mm	NPT1/4	270mm	0° / 0°		



SORL	Type	Stroke	Port Thread	Push Rod Length	Port / Clamp Angle	Cross	Application
RL3519AA34	24	57mm	NPT3/8	200mm	0° / 135°		



SORL	Type	Stroke	Port Thread	Push Rod Length	Port / Clamp Angle	Cross	Application
RL3519AA38	24	57mm	2xM16x1.5	270mm	90° / 90°		



SORL	Type	Stroke	Port Thread	Push Rod Length	Port / Clamp Angle	Cross	Application
RL3519AA43	24	57mm	NPT3/8	170mm	0° / 0°		



SORL	Type	Stroke	Port Thread	Push Rod Length	Port / Clamp Angle	Cross	Application
RL3519AA46	24	57mm	2xM16x1.5	270mm	0° / 0°		



SORL	Type	Stroke	Port Thread	Push Rod Length	Port / Clamp Angle	Cross	Application
RL3519AA50	24	57mm	2xNPT3/8	270mm	90° / 90°		



SORL	Type	Stroke	Port Thread	Push Rod Length	Port / Clamp Angle	Cross	Application
RL3519AA52	24	57mm	2xM16x1.5	270mm	0° / 0°		



SORL	Type	Stroke	Port Thread	Push Rod Length	Port / Clamp Angle	Cross	Application
RL3519AA88	24	54mm	2xM14x1.5	72mm	0° / 35°		



SORL	Type	Stroke	Port Thread	Push Rod Length	Port / Clamp Angle	Cross	Application
RL3519AM09	24	57mm	M16X1.5	37mm	0° / 0°	4231061060	DAF 1505240 MAN 81511016058 Mercedes 0004208924 Neoplan 080240000 RVI 5000464005



SORL	Type	Stroke	Port Thread	Push Rod Length	Port / Clamp Angle	Cross	Application
RL3519AM08	24	57mm	2xNPT3/8	270mm	90° / 90°		CAMC



SORL	Type	Stroke	Port Thread	Push Rod Length	Port / Clamp Angle	Cross	Application
RL3519AM19	24	75mm	2xNPT3/8	270mm	0° / 0°		



SORL	Type	Stroke	Port Thread	Push Rod Length	Port / Clamp Angle	Cross	Application
RL3519ZA1	24	75mm	2xM16x1.5	186mm	0° / 225°	4231069000	Scania 1010154 RVI 38855200 Volvo 6212188 Iveco 3345108R1 Neoplan 07010024 Mercedes 0014206824



SORL	Type	Stroke	Port Thread	Push Rod Length	Port / Clamp Angle	Cross	Application
RL3519ZA2	24	75mm	M16x1.5	186mm	0° / 135°		



SORL	Type	Stroke	Port Thread	Push Rod Length	Port / Clamp Angle	Cross	Application
RL3519ZA03	24	75mm	2xM16x1.5	186mm	0° / 225°		



SORL	Type	Stroke	Port Thread	Push Rod Length	Port / Clamp Angle	Cross	Application
RL3519DB-E	27	63mm	M16x1.5	95mm	0° / 45°		XuZhou Meritor 55000076



SORL	Type	Stroke	Port Thread	Push Rod Length	Port / Clamp Angle	Cross	Application
RL3519DB-A	27	75mm	M16x1.5	37mm	0° / 0°		Shaanxi 81.51101.6455



SORL	Type	Stroke	Port Thread	Push Rod Length	Port / Clamp Angle	Cross	Application
RL3519DB-C	27	64mm	M22x1.5	184mm	105° / 15°		Foton
RL3519DB-D	27	64mm	M22x1.5	184mm	75° / 165°		Foton



SORL	Type	Stroke	Port Thread	Push Rod Length	Port / Clamp Angle	Cross	Application
RL3519DA1	30	64mm	NPT3/8	270mm	0° / 0°		
RL3519DA2	30	64mm	2xNPT3/8	270mm	0° / 0°		
RL3519DA4	30	64mm	2xM16x1.5	270mm	0° / 0°		



SORL	Type	Stroke	Port Thread	Push Rod Length	Port / Clamp Angle	Cross	Application
RL3519DA3	30	64mm	2xNPT3/8	270mm	0° / 0°		



SORL	Type	Stroke	Port Thread	Push Rod Length	Port / Clamp Angle	Cross	Application
RL3519DA6	30	64mm	2xNPT3/8	270mm	90° / 90°		



SORL	Type	Stroke	Port Thread	Push Rod Length	Port / Clamp Angle	Cross	Application
RL3519DA8	30	64mm	NPT3/8	270mm	0° / 0°		
RL3519DA15	30	64mm	NPT3/8	270mm	0° / 0°		



SORL	Type	Stroke	Port Thread	Push Rod Length	Port / Clamp Angle	Cross	Application
RL3519DA11	30	64mm	2xM16x1.5	270mm	0° / 0°		



SORL	Type	Stroke	Port Thread	Push Rod Length	Port / Clamp Angle	Cross	Application
RL3519DA12	30	64mm	2xNPT3/8	270mm	0° / 0°		



SORL	Type	Stroke	Port Thread	Push Rod Length	Port / Clamp Angle	Cross	Application
RL3519DA16	30	64mm	2xNPT3/8	270mm	0° / 0°		



SORL	Type	Stroke	Port Thread	Push Rod Length	Port / Clamp Angle	Cross	Application
RL3519DA17	30	64mm	2xNPT3/8	270mm	90° / 135°		



SORL	Type	Stroke	Port Thread	Push Rod Length	Port / Clamp Angle	Cross	Application
RL3519DA19	30	64mm	NPT3/8	270mm	0° / 0°		



SORL	Type	Stroke	Port Thread	Push Rod Length	Port / Clamp Angle	Cross	Application
RL3519DA22	30	64mm	2xM16x1.5	270mm	0° / 0°		

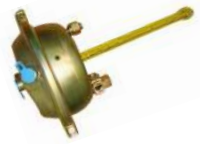

SORL	Type	Stroke	Port Thread	Push Rod Length	Port / Clamp Angle	Cross	Application
RL3519DA24	30	64mm	2xNPT3/8	270mm	90° / 90°		



SORL	Type	Stroke	Port Thread	Push Rod Length	Port / Clamp Angle	Cross	Application
RL3519DA28	30	64mm	M16x1.5	270mm	0° / 0°		



SORL	Type	Stroke	Port Thread	Push Rod Length	Port / Clamp Angle	Cross	Application
RL3519DA29	30	64mm	NPT3/8	270mm	0° / 0°		
RL3519DA30	30	64mm	2xNPT3/8	270mm	90° / 135°		



SORL	Type	Stroke	Port Thread	Push Rod Length	Port / Clamp Angle	Cross	Application
RL3519DA31	30	64mm	2xM16x1.5	270mm	0° / 0°		



SORL	Type	Stroke	Port Thread	Push Rod Length	Port / Clamp Angle	Cross	Application
RL3519DA32	30	64mm	2xNPT3/8	270mm	90° / 90°		



SORL	Type	Stroke	Port Thread	Push Rod Length	Port / Clamp Angle	Cross	Application
RL3519DA33	30	64mm	2xNPT1/4	195mm	0° / 45°		



SORL	Type	Stroke	Port Thread	Push Rod Length	Port / Clamp Angle	Cross	Application
RL3519DA34	30	64mm	2xNPT3/8	270mm	90° / 90°		



SORL	Type	Stroke	Port Thread	Push Rod Length	Port / Clamp Angle	Cross	Application
RL3519DA37	30	64mm	2xNPT3/8	270mm	0° / 0°		



SORL	Type	Stroke	Port Thread	Push Rod Length	Port / Clamp Angle	Cross	Application
RL3519DA38	30	64mm	NPT3/8	182mm	0° / 0°		



SORL	Type	Stroke	Port Thread	Push Rod Length	Port / Clamp Angle	Cross	Application
RL3519DA39	30	57mm	2xNPT3/8	200mm	90° / 135°		



SORL	Type	Stroke	Port Thread	Push Rod Length	Port / Clamp Angle	Cross	Application
RL3519DA40	30	64mm	NPT3/8	270mm	0° / 0°		



SORL	Type	Stroke	Port Thread	Push Rod Length	Port / Clamp Angle	Cross	Application
RL3519DA41	30	64mm	2xNPT3/8	180mm	90° / 135°		



SORL	Type	Stroke	Port Thread	Push Rod Length	Port / Clamp Angle	Cross	Application
RL3519DA42	30	64mm	2xM16x1.5	210mm	0° / 45°		



SORL	Type	Stroke	Port Thread	Push Rod Length	Port / Clamp Angle	Cross	Application
RL3519DA43	30	64mm	NPT3/8	270mm	0° / 0°		



SORL	Type	Stroke	Port Thread	Push Rod Length	Port / Clamp Angle	Cross	Application
RL3519DA45	30	64mm	M16x1.5	95mm	0° / 135°	57RS306150	BMC
RL3519DA47	30	64mm	M16x1.5	95mm	0° / 225°	57RS306151	BMC



SORL	Type	Stroke	Port Thread	Push Rod Length	Port / Clamp Angle	Cross	Application
RL3519DA46	30	64mm	NPT3/8	185mm	0° / 135°		



SORL	Type	Stroke	Port Thread	Push Rod Length	Port / Clamp Angle	Cross	Application
RL3519DA49	30	75mm	2xM16x1.5	186mm	0° / 225°		



SORL	Type	Stroke	Port Thread	Push Rod Length	Port / Clamp Angle	Cross	Application
RL3519DA50	30	64mm	2xM16x1.5	190mm	0° / 45°		



SORL	Type	Stroke	Port Thread	Push Rod Length	Port / Clamp Angle	Cross	Application
RL3519DA51	30	75mm	2xM16x1.5	186mm	0° / 225°	4231079000	RVI 50000815361 Scania 1010155



SORL	Type	Stroke	Port Thread	Push Rod Length	Port / Clamp Angle	Cross	Application
RL3519DA55	30	57mm	2xNPT3/8	254mm	0° / 45°		



SORL	Type	Stroke	Port Thread	Push Rod Length	Port / Clamp Angle	Cross	Application
RL3519DA68	30	64mm	2xNPT3/8	178mm	90° / 45°		



SORL	Type	Stroke	Port Thread	Push Rod Length	Port / Clamp Angle	Cross	Application
RL3519DA-N	30	64mm	2xNPT3/8	278mm	0° / 45°		



SORL	Type	Stroke	Port Thread	Push Rod Length	Port / Clamp Angle	Cross	Application
RL3519DD1	30	57mm	2xNPT3/8	210mm	0° / 45°		



SORL	Type	Stroke	Port Thread	Push Rod Length	Port / Clamp Angle	Cross	Application
RL3519LA	36	64mm	2xNPT3/8	225mm	0° / 90°		
RL3519LA1	36	64mm	2xNPT3/8	270mm	0° / 90°		
RL3519LA2	36	64mm	2xNPT3/8	270mm	0° / 90°		



SORL	Type	Stroke	Port Thread	Push Rod Length	Port / Clamp Angle	Cross	Application
RL3519LA10	36	75mm	2xM16x1.5	184mm	0° / 30°		
RL3519LA12	36	75mm	2xNPT3/8	270mm	90° / 90°		
RL3519LC	36	75mm	2xM22x1.5	184mm	0° / 30°		
RL3519LC27	36	75mm	2xM16x1.5	200mm	0° / 30°		



SORL	Type	Stroke	Port Thread	Push Rod Length	Port / Clamp Angle	Cross	Application
RL3519LA11	36	64mm	NPT3/8	270mm	0° / 90°		



SORL	Type	Stroke	Port Thread	Push Rod Length	Port / Clamp Angle	Cross	Application
RL3519WA	150	72mm	M22x1.5	48.4mm			



SORL	Type	Stroke	Port Thread	Push Rod Length	Port / Clamp Angle	Cross	Application
RL3519WD		40mm	M16x1.5	84.5mm	0° / 225°		

Remarks:

- The following diagram shows mounting angle and port angle.
- Modification of mounting angle is available.

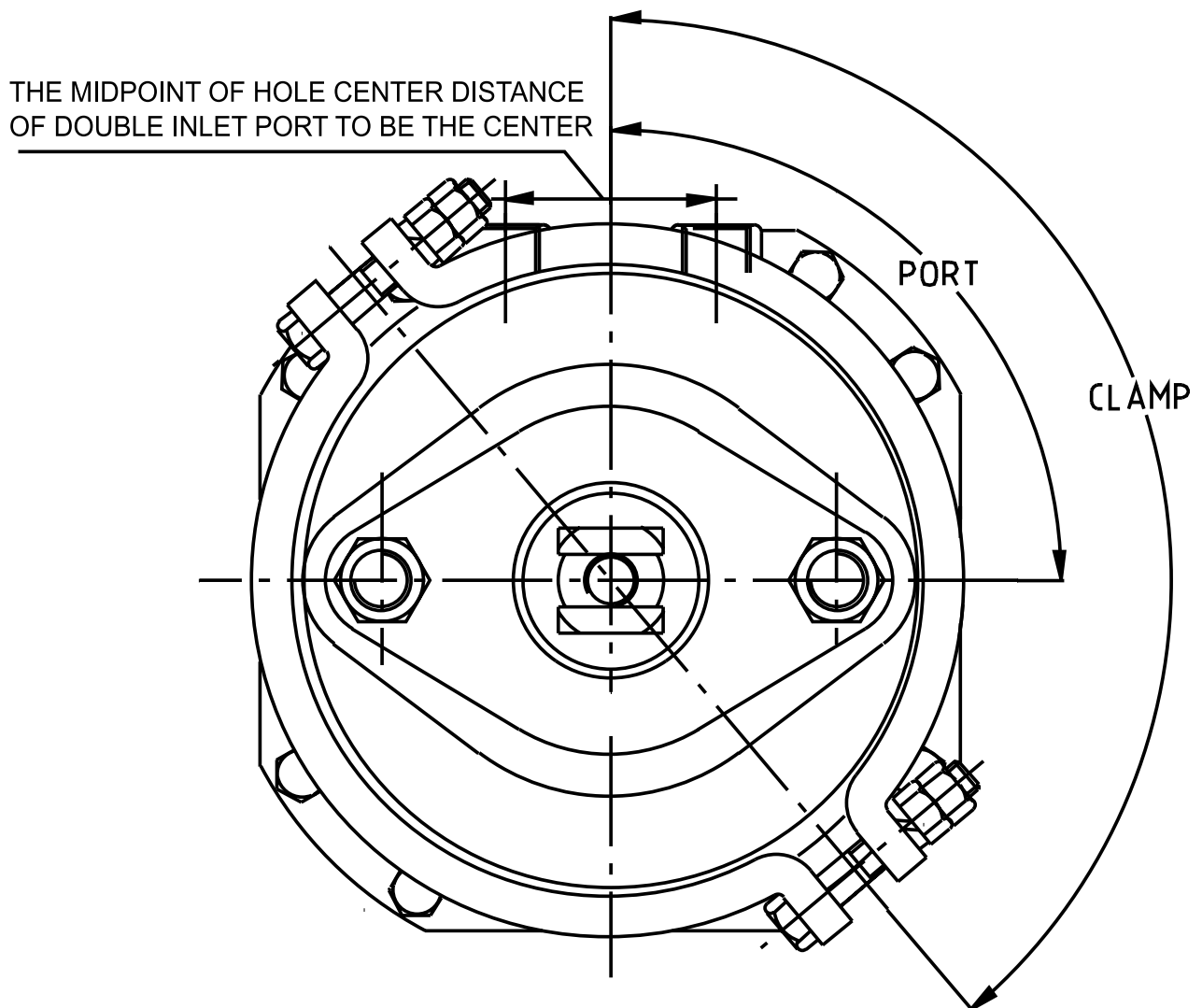



SORL	Type	Stroke	Port Thread	Push Rod Length	Port / Clamp Angle	Cross	Application
RL3530QB6	16/16	55/55mm	2xM16x1.5	15mm	90° / 45°	Alternative BS9397	BPW Trailer Axle Daimler 2222 IKARUS E99/E13/E91 Schmitz 051223



SORL	Type	Stroke	Port Thread	Push Rod Length	Port / Clamp Angle	Cross	Application
RL3530PE77	20/24	60/60mm	2xM16x1.5	15mm	90° / 45°	Alternative BS9404	DAF, Leyland
RL3530PP02	20/24	63/62mm	2xM16x1.5	15mm	0° / 0°	BS9485	DAF, Leyland
RL3530PP03	20/24	57/57mm	2xM16x1.5	15mm	90° / 135°	BS9404	BPW 0203275600 Schmitz 52509



SORL	Type	Stroke	Port Thread	Push Rod Length	Port / Clamp Angle	Cross	Application
RL3530PP04	20/24	51/51mm	2xM16x1.5		45°	Alternative BY9401	Iveco 8169241



SORL	Type	Stroke	Port Thread	Push Rod Length	Port / Clamp Angle	Cross	Application
RL3530CB01	24/24	63/62mm	2xM16x1.5	15mm	90° / 55°	QT469S4 Alternative BS8508	Foden
RL3530CB02	24/24	63/57mm	2xM16x1.5	15mm	170° / 125°	QT469S4 Alternative BS8508	Foden
RL3530CB04	24/24	63/62mm	2xM22x1.5 Voss	15mm	10° / 235°	Alternative BS9520	Mercedes Neoplan
RL3530CB06	24/24	57/57mm	2xM16x1.5	15mm	90° / 135°	BS9503	BPW 0203275600
RL3530CB07	24/24	57/57mm	2xM22x1.5 Voss	15mm	0° / 180°	BS9520	Mercedes 0501316050 Neoplan 11014306



SORL	Type	Stroke	Port Thread	Push Rod Length	Port / Clamp Angle	Cross	Application
RL3530CB24	24/24	57/57mm	2xM16x1.5	47mm	0° / 55°		DAF, Bus



SORL	Type	Stroke	Port Thread	Push Rod Length	Port / Clamp Angle	Cross	Application
RL3530MS01	24/30	57/57mm	2xM16x1.5	15mm	90° / 45°	BS8500	Scania 1427480 1734996



SORL	Type	Stroke	Port Thread	Push Rod Length	Port / Clamp Angle	Cross	Application
RL3530YY1	12/16	57/57mm	2xM22x1.5 Voss	15mm	90° / 300°	9254261000	DAF 1505436 MAN 81504106642 RVI 5010422315
RL3530YY2	12/16	57/57mm	2xM22x1.5 Voss	15mm	90° / 60°	9254261010	MAN 81504106642 RVI 5010422316



SORL	Type	Stroke	Port Thread	Push Rod Length	Port / Clamp Angle	Cross	Application
RL3530SY1	12/24	57/57mm	2xM22x1.5 Voss	15mm	58° / 148°	9254860100	DAF 1506228 Mercedes 0174209518
RL3530SY2	12/24	57/57mm	2xM22x1.5 Voss	15mm	122° / 212°	9254860110	DAF 1506272 Mercedes 0174209618



SORL	Type	Stroke	Port Thread	Push Rod Length	Port / Clamp Angle	Cross	Application
RL3530YZ1	14/16	57/57mm	2xM22x1.5 Voss	15mm	90° / 300°	9254262000	DAF 1505437 MAN 81504106575
RL3530YZ2	14/16	57/57mm	2xM22x1.5 Voss	15mm	90° / 60°	9254262010	DAF 1523676 MAN 81504106576



SORL	Type	Stroke	Port Thread	Push Rod Length	Port / Clamp Angle	Cross	Application
RL3530YZ4	16/16	57/57mm	2xM22x1.5 Voss	15mm	90° / 300°	9254248000	DAF 1505435 MAN 81504106581
RL3530YZ5	16/16	57/57mm	2xM22x1.5 Voss	15mm	90° / 60°	9254248010	DAF 1518154 MAN 81504106582
RL3530YZ12	16/16	57/57mm	2xM22x1.5 Voss	15mm	90° / 300°		



SORL	Type	Stroke	Port Thread	Push Rod Length	Port / Clamp Angle	Cross	Application
RL3530YZ9	16/16	57/57mm	2xM22x1.5 Voss	15mm	0° / 90°	9254644520	DAF 1506403



SORL	Type	Stroke	Port Thread	Push Rod Length	Port / Clamp Angle	Cross	Application
RL3530YT13	16/20	57/57mm	2xNPT1/4	15mm	90° / 0°		
RL3530YT14	16/20	57/57mm	2xNPT1/4	15mm	90° / 0°		



SORL	Type	Stroke	Port Thread	Push Rod Length	Port / Clamp Angle	Cross	Application
RL3530YX1	14/24	57/57mm	2xM22x1.5 Voss	15mm	0° / 225°	9254680100	Mercedes 0154205518
RL3530YX2	14/24	57/57mm	2xM22x1.5 Voss	15mm	58° / 148°	9254680120	Mercedes 0154205718
RL3530YX3	14/24	57/57mm	2xM22x1.5 Voss	15mm	122° / 212°	9254680130	Mercedes 0154205818
RL3530YX4	14/24	57/57mm	2xM22x1.5 Voss	15mm	27° / 117°	9254680200	Mercedes 0154205918
RL3530YX5	14/24	57/57mm	2xM22x1.5 Voss	15mm	153° / 243°	9254680210	Mercedes 0154206018
RL3530YX6	14/24	57/57mm	2xM22x1.5 Voss	15mm	125° / 125°	9254680220	Mercedes 0154204618
RL3530YX7	14/24	57/57mm	2xM22x1.5 Voss	15mm	55° / 235°	9254680230	Mercedes 0154204718
RL3530YX8	14/24	57/57mm	2xM22x1.5 Voss	15mm	58° / 148°	9254880140	Mercedes 0194205118
RL3530YX9	14/24	57/57mm	2xM22x1.5 Voss	15mm	122° / 212°	9254880150	Mercedes 0194205018
RL3530YX10	14/24	57/57mm	2xM22x1.5 Voss	15mm	0° / 225°	9254880100	DAF 1517296 Mercedes 0204207518



SORL	Type	Stroke	Port Thread	Push Rod Length	Port / Clamp Angle	Cross	Application
RL3530RY1	16/24	57/57mm	2xM22x1.5 Voss	15mm	153° / 243°	9254840210	Mercedes 0154206218
RL3530RY2	16/24	57/57mm	2xM22x1.5 Voss	15mm	27° / 117°	9254840200	Mercedes 0154206318
RL3530RY3	16/24	57/57mm	2xM22x1.5 Voss	15mm	58° / 148°	9254840220	Mercedes 0214206518
RL3530RY4	16/24	57/57mm	2xM22x1.5 Voss	15mm	122° / 212°	9254840230	Mercedes 0214206618
RL3530RY5	16/24	57/57mm	2xM22x1.5 Voss	15mm	58° / 148°	9254840260	Mercedes 02154207518
RL3530RY6	16/24	57/57mm	2xM22x1.5 Voss	15mm	122° / 212°	9254840270	Mercedes 0214207618
RL3530RY7	16/24	57/57mm	2xM16x1.5	15mm	45° / 135°	9254645000	Mercedes 0184205318 Scania 1505448
RL3530RY8	16/24	57/57mm	2xM16x1.5	15mm	135° / 225°	9254645010	Mercedes 0184205218 DAF 1518162
RL3530RY10	16/24	57/57mm	2xM22x1.5 Voss	15mm	27° / 117°	Alternative 9254840100	
RL3530RY11	16/24	57/57mm	2xM22x1.5 Voss	15mm	153° / 243°	Alternative 9254840110	



SORL	Type	Stroke	Port Thread	Push Rod Length	Port / Clamp Angle	Cross	Application
RL3530PF22	20/24	64/64mm	2xM16x1.5	15mm	45° / 135°	Alternative 9254601000	DAF 1505440 Mercedes 0184205518
RL3530PE02	20/24	64/64mm	2xM16x1.5	15mm	135° / 215°	Alternative 9254601010	DAF 1519192 Mercedes 0184205618
RL3530PE04	20/24	64/64mm	2xM16x1.5	15mm	0° / 90°	Alternative 9254601020	BPW 0203275600 DAF 1506400
RL3530PE05	20/24	64/64mm	2xM16x1.5	15mm	90° / 180°	Alternative 9254601030	DAF,Mercedes
RL3530PE06	20/24	64/64mm	2xM16x1.5	15mm	90° / 180°	Alternative 9254601040	DAF,Mercedes
RL3530PE07	20/24	64/64mm	2xM16x1.5	15mm	0° / 30°	Alternative 9254601050	DAF,Mercedes
RL3530PE08	20/24	64/64mm	2xM16x1.5	15mm	45° / 225°	Alternative 9254601070	DAF,Mercedes
RL3530PE03	20/24	64/64mm	2xM16x1.5	15mm	135° / 135°	Alternative 9254601080	DAF,Mercedes
RL3530PE09	20/24	64/64mm	2xM16x1.5	15mm	0° / 270°	Alternative 9254601090	DAF,Mercedes



SORL	Type	Stroke	Port Thread	Push Rod Length	Port / Clamp Angle	Cross	Application
RL3530PE40	20/24	64/64	2xM16x1.5	15mm	0° / 225°	3530FS50-001	Dongfeng, Yutong
RL3530PE41	20/24	64/64	2xM16x1.5	15mm	0° / 135°	3530FS50-002	Dongfeng, Yutong
RL3530PE76	20/24	64/64	2xM16x1.5	15mm	0° / 180°	55000100	XuZhou Meritor



SORL	Type	Stroke	Port Thread	Push Rod Length	Port / Clamp Angle	Cross	Application
RL3530PE72	20/24	65/65mm	2xM16x1.5	15mm	0° / 225°		



SORL	Type	Stroke	Port Thread	Push Rod Length	Port / Clamp Angle	Cross	Application
RL3530PE73	20/24	57/55mm	2xM22x1.5 Voss	15mm	27° / 117°	Alternative 9254800100	Mercedes 0154207518



SORL	Type	Stroke	Port Thread	Push Rod Length	Port / Clamp Angle	Cross	Application
RL3530YX11	24/16	65/45mm	2xM16x1.5	15mm	90° / 180°	9254612900	Scania 1516660



SORL	Type	Stroke	Port Thread	Push Rod Length	Port / Clamp Angle	Cross	Application
RL3530YX11A	24/16	65/45mm	2xM22x1.5	15mm	90° / 180°		



SORL	Type	Stroke	Port Thread	Push Rod Length	Port / Clamp Angle	Cross	Application
RL3530CA92	24/24	57/55mm	2xM22x1.5 Voss	15mm	27° / 117°	Alternative 9254610100	Mercedes Actros



SORL	Type	Stroke	Port Thread	Push Rod Length	Port / Clamp Angle	Cross	Application
RL3530CA35	24/24	57/55mm	2xM22x1.5 Voss	15mm	10° / 235°		Mercedes 015420918
RL3530CA36	24/24	57/55mm	2xM22x1.5 Voss	15mm	170° / 125°		Mercedes 0154209018
RL3530CA37	24/24	64/64mm	2xM16x1.5	15mm	90° / 60°		
RL3530CA45	24/24	64/64mm	2xM22x1.5	15mm	60° / 285°		
RL3530CA53	24/24	57/57mm	2xM22x1.5 Voss	15mm	27° / 117°		DAF 1519378 Mercedes 0154209318
RL3530CA54	24/24	57/57mm	2xM22x1.5 Voss	15mm	153° / 243°		Mercedes 0154209218
RL3530CA56	24/24	64/64mm	2xM16x1.5	15mm	0° / 270°	9254812000	Actros
RL3530CA57	24/24	64/64mm	2xM16x1.5	15mm	90° / 180°	9254812010	Actros



SORL	Type	Stroke	Port Thread	Push Rod Length	Port / Clamp Angle	Cross	Application
RL3530CA-X	24/24	64/64	2xM16x1.5	15mm	90° / 180°	3530010-XP100	Dongfeng
RL3530CA-Y	24/24	64/64	2xM16x1.5	15mm	90° / 180°	3530015-XP100	Dongfeng
RL3530CA-H	24/24	64/64	2xM16x1.5	15mm	90° / 45°	55000089	XuZhou Meritor



SORL	Type	Stroke	Port Thread	Push Rod Length	Port / Clamp Angle	Cross	Application
RL3530WA01	9/16	45/45mm	2xM16x1.5	83mm			Iveco



SORL	Type	Stroke	Port Thread	Push Rod Length	Port / Clamp Angle	Cross	Application
RL3530AK	30/24	58/58mm	2xM16x1.5	99mm	150° / 60°	K412-94300210	TBK
RL3530AK-A	30/24	58/58mm	2xM16x1.5	99mm	30° / 300°	K412-9440210	TBK



SORL	Type	Stroke	Port Thread	Push Rod Length	Port / Clamp Angle	Cross	Application
RL3530NZ1	12/12	50/50mm	M16x1.5 M14x1.5	76.5mm	160° / 160°	M250940	
RL3530NZ2	12/12	50/50mm	M16x1.5 M14x1.5	76.5mm	20° / 200°	M250950	
RL3530NZ3	12/12	53/53mm	M16x1.5 M14x1.5	72mm	90° / 180°		
RL3530NZ4	12/12	50/50mm	M16x1.5 M14x1.5	176.5mm	20° / 200°		
RL3530NZ5	12/12	50/50mm	M16x1.5 M12x1.5	76.5mm	160° / 160°		
RL3530NZ6	12/12	50/50mm	M16x1.5 M14x1.5	300mm	160° / 160°		
RL3530NZ7	12/12	50/50mm	M16x1.5 M14x1.5	250mm	160° / 160°		
RL3530NZ8	12/12	50/50mm	M16x1.5 M14x1.5	250mm	20° / 200°		
RL3530NZ9	12/12	50/50mm	M16x1.5 M14x1.5	270mm	160° / 160°		



SORL	Type	Stroke	Port Thread	Push Rod Length	Port / Clamp Angle	Cross	Application
RL3530QB1	16/16	54/54mm	2xNPT1/4	270mm	0° / 90°		
RL3530QB3	16/16	54/54mm	2xM16x1.5	270mm	0° / 90°		
RL3530QB8	16/16	55/54mm	2xNPT1/4	57mm (With Yoke)	0° / 135°	3519100LE030	JAC LCV III
RL3530QB9	16/16	55/54mm	2xNPT1/4	57mm (With Yoke)	0° / 45°	3519200LE030	JAC LCV III



SORL	Type	Stroke	Port Thread	Push Rod Length	Port / Clamp Angle	Cross	Application
RL3530QB44	16/16	54/54mm	2xNPT1/4	270mm	0° / 90°		
RL3530QB50	16/16	55/55mm	2xM16x1.5	270mm	0° / 90°		



SORL	Type	Stroke	Port Thread	Push Rod Length	Port / Clamp Angle	Cross	Application
RL3530RA16	16/24	57/57mm	2xM22x1.5 Voss	185mm	0° / 45°	9254241000	Mercedes 0124200018



SORL	Type	Stroke	Port Thread	Push Rod Length	Port / Clamp Angle	Cross	Application
RL3530RA1	16/24	50/50mm	2xM16x1.5	270mm	0° / 90°		
RL3530RA4	16/24	50/50mm	2xM16x1.5	300mm	0° / 90°		



SORL	Type	Stroke	Port Thread	Push Rod Length	Port / Clamp Angle	Cross	Application
RL3530RY9	16/24	57/57mm	2xM22x1.5 Voss	250mm	0° / 225°	9254941080	Universal



SORL	Type	Stroke	Port Thread	Push Rod Length	Port / Clamp Angle	Cross	Application
RL3530RA8	16/24	57/57mm	2xM16x1.5	187mm	0° / 45°		
RL3530RA22	16/24	50/50mm	2xM16x1.5	159mm	0° / 45°	9253240000	Mercedes 0064201118 0064203918



SORL	Type	Stroke	Port Thread	Push Rod Length	Port / Clamp Angle	Cross	Application
RL3530RA13	16/24	50/55mm	M14x1.5 M16x1.5	75mm	150° / 195°	M251850	
RL3530RA14	16/24	50/45mm	M14x1.5 M16x1.5	75mm	30° / 165°	M251840	



SORL	Type	Stroke	Port Thread	Push Rod Length	Port / Clamp Angle	Cross	Application
RL3530RA15	16/24	50/50mm	2xM16x1.5	270mm	0° / 90°		



SORL	Type	Stroke	Port Thread	Push Rod Length	Port / Clamp Angle	Cross	Application
RL3530PE	20/24	65/65mm	2xM16x1.5	276mm	0° / 225°	Alternative 9254300470	Scania



SORL	Type	Stroke	Port Thread	Push Rod Length	Port / Clamp Angle	Cross	Application
RL3530PE49	20/24	65/65mm	2xM16x1.5	243mm	0° / 225°		



SORL	Type	Stroke	Port Thread	Push Rod Length	Port / Clamp Angle	Cross	Application
RL3530PF18	20/24	60/60mm	2xM16x1.5	75mm	0° / 45°		



SORL	Type	Stroke	Port Thread	Push Rod Length	Port / Clamp Angle	Cross	Application
RL3530PF34	20/24	55/45mm	M14x1.5 M16x1.5	78mm	150° / 195°		



SORL	Type	Stroke	Port Thread	Push Rod Length	Port / Clamp Angle	Cross	Application
RL3530PF01	20/30	65/65mm	M22x1.5 M16x1.5	249.5mm	0° / 225°	9254500040	DAF 1518156



SORL	Type	Stroke	Port Thread	Push Rod Length	Port / Clamp Angle	Cross	Application
RL3530PF04	20/30	65/65mm	M22x1.5 M16x1.5	282.5mm	0° / 225°		



SORL	Type	Stroke	Port Thread	Push Rod Length	Port / Clamp Angle	Cross	Application
RL3530CA55	24/24	57/57mm	2xM22x1.5	190mm	0° / 225°	9254911420	DAF 1487296



SORL	Type	Stroke	Port Thread	Push Rod Length	Port / Clamp Angle	Cross	Application
RL3530CA60	24/24	65/65mm	2xM16x1.5	247mm	0° / 180°		



SORL	Type	Stroke	Port Thread	Push Rod Length	Port / Clamp Angle	Cross	Application
RL3530CA80	24/24	65/65mm	2xM16x1.5	247mm	0° / 180°	9254310950	Volvo 1606835 20566204



SORL	Type	Stroke	Port Thread	Push Rod Length	Port / Clamp Angle	Cross	Application
RL3530CA1	24/24	57/57mm	2xM16x1.5	270mm	0° / 90°	8845027500	
RL3530CA3	24/24	57/57mm	2xM16x1.5	300mm	0° / 90°		
RL3530CA16	24/24	57/57mm	2xM16x1.5	235mm	0° / 90°		
RL3530CA26	24/24	57/57mm	2xM16x1.5	270mm	0° / 90°		
RL3530CA39	24/24	57/57mm	2xM16x1.5	220mm	0° / 90°		



SORL	Type	Stroke	Port Thread	Push Rod Length	Port / Clamp Angle	Cross	Application
RL3530CA11	24/24	57/57mm	2xM16x1.5	270mm	0° / 90°		
RL3530CA19	24/24	57/57mm	2xM16x1.5	187mm	0° / 45°		
RL3530CA25	24/24	57/57mm	2xM16x1.5	270mm	0° / 135°		
RL3530CA52	24/24	57/57mm	2xM16x1.5	270mm	0° / 135°		



SORL	Type	Stroke	Port Thread	Push Rod Length	Port / Clamp Angle	Cross	Application
RL3530CA17	24/24	57/57mm	2xM22x1.5	290mm	0° / 45°	9253212020	Mercedes 0064206818
RL3530CA20	24/24	57/57mm	2xM22x1.5	270mm	0° / 45°		



SORL	Type	Stroke	Port Thread	Push Rod Length	Port / Clamp Angle	Cross	Application
RL3530CA27	24/24	57/57mm	2xM16x1.5	58mm	0° / 45°		



SORL	Type	Stroke	Port Thread	Push Rod Length	Port / Clamp Angle	Cross	Application
RL3530CA32	24/24	57/57mm	2xM18x1.5	277mm	0° / 90°		TVS



SORL	Type	Stroke	Port Thread	Push Rod Length	Port / Clamp Angle	Cross	Application
RL3530CA33	24/24	57/51mm	M14x1.5 M16x1.5	76mm	0° / 45°	M250780	
RL3530CA43	24/24	54/45mm	2xM22x1.5 Voss	76mm	0° / 45°		
RL3530CA44	24/24	57/51mm	2xM16x1.5	76mm	0° / 45°		



SORL	Type	Stroke	Port Thread	Push Rod Length	Port / Clamp Angle	Cross	Application
RL3530CA-A58	24/24	57/57mm	2xM16x1.5	187mm	0° / 225°	Alternative 9253211600	BPW 0203273900 DAF 1518145 Mercedes 0084206018



SORL	Type	Stroke	Port Thread	Push Rod Length	Port / Clamp Angle	Cross	Application
RL3530CA46	24/24	57/57mm	2xM16x1.5	270mm	0° / 90°		
RL3530CA47	24/24	54/54mm	2xM16x1.5	41mm	0° / 90°		
RL3530CA48	24/24	57/57mm	2xM16x1.5	270mm	0° / 90°		
RL3530CA49	24/24	57/57mm	2xM16x1.5	70mm	0° / 90°	925 431 003 0	Scania



SORL	Type	Stroke	Port Thread	Push Rod Length	Port / Clamp Angle	Cross	Application
RL3530CA93	24/24	57/57mm	2xM22x1.5	290mm	0° / 225°	9253212020	DAF 1518146 Mercedes 0064206818



SORL	Type	Stroke	Port Thread	Push Rod Length	Port / Clamp Angle	Cross	Application
RL3530CA83	24/24	57/57mm	2xM16x1.5	242mm	0° / 135°	WG9100360303	CNHTC Howo



SORL	Type	Stroke	Port Thread	Push Rod Length	Port / Clamp Angle	Cross	Application
RL3530MB	24/24	45/45mm	NPT1/4	115mm	0° / 15°		



SORL	Type	Stroke	Port Thread	Push Rod Length	Port / Clamp Angle	Cross	Application
RL3530MB2	24/24	45/45mm	NPT1/4	120mm	0° / 0°		



SORL	Type	Stroke	Port Thread	Push Rod Length	Port / Clamp Angle	Cross	Application
RL3530VA	24/30	65/60mm	2xM16x1.5	276mm	0° / 225°		



SORL	Type	Stroke	Port Thread	Push Rod Length	Port / Clamp Angle	Cross	Application
RL3530MA-B	24/30	45/45mm	2xNPT3/8	400mm	90° / 45°		



SORL	Type	Stroke	Port Thread	Push Rod Length	Port / Clamp Angle	Cross	Application
RL3530DZ1	27/24	64/64mm	2xM16x1.5	270mm	0° / 40°	1425324000001	Foton Auman Dump
RL3530DZ2	27/24	64/64mm	2xM16x1.5	270mm	0° / 150°	1425324000011	Foton Auman Dump



SORL	Type	Stroke	Port Thread	Push Rod Length	Port / Clamp Angle	Cross	Application
RL3530AA1	30/24	64/64mm	2xM16x1.5	270mm	0° / 90°	8845027550	Universal
RL3530AA20	30/24	64/64mm	2xNPT3/8	270mm	0° / 90°		



SORL	Type	Stroke	Port Thread	Push Rod Length	Port / Clamp Angle	Cross	Application
RL3530AA15	30/24	64/64mm	2xM16x1.5	270mm	0° / 90°		
RL3530AA18	30/24	64/64mm	2xM16x1.5	326mm	0° / 90°		



SORL	Type	Stroke	Port Thread	Push Rod Length	Port / Clamp Angle	Cross	Application
RL3530AA5	30/24	57/57mm	2xM16x1.5	270mm	0° / 90°		



SORL	Type	Stroke	Port Thread	Push Rod Length	Port / Clamp Angle	Cross	Application
RL3530AB-BL	30/24	64/64mm	2xM16x1.5	60mm	40° / 135°		XIANG FANG BUS
RL3530AB-BR	30/24	64/64mm	2xM16x1.5	60mm	140° / 45°		XIANG FANG BUS



SORL	Type	Stroke	Port Thread	Push Rod Length	Port / Clamp Angle	Cross	Application
RL3530MA	30/24	45/45mm	2xNPT3/8	400mm			ZM440, Hino
RL3530MA1	30/24	45/45mm	2xNPT3/8	370mm			
RL3530MA2	30/24	45/45mm	2xM16x1.5	370mm			



SORL	Type	Stroke	Port Thread	Push Rod Length	Port / Clamp Angle	Cross	Application
RL3530MA01	30/24		4xM16x1.5	400mm			HINO ZH440



SORL	Type	Stroke	Port Thread	Push Rod Length	Port / Clamp Angle	Cross	Application
RL3530MA7	30/24	45/45mm	2xNPT1/4	120mm			
RL3530MA8	30/24	45/45mm	2xNPT3/8	120mm			



SORL	Type	Stroke	Port Thread	Push Rod Length	Port / Clamp Angle	Cross	Application
RL3530SB19	30/30	60/60mm	2xM16x1.5	250mm	90° / 270°	Alternative 9254921020	F2100-F3600 RVI,DAF



SORL	Type	Stroke	Port Thread	Push Rod Length	Port / Clamp Angle	Cross	Application
RL3530SA1	30/30	64/64mm	2xM16x1.5	270mm	0° / 90°		Scania 1372917
RL3530SA3	30/30	64/64mm	2xM16x1.5	270mm	0° / 90°		



SORL	Type	Stroke	Port Thread	Push Rod Length	Port / Clamp Angle	Cross	Application
RL3530SA5	30/30	64/64mm	2xM16x1.5	270mm	0° / 90°	9254220700	Volvo 8129507



SORL	Type	Stroke	Port Thread	Push Rod Length	Port / Clamp Angle	Cross	Application
RL3530SB1	30/30	64/64mm	2xM16x1.5	250mm	0° / 90°	9253224240	Volvo 1605860 5003084
RL3530SB6	30/30	64/64mm	2xM16x1.5	250mm	0° / 90°		
RL3530SB11	30/30	64/64mm	2xM16x1.5	270mm	0° / 225°	Alternative 9253221550	DAF 1518149 RVI 5000716330
RL3530SB13	30/30	64/64mm	2xM16x1.5	105mm	45° / 315°	57RS3006140	BMC
RL3530SB14	30/30	64/64mm	2xM16x1.5	105mm	135° / 45°	57RS3006141	BMC



SORL	Type	Stroke	Port Thread	Push Rod Length	Port / Clamp Angle	Cross	Application
RL3530SB5	30/30	64/64mm	2xM16x1.5	270mm	0° / 90°		
RL3530SB9	30/30	64/64mm	2xM16x1.5	270mm	0° / 90°		



SORL	Type	Stroke	Port Thread	Push Rod Length	Port / Clamp Angle	Cross	Application
RL3530SB12	30/30	64/64mm	2xM16x1.5	45mm	30° / 120°	9253224230	DAF 1518150 Mercedes 0074202918



SORL	Type	Stroke	Port Thread	Push Rod Length	Port / Clamp Angle	Cross	Application
RL3530SB4	30/30	64/64mm	2xM16x1.5	95mm	0° / 90°	1122924080002	Foton Auman



SORL	Type	Stroke	Port Thread	Push Rod Length	Port / Clamp Angle	Cross	Application
RL3530SB10	30/30	64/64mm	2xM16x1.5	270mm	0° / 90°		



SORL	Type	Stroke	Port Thread	Push Rod Length	Port / Clamp Angle	Cross	Application
RL3530SE-CL	30/30	70/70mm	2xM16x1.5	55mm	40° / 140°	3530ZS07Y-001	Dongfeng
RL3530SE-CR	30/30	70/70mm	2xM16x1.5	55mm	140° / 40°	3530ZS07Y-002	Dongfeng



SORL	Type	Stroke	Port Thread	Push Rod Length	Port / Clamp Angle	Cross	Application
RL3530ZZ01	36/30	70/70mm	2xM16x1.5	93mm	0° / 0°	5K91730	BMC



Size	With SORL Logo	Without SORL Logo	L	φA	φB	Size	With SORL Logo	Without SORL Logo	L	φA	φB
T9	/	3530 000 013 2	36	134	92.5	T20	3530 000 020 2	3530 000 037 2	45	167	120
T12	3530 630 002 2	/	31	140	105	T24	3530 000 031 2	3530 000 038 2	45	180	140
T16	3530 000 027 2	3530 000 042 2	36	160	99	T24	3530 000 034 2	/	48.5	178	125.7
T16	3530 000 024 2	3530 000 035 2	45.5	160	117.5	T24	3519 820 001 2	/	49	179	128
T16	3519 810 001 2	/	47.5	160	109.5	T24	3530 000 023 2	3530 000 039 2	38	180	126
T16	3530 000 022 2	/	36	154	114	T30	3530 000 021 2	3530 000 040 2	39	201	143
T20	3530 000 025 2	3530 000 036 2	36	167	115	T30	3530 000 029 2	3530 000 041 2	52.5	201	152



SORL	Type	Stroke	Port Thread	Push Rod Length	Port / Clamp Angle	Cross	Application
RL3530RB7	16/24	57/57	M16x1.5	15mm	90° / 45°	1351624004	BPW 0544440010 0544440010



SORL	Type	Stroke	Port Thread	Push Rod Length	Port / Clamp Angle	Cross	Application
RL3530RB8	16/24	57/57	2xM16x1.5	15mm	120° / 75°	03.130.00.40	Mercedes
RL3530RB9A	16/24	57/57	2xM16x1.5	15mm	60° / 285°	03.130.00.41	Mercedes
RL3530RB10A	16/24	57/57	2xM16x1.5	15mm	90° / 45°	03.130.00.01	Mercedes
RL3530RB11	16/24	57/57	2xM16x1.5	15mm	90° / 180°	03.130.00.56	Mercedes



SORL	Type	Stroke	Port Thread	Push Rod Length	Port / Clamp Angle	Cross	Application
RL3530RB12	16/24	57/57	2xM16x1.5	15mm	120° / 75°	38162415	



SORL	Type	Stroke	Port Thread	Push Rod Length	Port / Clamp Angle	Cross	Application
RL3530RB2	16/24	60/50	2xM16x1.5	90mm	90° / 90°		



SORL	Type	Stroke	Port Thread	Push Rod Length	Port / Clamp Angle	Cross	Application
RL3530RB4	16/24	60/50	2xM16x1.5	73mm	90° / 90°		



SORL	Type	Stroke	Port Thread	Push Rod Length	Port / Clamp Angle	Cross	Application
RL3530NA	20/24	64/64	M16x1.5	375mm	90° / 45°		



SORL	Type	Stroke	Port Thread	Push Rod Length	Port / Clamp Angle	Cross	Application
RL3530NA42	20/24	64/64	M16x1.5	375mm	90° / 45°		



SORL	Type	Stroke	Port Thread	Push Rod Length	Port / Clamp Angle	Cross	Application
RL3530NA-C	20/24	64/64	2xNPT3/8	103mm	0° / 0°		



SORL	Type	Stroke	Port Thread	Push Rod Length	Port / Clamp Angle	Cross	Application
RL3530HA1	24/24	64/64	2xNPT3/8	270mm	0° / 90°		
RL3530HA5	24/24	64/64	2xM16x1.5	270mm	0° / 90°		
RL3530HA6	24/24	64/64	2xNPT3/8	270mm	0° / 90°		
RL3530HA12	24/24	57/57	2xNPT3/8	205mm	90° / 135°		



SORL	Type	Stroke	Port Thread	Push Rod Length	Port / Clamp Angle	Cross	Application
RL3530HA3	24/24	57/57	2xNPT3/8	270mm	90° / 90°		



SORL	Type	Stroke	Port Thread	Push Rod Length	Port / Clamp Angle	Cross	Application
RL3530HA7	24/24	57/57	2xNPT3/8	270mm	90° / 90°		



SORL	Type	Stroke	Port Thread	Push Rod Length	Port / Clamp Angle	Cross	Application
RL3530HA8	24/24	57/57	2xM16x1.5	270mm	0° / 90°		
RL3530HA9	24/24	57/57	2xNPT3/8	207mm	0° / 90°		



SORL	Type	Stroke	Port Thread	Push Rod Length	Port / Clamp Angle	Cross	Application
RL3530HA14	24/24	57/57	2xNPT3/8	310mm	90° / 45°		



SORL	Type	Stroke	Port Thread	Push Rod Length	Port / Clamp Angle	Cross	Application
RL3530EA1	24/30	57/57	2xNPT3/8	270mm	0° / 90°	264764	
RL3530EA5	24/30	57/57	2xNPT3/8	270mm	0° / 90°		
RL3530EA7	24/30	57/57	2xNPT3/8	270mm	90° / 90°		
RL3530EA11	24/30	57/57	2xM16x1.5	270mm	0° / 90°	264763	



SORL	Type	Stroke	Port Thread	Push Rod Length	Port / Clamp Angle	Cross	Application
RL3530EA2	24/30	57/57	2xNPT3/8	270mm	0° / 90°		
RL3530EA3	24/30	57/57	2xM16x1.5	270mm	0° / 90°		
RL3530EA4	24/30	57/57	2xNPT3/8	200mm	0° / 135°		
RL3530EA17	24/30	57/57	2xM16x1.5	270mm	0° / 90°		
RL3530EA23	24/30	64/64	2xNPT3/8	180mm	0° / 135°		



SORL	Type	Stroke	Port Thread	Push Rod Length	Port / Clamp Angle	Cross	Application
RL3530EA13	24/30	57/57	2xM16x1.5	270mm	90° / 90°		
RL3530EA15	24/30	57/57	2xM16x1.5	270mm	90° / 90°		
RL3530EA18	24/30	57/57	2xNPT3/8	270mm	90° / 90°		
RL3530EA21	24/30	57/57	2xNPT3/8	270mm	90° / 90°		
RL3530EA25	24/30	57/57	2xNPT3/8	270mm	90° / 135°		



SORL	Type	Stroke	Port Thread	Push Rod Length	Port / Clamp Angle	Cross	Application
RL3530EA22	24/30	57/57	2xM16x1.5	270mm	90° / 90°		
RL3530EA26	24/30	57/57	2xNPT3/8	310mm	90° / 45°		
RL3530EA27	24/30	57/57	2xM16x1.5	270mm	0° / 90°		
RL3530EA28	24/30	64/64	2xNPT3/8	192mm	0° / 135°		



SORL	Type	Stroke	Port Thread	Push Rod Length	Port / Clamp Angle	Cross	Application
RL3530EA29	24/30	57/57	2xNPT3/8	270mm	90° / 135°		



SORL	Type	Stroke	Port Thread	Push Rod Length	Port / Clamp Angle	Cross	Application
RL3530EA30	24/30	57/57	2xNPT3/8	330mm	90° / 135°	179.SB2430S	American truck



Case Qty(pcs):2

SORL	Type	Stroke	Port Thread	Push Rod Length	Port / Clamp Angle	Cross	Application
RL3530EA33	24/30	64/64	2xNPT3/8	270mm	90° / 135°		



Case Qty(pcs):2

SORL	Type	Stroke	Port Thread	Push Rod Length	Port / Clamp Angle	Cross	Application
RL3530EA34	24/30	64/64	2xNPT3/8	270mm	90° / 135°		



SORL	Type	Stroke	Port Thread	Push Rod Length	Port / Clamp Angle	Cross	Application
RL3530EA35	24/30	57/57	2xNPT3/8	216mm	0° / 90°		



SORL	Type	Stroke	Port Thread	Push Rod Length	Port / Clamp Angle	Cross	Application
RL3530EY2	24/30	75/75	2xNPT3/8	254mm	0° / 90°		
RL3530EY3	24/30	75/75	2xM16x1.5	254mm	0° / 90°		



SORL	Type	Stroke	Port Thread	Push Rod Length	Port / Clamp Angle	Cross	Application
RL3530EY6	24/30	75/75	2xM16x1.5	254mm	0° / 90°		



SORL	Type	Stroke	Port Thread	Push Rod Length	Port / Clamp Angle	Cross	Application
RL3530EY8	24/30	70/70	2xNPT3/8	225mm	0° / 135°		
RL3530EY9	24/30	70/65	2xNPT3/8	225mm	90° / 135°		



SORL	Type	Stroke	Port Thread	Push Rod Length	Port / Clamp Angle	Cross	Application
RL3530EY10	24/30	75/75	2xM16x1.5	340mm	90° / 90°		



SORL	Type	Stroke	Port Thread	Push Rod Length	Port / Clamp Angle	Cross	Application
RL3530EY11	24/30	70/70	2xM16x1.5	254mm	90° / 45°		



SORL	Type	Stroke	Port Thread	Push Rod Length	Port / Clamp Angle	Cross	Application
RL3530EY12	24/30	70/70	2xM16x1.5	210mm	90° / 135°		



SORL	Type	Stroke	Port Thread	Push Rod Length	Port / Clamp Angle	Cross	Application
RL3530EY13	24/30	70/65	2xNPT3/8	225mm	0° / 135°		



SORL	Type	Stroke	Port Thread	Push Rod Length	Port / Clamp Angle	Cross	Application
RL3530EY14	24/30	75/75	2xM16x1.5	241mm	90° / 45°	2430GCMEXLS	



SORL	Type	Stroke	Port Thread	Push Rod Length	Port / Clamp Angle	Cross	Application
RL3530EY15	24/30	75/75	2xM16x1.5	186mm	90° / 45°	9253713000	DAF 1325352



SORL	Type	Stroke	Port Thread	Push Rod Length	Port / Clamp Angle	Cross	Application
RL3530EY16	24/30	70/70	2xNPT3/8	180mm	0° / 135°		



SORL	Type	Stroke	Port Thread	Push Rod Length	Port / Clamp Angle	Cross	Application
RL3530EY17	24/30	70/65	2xNPT3/8	225mm	0° / 135°		



SORL	Type	Stroke	Port Thread	Push Rod Length	Port / Clamp Angle	Cross	Application
RL3530EY21	24/30	75/75	2xM16x1.5	246mm	90° / 135°	1362430001	DAF



SORL	Type	Stroke	Port Thread	Push Rod Length	Port / Clamp Angle	Cross	Application
RL3530GA	28/32	57/57	2xNPT1/4	217mm	90° / 0°		FAW



SORL	Type	Stroke	Port Thread	Push Rod Length	Port / Clamp Angle	Cross	Application
RL3530BA1	30/30	60/60mm	2xNPT3/8	270mm	90° / 90°		
RL3530BA4	30/30	60/60mm	2xNPT3/8	320mm	90° / 45°		
RL3530BA10	30/30	60/60mm	2xNPT3/8	300mm	0° / 90°		



SORL	Type	Stroke	Port Thread	Push Rod Length	Port / Clamp Angle	Cross	Application
RL3530BA2	30/30	60/60mm	2xNPT3/8	270mm	90° / 90°		
RL3530BA11	30/30	60/60mm	2xNPT3/8	270mm	90° / 90°		



SORL	Type	Stroke	Port Thread	Push Rod Length	Port / Clamp Angle	Cross	Application
RL3530BA5	30/30	60/60mm	2xNPT3/8	200mm	0° / 135°		
RL3530BA12	30/30	60/60mm	2xNPT3/8	270mm	0° / 90°		



SORL	Type	Stroke	Port Thread	Push Rod Length	Port / Clamp Angle	Cross	Application
RL3530BA16	30/30	60/60mm	2xNPT3/8	270mm	90° / 135°		



SORL	Type	Stroke	Port Thread	Push Rod Length	Port / Clamp Angle	Cross	Application
RL3530BA17	30/30	60/60mm	2xNPT3/8	270mm	0° / 90°		
RL3530BA19	30/30	60/60mm	2xM16x1.5	270mm	0° / 90°		
RL3530BA29	30/30	60/60mm	2xNPT3/8	180mm	0° / 135°		



SORL	Type	Stroke	Port Thread	Push Rod Length	Port / Clamp Angle	Cross	Application
RL3530BA21	30/30	60/60mm	2xM16x1.5	270mm	90° / 135°		



SORL	Type	Stroke	Port Thread	Push Rod Length	Port / Clamp Angle	Cross	Application
RL3530BA23	30/30	60/60mm	2xNPT3/8	270mm	90° / 90°		
RL3530BA28	30/30	60/60mm	2xM16x1.5	270mm	90° / 90°		
RL3530BA30	30/30	60/60mm	2xNPT3/8	237mm	90° / 90°		
RL3530BA31	30/30	60/60mm	2xNPT3/8	47mm	90° / 90°		
RL3530BA32	30/30	60/60mm	2xNPT3/8	270mm	90° / 90°		



SORL	Type	Stroke	Port Thread	Push Rod Length	Port / Clamp Angle	Cross	Application
RL3530BA33	30/30	60/60mm	2xNPT3/8	270mm	90° / 135°		



SORL	Type	Stroke	Port Thread	Push Rod Length	Port / Clamp Angle	Cross	Application
RL3530BA40	30/30	64/64mm	2xNPT3/8	270mm	90° / 135°		



SORL	Type	Stroke	Port Thread	Push Rod Length	Port / Clamp Angle	Cross	Application
RL3530BA41	30/30	60/60mm	2xNPT3/8	310mm	90° / 45°		



SORL	Type	Stroke	Port Thread	Push Rod Length	Port / Clamp Angle	Cross	Application
RL3530BA42	30/30	60/60mm	2xM16x1.5	180mm	90° / 135°		



SORL	Type	Stroke	Port Thread	Push Rod Length	Port / Clamp Angle	Cross	Application
RL3530BA43	30/30	64/64mm	2xNPT3/8	235mm	90° / 90°		



SORL	Type	Stroke	Port Thread	Push Rod Length	Port / Clamp Angle	Cross	Application
RL3530BA44	30/30	64mm	2xNPT3/8		90°		



SORL	Type	Stroke	Port Thread	Push Rod Length	Port / Clamp Angle	Cross	Application
RL3530BA45	30/30	70/70mm	2xNPT3/8	210mm	90° / 135°		



SORL	Type	Stroke	Port Thread	Push Rod Length	Port / Clamp Angle	Cross	Application
RL3530BA46	30/30	64/64mm	2xM16x1.5	270mm	90° / 90°		



SORL	Type	Stroke	Port Thread	Push Rod Length	Port / Clamp Angle	Cross	Application
RL3530BA47	30/30	60/60mm	2xM16x1.5	270mm	0° / 90°		



SORL	Type	Stroke	Port Thread	Push Rod Length	Port / Clamp Angle	Cross	Application
RL3530BA53	30/30	60/60mm	2xNPT3/8	330mm	90° / 135°		



SORL	Type	Stroke	Port Thread	Push Rod Length	Port / Clamp Angle	Cross	Application
RL3530BA54	30/30	60/60mm	2xM16x1.5	95mm	90° / 90°	55000067	



SORL	Type	Stroke	Port Thread	Push Rod Length	Port / Clamp Angle	Cross	Application
RL3530BA56	30/30	60/60mm	2xNPT3/8	270mm	90° / 135°		



SORL	Type	Stroke	Port Thread	Push Rod Length	Port / Clamp Angle	Cross	Application
RL3530BA57	30/30	65/65mm	2xNPT3/8	185mm	90° / 45°		



SORL	Type	Stroke	Port Thread	Push Rod Length	Port / Clamp Angle	Cross	Application
RL3530BA66	30/30	64/64mm	2xNPT3/8	115mm	90° / 135°		



SORL	Type	Stroke	Port Thread	Push Rod Length	Port / Clamp Angle	Cross	Application
RL3530BA71	30/30	64/64mm	2xM16x1.5	270mm	90° / 90°		



SORL	Type	Stroke	Port Thread	Push Rod Length	Port / Clamp Angle	Cross	Application
RL3530BA75	30/30	64/64mm	2xNPT3/8	205mm	90° / 135°		



SORL	Type	Stroke	Port Thread	Push Rod Length	Port / Clamp Angle	Cross	Application
RL3530BA61	30/30	64/64mm	2xM16x1.5	65mm	0° / 135°	WG9000360108/1	CNHTC Howo



SORL	Type	Stroke	Port Thread	Push Rod Length	Port / Clamp Angle	Cross	Application
RL3530BT3	30/30	65/65mm	2xNPT3/8	300mm (Parking Brake Status)	90° / 45°		
RL3530BT4	30/30	65/65mm	2xNPT3/8	120mm (Parking Brake Status)	90° / 45°		

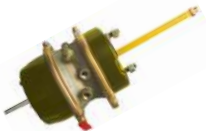

SORL	Type	Stroke	Port Thread	Push Rod Length	Port / Clamp Angle	Cross	Application
RL3530BT8	30/30	65/65mm	2xNPT3/8	120mm	90° / 45°		



SORL	Type	Stroke	Port Thread	Push Rod Length	Port / Clamp Angle	Cross	Application
RL3530BT-A	30/30	64/64mm	2xNPT3/8	205mm	90° / 135°		



SORL	Type	Stroke	Port Thread	Push Rod Length	Port / Clamp Angle	Cross	Application
RL3530BV-KL	30/30	64/64mm	2xNPT3/8	60mm	140° / 90°		XiaMen KingLong
RL3530BV-KR	30/30	64/64mm	2xNPT3/8	60mm	40° / 90°		XiaMen KingLong
RL3530BV-PL	30/30	64/64mm	2xNPT3/8	305mm	140° / 90°		XiaMen KingLong
RL3530BV-PR	30/30	64/64mm	2xNPT3/8	305mm	40° / 90°		XiaMen KingLong

Axle Devices		13
Control Arm Type		13.01
Manual Slack Adjuster		13.02
Automatic Slack Adjuster		13.03

Control Arm Type - II



Control Arm Type - I

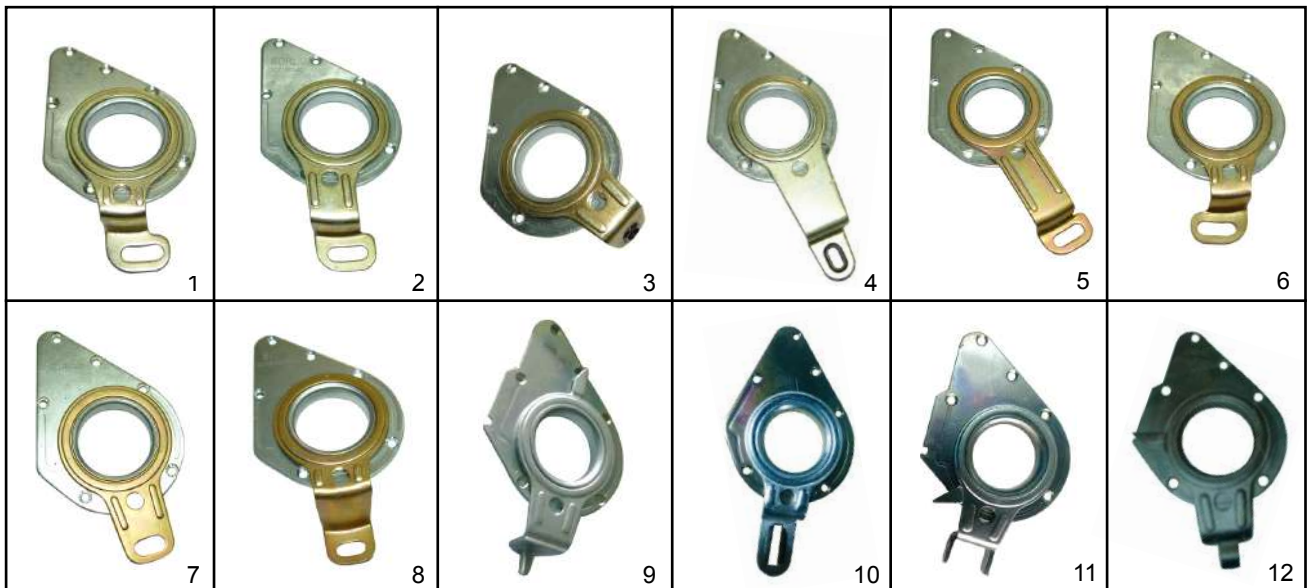

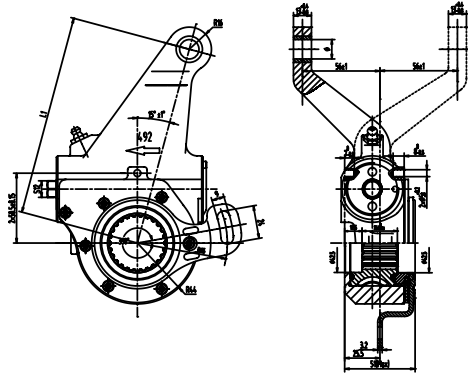

SORL	Cross	Cast	Control Arm No.	Spline Teeth	L1	Bush Dia	OEM Number	Applic.
493012631507	80000 80084 80176	5018	II-1	26	145	14	12336, 70760, 4731113, 4731766, 061742003383874200338, 4332067020 4332067060, 4335765030, 9454200238 A9454200238, KB2065, MER62043	DC MAN
492012631507	80001 80085 80177	5017	II-1	26	145	14	12335, 70761, 4731121, 4731774, 70115348 06174200438, 3874200238, 4332067030 4332067070, 4335765020, 9454200338 A9454200338, KB2060, MER62044, 0517490210	DC MAN
493012611507	80163	5018	II-1	26	145	14	9454201238	DC
492012611507	80164	5017	II-1	26	145	14	9454201338	DC

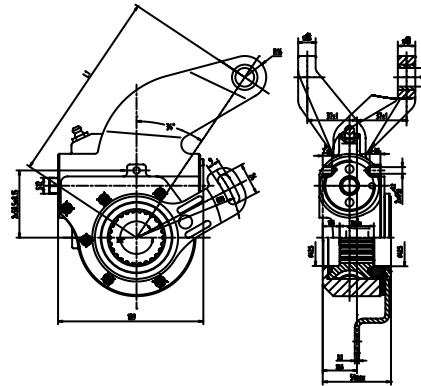

SORL	Cross	Cast	Control Arm No.	Spline Teeth	L1	Bush Dia	OEM Number	Applic.
494022631507	80008 80087 80178	5016	II-2	26	145	14	10643, 14717, 162200, 4731196, 4731295 4731329, 4731782, 06194200038, 4332067010 4332067050, 4332067090, 4335767100 4335767120, 4335767240, 9454200038 A9454200038, KB2165, KB2855	DC MAN
495022631507	80009 80088 80179	5015	II-2	26	145	14	10644, 14718, 1662201, 4731204, 4731303 4731337, 4731790, 06194200138, 4332067000 4332067040, 4332067080, 4335767110 4335767130, 4335767250, 9454200138 A9454200138, KB2145, 0517490200	DC MAN
494011031507	80039	5016	II-1	10	145	14		Kamaz
495011031507	80040	5015	II-1	10	145	14		Kamaz
494022611507	80165	5016	II-2	26	145	14	945 420 10 38	DC
495022611507	80166	5015	II-2	26	145	14	945 420 11 38	DC

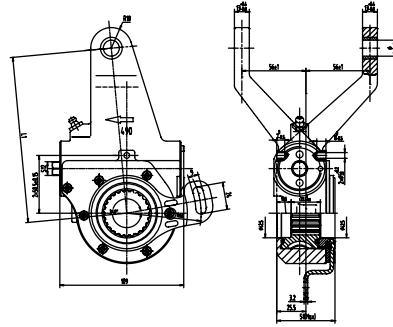

SORL	Cross	Cast	Control Arm No.	Spline Teeth	L1	Bush Dia	OEM Number	Applic.
491012631507	80010 80092 80180	5020	II-1	26	145	14	10509, 4731154, 4731808, 3834200538 9454200838, A9454200838, KB2140	DC MAN
490012631507	80011 80093 80181	5019	II-1	26	145	14	10508, 4731147, 4731816, 3834200438 9454200738, A9454200738, KB2135	DC MAN

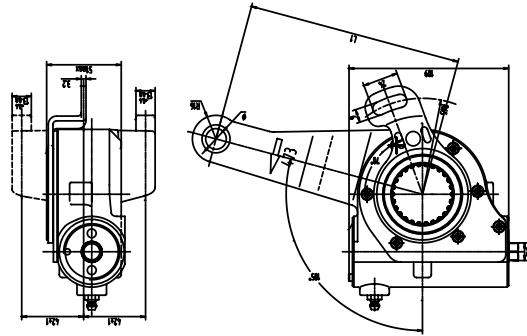

SORL	Cross	Cast	Control Arm No.	Spline Teeth	L1	Bush Dia	OEM Number	Applic.
474012630117	80012	5032	II-2	26	145	14	3854201738, 9454200538, A9454200538	DC
473012630117	80013	5033	II-2	26	145	14	3854201838, 9454200638, A9454200638	DC

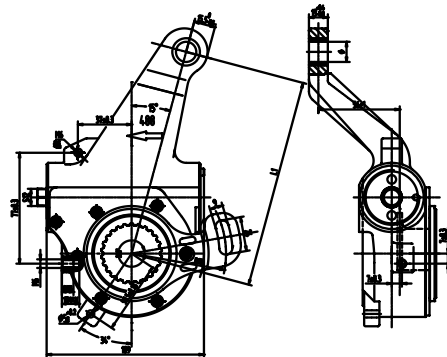

SORL	Cross	Cast	Control Arm No.	Spline Teeth	L1	Bush Dia	OEM Number	Applic.
488012630117	80014 KB6540	5031	II-2	26	145	14	9454200438, A9454200438	DC
488012630217	80183 KB6625 80086	2009	II-1	26	145	14	81506106258, 80086	MAN

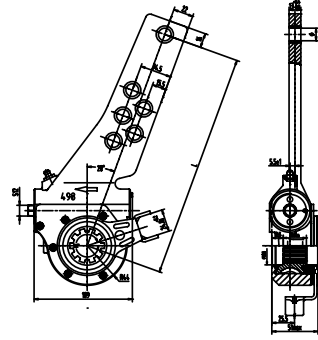

SORL	Cross	Cast	Control Arm No.	Spline Teeth	L1	Bush Dia	OEM Number	Applic.
498111030817	80018 80041	5027	II-11	10	180	14	4175026200	SAF
498111020117	80019	5027	II-11	10	250	14	14503, 008671, 0557482873, 0517482392, 0557482873	BPW
498111010217	80020	5027	II-11	10	205	14	14505, 4731840	ROR, Meritor
498113710317	80021	5027	II-11	37	215	14(L1:16)	KB1020D	Fruehauf
498111010417	80022	5027	II-11	10	250	14	14505, 4731840	SAF
498111010317	80023	5027	II-11	10	215	14(L1:16)	14507, KB1025D	Traile, SMB
498111010517	80024	5027	II-11	10	210	14	14545, KB1015D	Traile
498102831016	80025	5027	II-10	28	250	12		
498102811116	80031	5027	II-10	28	180	12		
498111010615	80032	5027	II-11	10	150	12.7		Go-Axles Henred, Fruehauf
498103731417	80033	5027	II-10	37	180	14		
498113710615	80037	5027	II-11	37	150	12.7		Go-Axles Henred, Fruehauf
498032030917	80042	5027	II-3	20	175	14		
498111010717	80067	5027	II-11	10	250	14		Trailer
498112630817	80078	5027	II-11	26	180	14		
498111021215	80082	5027	II-11	10	125	12.7		
498111011517	80108	5027	II-11	10	250	14		
498111011717	80126	5027	II-11	10	180	14	9319299	SAE
498111011317	80133	5027	II-11	10	127.5	14		DaeWoo
498061011617	80134	5027	II-6	10	180	14		SAE

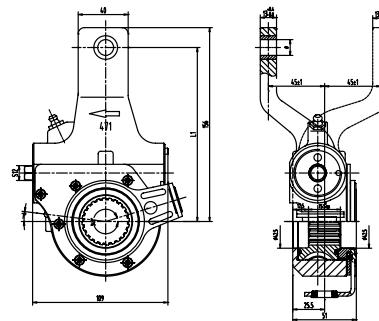

SORL	Cross	Cast	Control Arm No.	Spline Teeth	L1	Bush Dia	OEM Number	Applic.
472102410115	80070	5039	II-10	24	140	12.7		
471102410115	80071	5040	II-10	24	140	12.7		
472032410115	80106	5039	II-3	24	140	12.7		Telco
471032410115	80107	5040	II-3	24	140	12.7		Telco

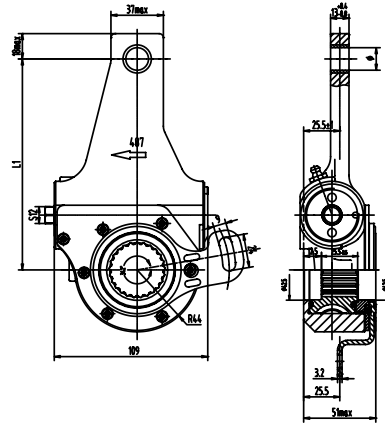

SORL	Cross	Cast	Control Arm No.	Spline Teeth	L1	Bush Dia	OEM Number	Applic.
487112830215	80034	475-20000	II-11	28	153	12.7		
487112830318	80035	475-20000	II-11	28	153	16		
487091030115	80045	475-20000	II-9	10	160	12.7		
487032530418	80061	475-20000	II-3	25	150	16		DaeWoo
487102410515	80069	475-20000	II-10	24	140	12.7		
487092410515	80072	475-20000	II-9	24	140	12.7		TATA
487092410505	80075	475-20000	II-9	24	140	12.7		TATA
487031030115	80089	475-20000	II-3	10	160	12.7		
487032830515	80094	475-20000	II-3	28	140	12.7		SAF
487012530418	80095	475-20000	II-1	25	150	16		
487031020515	80109	475-20000	II-3	10	140	12.7		South Africa
487032830517	80150	475-20000	II-3	28	140	14		DC

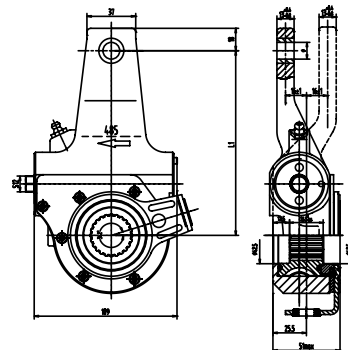

SORL	Cross	Cast	Control Arm No.	Spline Teeth	L1	Bush Dia	OEM Number	Applic.
486092410115	80073	5037	II-9	24	140	12.7		
485092410115	80074	5038	II-9	24	140	12.7		
486032410115	80076	5037	II-9	24	140	12.7		
485032410115	80077	5038	II-3	24	140	12.7		

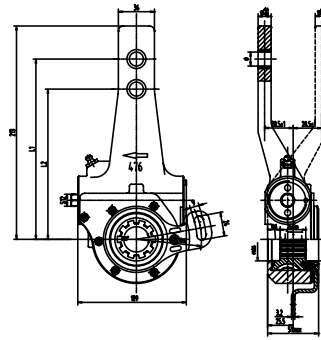

SORL	Cross	Cast	Control Arm No.	Spline Teeth	L1	Bush Dia	OEM Number	Applic.
476011010117	80124	5047	II-1	10	150 180	14		SAE
477011010117	80125	5046	II-1	10	180 150	14		SAE
476011010217	80129	5047	II-1	10	165	14		SAE
477011010217	80130	5046	II-1	10	165	14		SAE

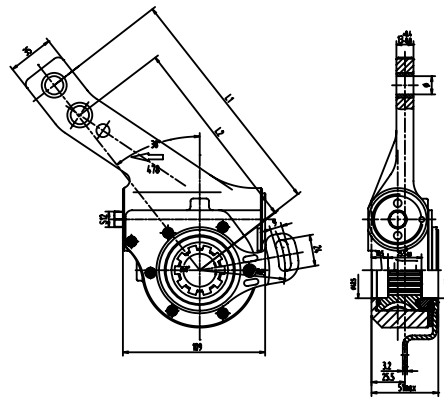

SORL	Cross	Cast	Control Arm No.	Spline Teeth	L1	Bush Dia	OEM Number	Applic.
478011010117	80136	5041	II-1	10	150 180	14		SAE

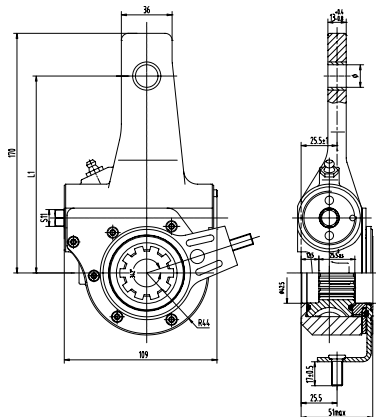

SORL	Cross	Cast	Control Arm No.	Spline Teeth	L1	Bush Dia	Applic.
475102430217	80200	2003	II-10	24	125	Φ14	Isuzu
475091030118	40920044	2003	II-9	28	139.7	Φ16	

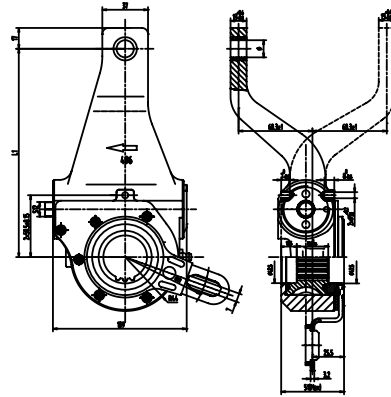

SORL	Cross	Cast	Control Arm No.	Spline Teeth	L1	Bush Dia	OEM Number	Applic.
497102511507	80300	2008	11-10	25	170	14		HMC
496102511507	80301	2009	11-10	25	170	14		HMC
497102531507	80348	2008	11-10	25	170	14		
496102531507	80349	2009	11-10	25	170	14		

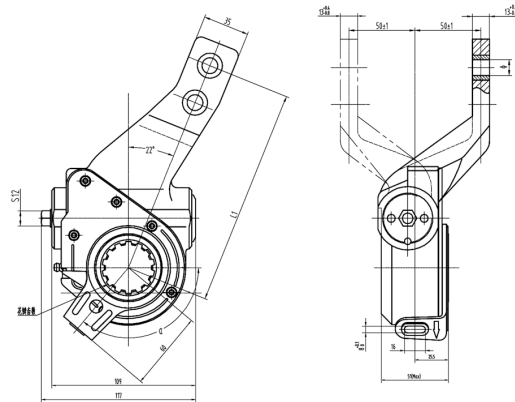

SORL	Cross	Cast	Control Arm No.	Spline Teeth	L1	L2	Bush Dia	Applic.
351011040848	72825	4040	1	10	165		Φ16	Scania
	72630							
351011030848	72488	4040	1	10	165		Φ16	Scania
351011030808	72247	4040	1	10	165		Φ16	Scania
351061931427	72929	4040	6	19	152		Φ14	ZF
	79462							
351012831408	79154	4040	1	28	165		Φ16	
351031421306	79351	4040	3	14	165	135	Φ12	
352011040848	72826	4041	1	10	165		Φ16	Scania
	72631							
352011030848	72489							
352011030808	72248	4041	1	10	165		Φ16	Scania
352012830408	79155	4041	1	28	165		Φ16	
352031421306	79352	4041	3	14	165	135	Φ12	

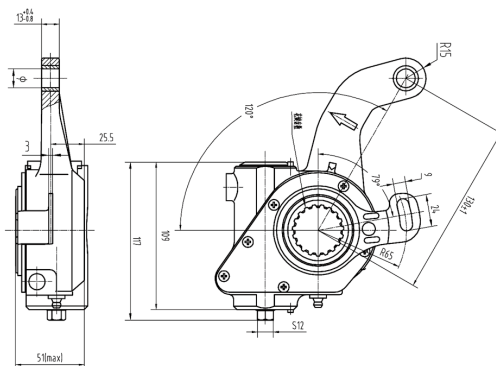

SORL	Cross	Cast	Control Arm No.	Spline Teeth	L1	Bush Dia	Applic.
177012630797	70775	3202	1	26	130	Φ14	DC
177011930797	70157	3202	1	19	130	Φ14	Neoplan
	72177						
	72518						
177051032706	79128	3202	5	10	130	Φ12	Kamaz
177012630877		3202	1	26	130	Φ14	

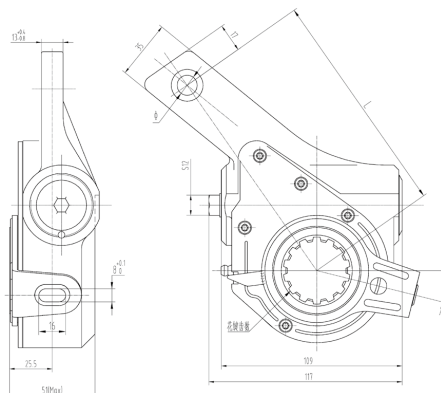

SORL	Cross	Cast	Control Arm No.	Spline Teeth	L1	Bush Dia	Applic.
353022510287	72585	3226	2	25	135	Φ14	Temsa
353052833405	12132	3226	5	28	127	Φ12.7	Foden
353051033555	72019	3226	5	10	127	Φ12.7	Leyland
353052833555	72180	3226	5	28	127	Φ12.7	Foden
353051033255	72198	3226	5	10	127	Φ12.7	Seddon
353052833255	72199	3226	5	28	127	Φ12.7	Foden
353012630307	72348	3226	1	26	130	Φ14	MAN
	72613						
	72975						
	79215						
353012630387	72515	3226	1	26	130	Φ14	MAN
	79202						
353011030228	72777	3226	1	10	135	Φ16	HMC
353011033528	72779	3226	1	10	135	Φ16	HMC
353022830755	79184	3226	2	28	127	Φ12.7	Foden
353031410146	79353	3226	3	14	135	Φ12	Foden, Kinglong
353031020555	79464	3226	3	10	125	Φ12.7	Volvo

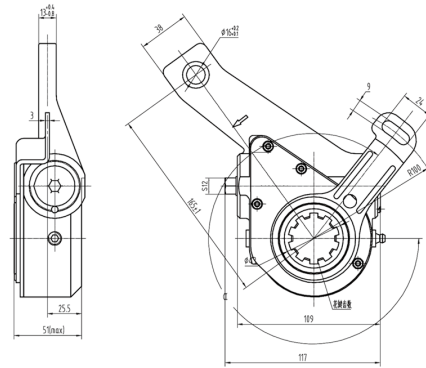

SORL	Cross	Cast	Control Arm No.	Spline Teeth	L1	L2	L3	Bush Dia	Applic.
986012740707	12310	3226	1	27	180			Φ14	
986041033058	70801	3226	4	10	180			Φ16	Scaina
	72947								
	70864								
	72963								
986031030307	70871	3226	3	10	140		Φ14	DAF	
986032830305	79177	3226	3	28	140		Φ12.7	Optare	
986031920057	72016	3226	3	19	145		Φ12.7	Kassbonnet	
986052833555	72181	3226	5	28	140			Φ14	Foddon
	79682								
986051033555	72114	3226	5	10	140		Φ12.7	Seddon	
986021033397	72117	3226	2	10	140			Φ14	DAF
986021023397	72530								
986021023407	72540	3226	2	10	165		Φ14	DAF	
986011031037	72182	3226	1	10	140		Φ14		
986021031557	72202	3226	2	10	140			Φ14	DAF
986021021557	72535								
986011210005	79070	3226	1	12	150		Φ12.7		
986011410005	79096	3226	1	14	150		Φ12.7		
986031040005	72030	3226	3	10	178		Φ12.7	Bombardier	
986011030007	72309	3226	1	10	165			Φ14	DAF
986011020007	72541								
986011030407	72327	3226	1	10	165			Φ14	DAF
986011020407	72547								
986032030417	79079	3226	3	20	175		Φ14	Raba	
986021030588		3226	2	10	165		Φ16		
986051021807	72558	3226	5	10	140		Φ14		
986051043088	72662	3226	5	10	165			Φ16	Scania
986051033088	72467								
986011030228	72778	3226	1	10	145		Φ16		
986011410525	72820		1	14	150		Φ12.7		
986021013527	79329	3226	2	10	127	152	178	Φ14	SAF
986011023525	79117		1	10	140		Φ12.7		
986011033528	79557	3226	1	10	145		Φ16		
986032433525	79648		3	24	140				North Benz

SORL	Cross	Cast	Control Arm No.	Spline Teeth	L1	L2	L3	Bush Dia	Applic.
986022533537	79661	3226	2	25	165	135		Φ14	JPB
986011010637	72837	3226	1	10	178	153		Φ14	SAE
986051023027	72862	3226	5	10	178	152	127	Φ14	Ruth mann
986052833087	79080	3226	5	28	165			Φ14	ROR
986052833405	72864	3226	5	28	140			Φ12.7	Foden
986032833428	79247	3226	3	28	140			Φ16	
986051021755	79161	3226	5	10	140			Φ12.7	Volvo
	79428								
986032020257	79390	3226	3	20	140			Φ14	
986011010457	79419	3226	1	10	178	153		Φ14	
986022830755	79461	3226	2	28	140			Φ12.7	Foden
986102510108	41910824	3226	10	25	145			Φ16	HMC

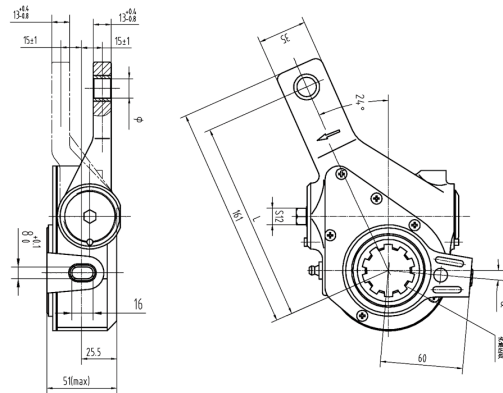

SORL	Cross	Cast	Control Arm No.	Spline Teeth	L1	Bush Dia	Applic.
782031020065	70909	3861	3	10	134	Φ12.7	Volvo
	72723						
782031020055	72152	3861	3	10	145	Φ12.7	Volvo DC
	72782						
782022633467	72061	3861	2	26	145	Φ14	DC
782031020045	72784	4039(3861instead)					Volvo
783022633467	72060	3860	2	26	145	Φ14	DC
783031020065	70910	3860	3	10	134	Φ12.7	Volvo
	72724	3860	3	10	134	Φ12.7	Volvo
783031020055	72153	3860	3	10	145	Φ12.7	Volvo
	72783						
783031020045	72785	4038(3860instead)	3	10	165	Φ12.7	Volvo

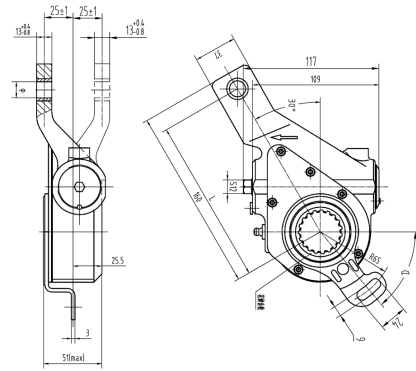

SORL	Cross	Cast	Control Arm No.	Spline Teeth	L1	Bush Dia	Applic.
203011930507	72203	3863	1	19	145	Φ14	ZF, Neoplan DC
	79429						
203011930505	72520	3863	1	19	145	Φ12.7	
204011930507	72204	3864	1	19	145	Φ14	ZF, Neoplan DC
	79430						
204011930505	72519	3864	1	19	145	Φ12.7	

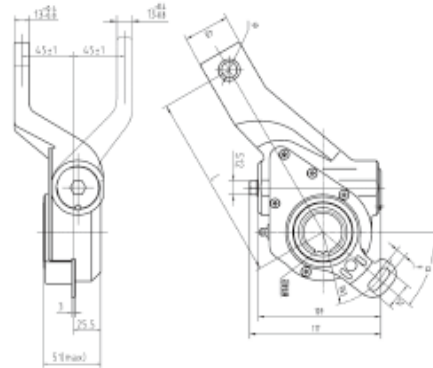

SORL	Cross	Cast	Control Arm No.	Spline Teeth	L1	L2	L3	L4	L5	L6	L7	Bush Dia	Applic.
931011020407	72538	4042	1	10	165							Φ14	DAF
931011930507	79637	4042	1	19	145							Φ14	ZF
932011020407	72539	4043	1	10	165							Φ14	DAF
932011930507	79638	4043	1	19	145							Φ14	ZF

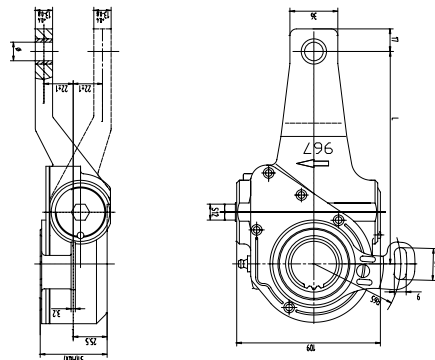

SORL	Cross	Cast	Control Arm No.	Spline Teeth	L1	L2	L3	L4	L5	L6	L7	Bush Dia	Applic.
968032711007	79153	2754	3	27	183							Φ14	

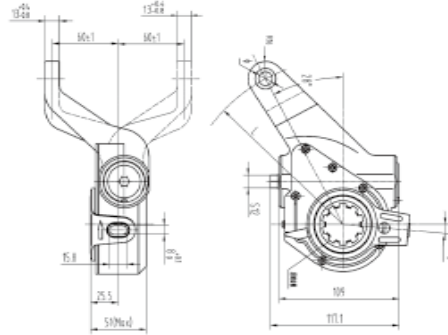

SORL	Cross	Cast	Control Arm No.	Spline Teeth	L1	L2	L3	L4	L5	L6	L7	Bush Dia	Applic.
933032530058	79418	4106	3	25	150							Φ16	
933012530058	79251	4106	1	25	150							Φ16	
934032530058	79417	4105	3	25	150							Φ16	
934012530058	79250	4105	1	25	150							Φ16	

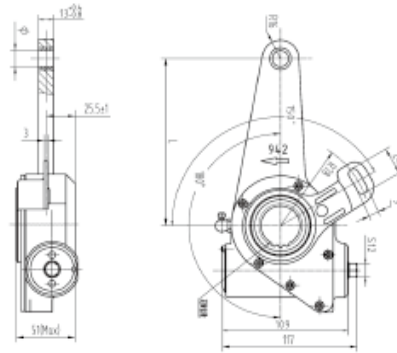

SORL	Cross	Cast	Control Arm No.	Spline Teeth	L1	L2	L3	L4	L5	L6	L7	Bush Dia	Applic.
942022631507	79186	4096	2	26	145							Φ14	DC

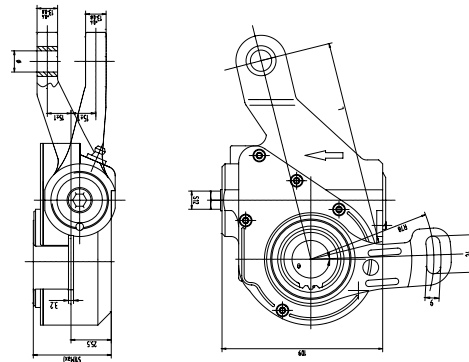

SORL	Cross	Cast	Control Arm No.	Spline Teeth	L1	L2	L3	L4	L5	L6	L7	Bush Dia	Applic.
943022633587	72211	4035	2	26	130							Φ14	

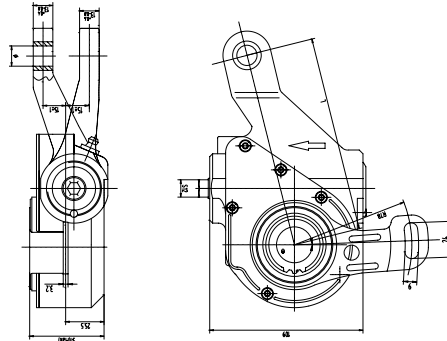

SORL	Cross	Cast	Control Arm No.	Spline Teeth	L1	L2	L3	L4	L5	L6	L7	Bush Dia	Applic.
944022633587	72212	4036	2	26	130							Φ14	

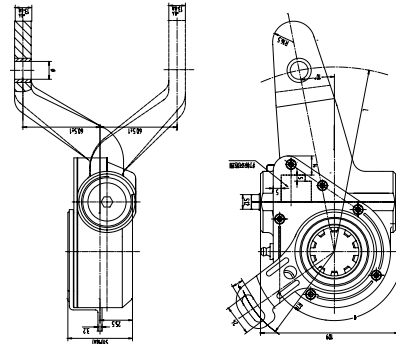

SORL	Cross	Cast	Control Arm No.	Spline Teeth	L1	L2	L3	L4	L5	L6	L7	Bush Dia	Applic.
947021021437	KB2730		2	10	145							Φ14	DAF
947021023397	72705		2	10	145							Φ14	DAF
948021021437	KB2725		2	10	145							Φ14	DAF
948021023397	72704		2	10	145							Φ14	DAF

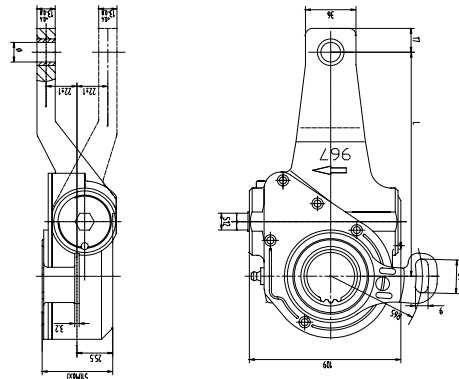

SORL	Cross	Cast	Control Arm No.	Spline Teeth	L1	L2	L3	L4	L5	L6	L7	Bush Dia	Applic.
967032711007	79152	2753	3	27	183							Φ14	

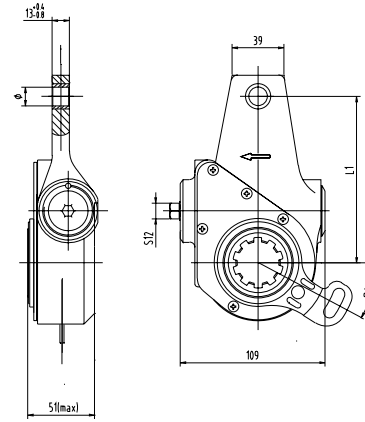

SORL	Cross	Cast	Control Arm No.	Spline Teeth	L1	Bush Dia	Applic.
678031031507	11011	4104	3	10	140	Φ14	Bova
678031021515	79271	4104	3	10	127	Φ12.7	Volvo
	72246						
678031021505	70902	4104	3	10	140	Φ12.7	Volvo
	72667						
678031031505	72027						
	72677						
678011021506	79571	4104	1	10	125	Φ12	
678031051355	70510	4104	3	10	114	Φ12.7	Leyland
678031941157	70726	4104	3	19	122	Φ14	Jeletz
678011051155	70851	4104	1	10	140	Φ12.7	Sisu
678031031005	11029	4104	3	10	127	Φ12.7	Faton
678032830905	12319	4104	3	28	140	Φ12.7	
678032830915	12320	4104	3	28	130	Φ12.7	
	72021						
678031030905	72021	4104	3	10	127	Φ12.7	Volvo
	72725						
678031031105	70513	4104	3	10	140	Φ12.7	DAF
678011031105	12360	4104	1	10	125	Φ12.7	
678031021107	72011	4104	3	10	127	Φ14	DAF
678031031117	70823	4104	3	10	140	Φ14	DAF
678031021305	70858	4104	3	10	140	Φ12.7	
678031050755	72457	4104	3	10	140	Φ12.7	Foden Dennis, MCW Dennis
	70859						
678031030755	72393						
678031020755	72425						
678031040745	72575	4104	3	10	102	Φ12.7	Dana
678031040735	72190	4104	3	10	114	Φ12.7	Dana, MCW
678031040765	72189	4104	3	10	108	Φ12.7	Dana, MCW
678011060505	70906	4104	1	10	140	Φ12.7	Leyland, Setra
678021051605	70986	4104	2	10	140	Φ12.7	Dennis
678041033058	72910	4104	4	10	130	Φ16	Scania
678031080305	72085	4104	3	10	133	Φ12.7	Volvo
678031040155	72145	4104	3	10	127	Φ12.7	Dennis
678031030155	72362						

SORL	Cross	Cast	Control Arm No.	Spline Teeth	L1	L2	Bush Dia	Applic.
678031030165	72367	4104	3	10	140		Φ12.7	Dennis
678031020165	72333							
678041021725	72166	4104	4	10	140		Φ12.7	Volvo
	72678							
678021033397	72197	4104	2	10	140		Φ14	DAF
678021023397	72534							
678012733507	72328	4104	1	27	140		Φ14	RVI
	79019							
678032423505	72610	4104	3	24	140		Φ12.7	
678031050655	82361	4104	3	10	115		Φ12.7	MCW
678031050645	72499	4104	3	10	140		Φ12.7	
678031050665	79062	4104	3	10	140		Φ12.7	
678021033415	72364	4104	2	10	127		Φ12.7	Dennis
678011010805	72405	4104	1	10	115	115	Φ12.7	Leyland
	72195							
678011010815	72406	4104	1	10	133		Φ12.7	Leyland
678011010795	72407	4104	1	10	140		Φ12.7	Leyland
678012631057	72438	4104	1	26	130		Φ14	MAN
	79218							
	72980							
678021021557	72550	4104	2	10	140		Φ14	DAF
678021031555	72643	4104	2	10	140		Φ12.7	Steyr
678021033405	72644	4104	2	10	140		Φ12.7	Dennis
678031030905	72021	4104	3	10	127		Φ12.7	Volvo
	72725							
678032430905	79411	4104	3	24	140		Φ12.7	EGE FREN
678011920907	79539	4104	1	19	122		Φ14	
678021020906	79517	4104	2	10	140		Φ12	
678011020366	79646	4104	1	10	110		Φ12	DongFeng
678012530905	79103	4104	1	25	125		Φ12.7	Nissan
678011030008	72735	4104	1	10	133		Φ16	
678032830005	79267	4104	3	28	140		Φ12.7	Mercury
678012730007	72100	4104	1	27	140		Φ14	RVI
	79012							
678011020305	72935	4104	1	10	140		Φ12.7	ROR
678031020605	79072	4104	3	10	140		Φ12.7	Volvo
678031020605	79564	4104	3	10	140		Φ12.7	Volvo
678031921207	79230		3	19	122		Φ14	
678030821207	79233	4104	3	8	122		Φ14	
678031410496	79354	4104	3	14	120		Φ12	
678012810107	79548	4104	1	28	130		Φ14	Albion
678011020286	79569	4104	1	10	125		Φ12	
678031030406	79617	4104	3	10	125		Φ12	Dong Feng
678031021306	79618	4104	3	10	125		Φ12	Dong Feng
678031021315	72454	4104	3	10	115		Φ12.7	
678032431305	79647	4104	3	24	140		Φ12.7	North Benz
678011020706	79627	4104	1	10	125		Φ12	DAW

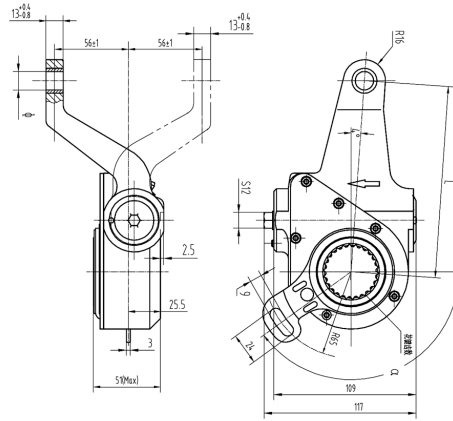

SORL	Cross	Cast	Control Arm No.	Spline Teeth	L1	Bush Dia	Applic.
231031050755	70930	3185	3	10	140	Φ12.7	MCW
231012641007	12170	3185	1	26	145	Φ14	
231082630947	70918	3185	8	26	145	Φ14	DC
231012631017	72069	3185	1	26	145	Φ14	DC Foden
	72937						
231012631447	72173		1	26	145	Φ14	DC
231062631447	72303	3185	6	26	145	Φ14	DC MAN
	72968						
	79208						
	79514						
231051043057	72521	3185	5	10	145	Φ14	Sisa
231011030837	72312	3185	1	10	143	Φ14	DAF
231011020837	72544						
231011020377	72695	3185	1	10	143	Φ14	DAF
231012640437	72940	3185	1	26	145	Φ14	
231012630307	72919	3185	1	26	145	Φ14	DC
231012643557	79002	3185	1	26	145	Φ14	Sisu
231012630007	79099	3185	1	26	145	Φ14	DC
231032020907	79107	3185	3	20	145	Φ14	Raba
231021931157	79231	3185	2	19	145	Φ14	
232012641007	12171	3186	1	26	145	Φ14	
232031050755	70931	3186	3	10	140	Φ12.7	MCW
232012631017	72070	3186	1	26	145	Φ14	DC, Foden
	72938						
232051043057	72522	3186	5	10	145	Φ14	Sisu
232012620837	72527	3186	1	26	143	Φ14	DAF
232011030837	72313	3186	1	10	143	Φ14	DAF
232011020837	72545						
232011020377	72696	3186	1	10	143	Φ14	DAF
232012630307	72920	3186	1	26	145	Φ14	DC
232012640437	72941	3186	1	26	145	Φ14	
232012643557	79003	3186	1	26	145	Φ14	Sisu
232012630007	79100	3186	1	26	145	Φ14	DC
232032020907	79108	3186	3	20	145	Φ14	Raba

SORL	Cross	Cast	Control Arm No.	Spline Teeth	L1	Bush Dia	Applic.
232021931157	79232	3186	2	19	145	Φ14	
232012631447	72174	3186	1	26	145	Φ14	DC
232062631447	79209	3186	6	26	145	Φ14	DC, MAN
	72304						
	72969						
	79515						
232072630947	70917	3186	7	26	145	Φ14	DC

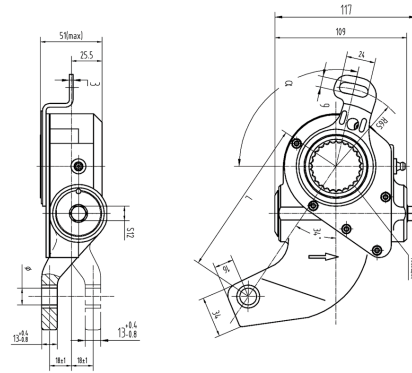

SORL	Cross	Cast	Control Arm No.	Spline Teeth	L1	L2	Bush Dia	Applic.
220012631037	72456	3162	1	26	130		Φ14	DC, MAN
	72810							
	79220							
	72982							
220012630537	72812	3162	1	26	130		Φ14	DC, MAN
	72732							
	72991							
	79229							
220022633397	79210	3162	2	26	145		Φ14	MAN DC Neoplan
	72320							
	70753							
	72970							
219012630537	79228	3163	1	26	130		Φ14	DC, MAN
	72731							
	72990							
	72811							
219012631037	72455	3162	1	26	130		Φ14	DC, MAN
	72809							
	79219							
	72981							
219031061006	79636	3163	3	10	120		Φ12	Somar PL
219022633397	79211	3163	2	26	145		Φ14	MAN DC Neoplan
	72321							
	70754							
	72971							

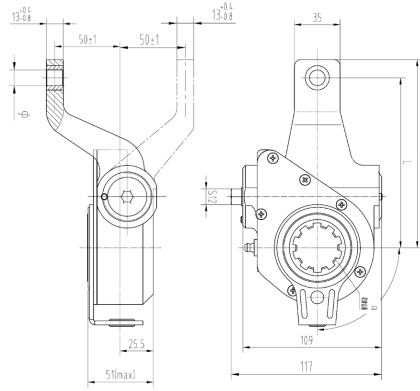

SORL	Cross	Cast	Control Arm No.	Spline Teeth	L1	L2	Bush Dia	Applic.
567011030848	72468	4050	1	10	130		Φ16	Scaina
	72893							
567031020906	79567	4050	3	10	130		Φ12	
567011020206	79575	4050	1	10	130		Φ12	
568011030848	72892	4051	1	10	130		Φ16	Scaina
	72469							
568031020906	79568	4051	3	10	130		Φ12	
568011020206	79576	4051	1	10	130		Φ12	

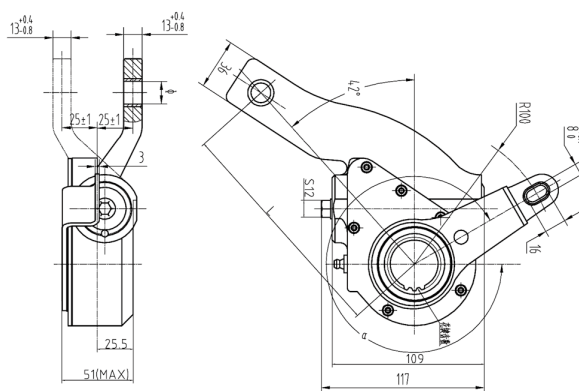

SORL	Cross	Cast	Control Arm No.	Spline Teeth	L1	L2	Bush Dia	Applic.
980041033108	72950	3663	4	10	165		Φ16	Scaina
	70879							
980051033088	72492	3663	5	10	165		Φ16	Scaina
	72625							
980051043088	72661							
981041033108	70878	3662	4	10	165		Φ16	Scaina
	72949							
981051033088	72491	3662	5	10	165		Φ16	Scaina
981051043088	72660							
	72624							

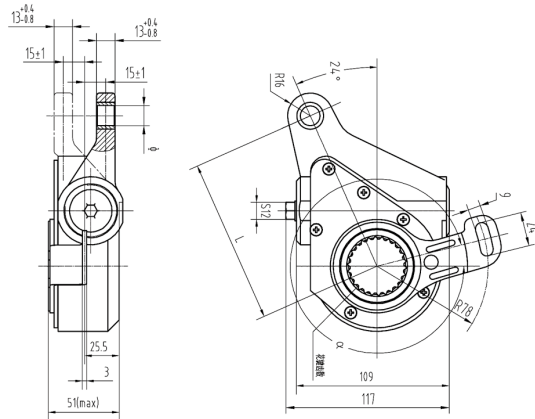

SORL	Cross	Cast	Control Arm No.	Spline Teeth	L1	L2	Bush Dia	Applic.
985022633467	70771	3196	2	26	115		Φ14	DC, MAN Neoplan
	72562							
	79204							
984022633467	70772	3195	2	26	115		Φ14	DC, MAN Neoplan
	79203							
	72561							
984031050405	72452	3195	3	10	115		Φ12.7	MCW

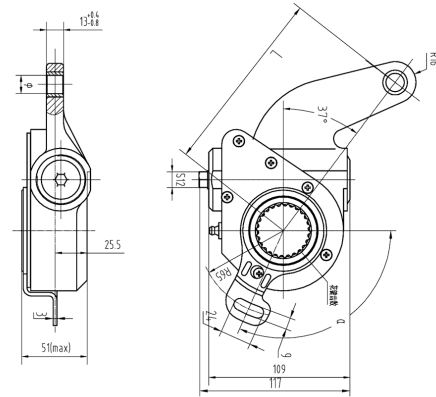

SORL	Cross	Cast	Control Arm No.	Spline Teeth	L1	L2	Bush Dia	Applic.
994022631507	72056	3900	2	26	145		Φ14	DC
994012633587	72059	3900	1	26	145		Φ14	DC
994012631277	72596	3900	1	26	145		Φ14	DC
994011931037	72872	3900	1	19	145		Φ14	ZF
994012631147	79185	3900	1	26	145		Φ14	DC
994031030206	79562	3900	3	10	125		Φ12	
994012631057	79608	3900	1	26	130		Φ14	MAN
994022630077	79656	3900	2	26	145		Φ14	DC
994012630077		3900	1	26	145		Φ14	

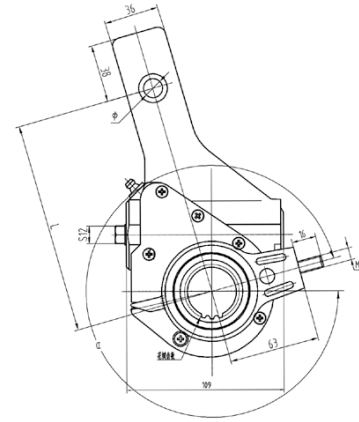
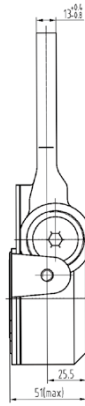

SORL	Cross	Cast	Control Arm No.	Spline Teeth	L1	L2	Bush Dia	Applic.
922092823455	40910551	10098	9	28	140		Φ12.7	

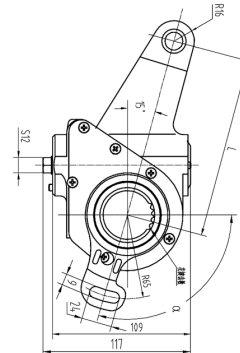
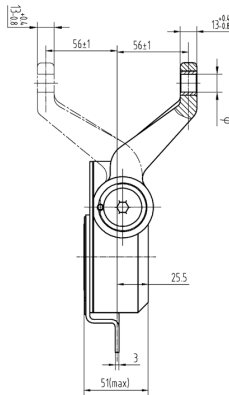

SORL	Cross	Cast	Control Arm No.	Spline Teeth	L1	L2	Bush Dia	Applic.
998012631067	70952	3879	1	26	145		Φ14	DC
998012631017	72013	3879	1	26	145		Φ14	MAN
	72966							
	79206							
998011931007	72689	3879	1	19	145		Φ14	ZF
998012631237	72617	3879	1	26	145		Φ14	DC
998012630167	79074	3879	1	26	145		Φ14	DC
998012631557	79136	3879	1	26	145		Φ14	DC
997012631067	70953	3878	1	26	145		Φ14	DC
997012631237	72616	3878	1	26	145		Φ14	DC
997011931007	72688	3878	1	19	145		Φ14	ZF
997012631017	72012	3878	1	26	145		Φ14	MAN
	79205							
	72965							
997012630167	79073	3878	1	26	145		Φ14	DC
997012631557	79137	3878	1	26	145		Φ14	DC

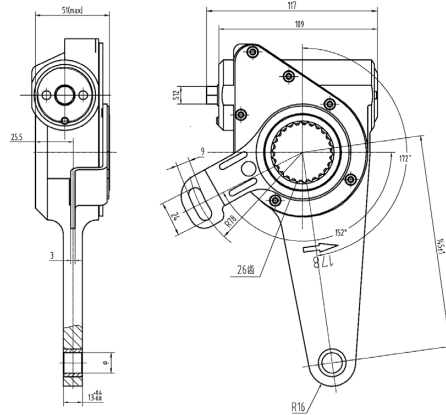

SORL	Cross	Cast	Control Arm No.	Spline Teeth	Bush Dia	Applic.
178022631527	72178	4049	2	26	Φ14	DC

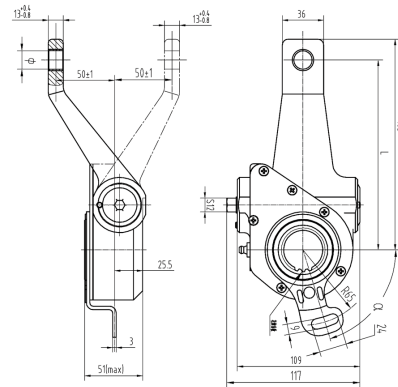

SORL	Cross	Cast	Control Arm No.	Spline Teeth	L1	Bush Dia	Applic.
978011030588	72477	3705	1	10	165	Φ16	Scania
978011040588	72666 72626						
978011040738	72620 72663	3705	1	10	165	Φ16	Scania
978061040437	79350	3705	6	10	165	Φ14	Foden
978041033345	79276 79678	3705	4	10	165	Φ12.7	Volvo
979011030588	72001 72476	3704	1	10	165	Φ16	Scania
979011040588	72665 72627						
979011030738	72487 72664	3704	1	10	165	Φ16	Scania
979011040738	72621						
979061040437	79349	3704	6	10	165	Φ14	Foden
979041033345	79275 79677	3704	4	10	165	Φ12.7	Scania Volvo

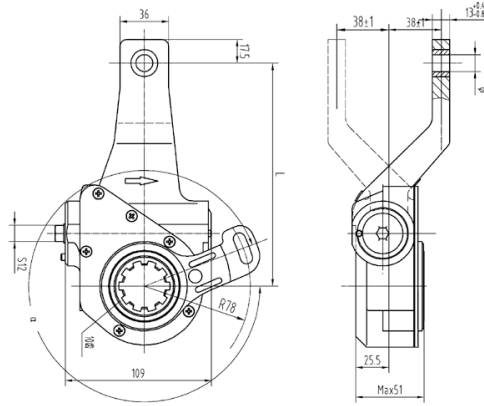

SORL	Cross	Cast	Control Arm No.	Spline Teeth	L1	L2	L3	Bush Dia	Alpha Angle	Applic.
970021053395	10274	2760	2	10	165			Φ12.7	339	Foden
	72417									
970021053405	79599	2760	2	10	200			Φ12.7	339	
970021053397	72150	2760	2	10	165			Φ14	339	
970011930007	79537	2760	1	19	155			Φ14	0	
970021020005	10714	2760	2	10	168			Φ12.7	0	Britsab
970033721107	12112	2760	3	37	203	179	151	Φ14	110	Steer axle
970031021107	70802	2760	3	10	203	179	151	Φ14	110	SAF
970031051355	70511	2760	3	10	178			Φ12.7	135	Leyland
970031061355	70840	2760	3	10	165			Φ12.7	135	Leyland
970031040305	72914	2760	3	10	165			Φ12.7	30	Volvo
	70782									
970031040315	70641	2760	3	10	205	165	140	Φ12.7	30	Volvo
970031030307	79483	2760	3	10	165			Φ14	30	
970031920907	72014	2760	3	19	160			Φ14	90	Kassbohrer
970031920917	70718	2760	3	19	170			Φ14	90	Kassbohrer
970031050755	72140	2760	3	10	165			Φ12.7	75	MCW
970012710107	72319	2760	1	27	175			Φ14	10	RVI
	79018									
970012710117	79299	2760	1	27	160			Φ14	10	RVI
	72835									
970031921407	72368	2760	3	19	175			Φ14	140	Kassbohrer
970031941407	79236									
970031951407	79040									
970051921807	72370	2760	5	19	175			Φ14	180	Kassbohrer
970032851505	72372	2760	3	28	175			Φ12.7	150	Kassbohrer
970021021557	72532	2760	2	10	165			Φ14	155	DAF
970021051555	79156	2760	2	10	165			Φ12.7	155	Dennis
970012711257	72634	2760	1	27	175			Φ14	125	RVI
970061021457	79028	2760	6	10	203	179	151	Φ14	145	Stefen
970061011447	79336	2760	6	10	179	152		Φ14	144	SAF
	79043									
970061011437	79495	2760	6	10	179	140		Φ14	144	
970061011277	79142	2760	6	10	178	153		Φ14	127	

SORL	Cross	Cast	Control Arm No.	Spline Teeth	L1	L2	L3	Bush Dia	Applic.
970061011287	79449	2760	6	10	165			Φ14	
970011031207	79258	2760	1	10	165			Φ14	Kamaz
970032630357	79510	2760	3	26	175			Φ14	Tatra
970012733507	79465	2760	1	27	160			Φ14	RVI
	79683								
970012830107	72741	2760	1	28	160			Φ14	RVI
	79289								
970012833507	72997	2760	1	28	160			Φ14	RVI
	79304								
970012713517	79000	2760	1	27	175			Φ14	RVI
	79306								
971021053405	79600	2761	2	10	200			Φ12.7	Aluis
971021053395	72418	2761	2	10	165			Φ12.7	Foden
	10275								
971021020005	10715	2761	2	10	168			Φ12.7	Britsab
971011930007	79538	2761	1	19	155			Φ14	
971033721107	12113	2761	3	37	203	179	151	Φ14	Stuuras
971031021107	70803	2761	3	10	203	179	151	Φ14	SAF
971031051355	70512	2761	3	10	178			Φ12.7	Leyland
971031061365	70841	2761	3	10	165			Φ12.7	Leyland
971031040315	70642	2761	3	10	205	165	140	Φ12.7	Volvo
971031040305	72904	2761	3	10		165		Φ12.7	Volvo
	70781								
971031030307	79484	2761	3	10	165			Φ14	
971031920907	70719	2761	3	19	170			Φ14	Kassbohrer
971031920917	72015	2761	3	19	160			Φ14	Kassbohrer
971031050755	72141	2761	3	10	165			Φ12.7	MCW
971031921407	72369	2761	3	19	175			Φ14	Kassbohrer
971031951407	79041								
971031941407	79237								
971051921807	72371	2761	5	19	175			Φ14	Kassbohrer
971032851505	72373	2761	3	28	175			Φ12.7	Kassbohrer
971021021557	72533	2761	2	10	165			Φ14	DAF
971021051555	79157	2761	2	10	165			Φ12.7	Dennis
971012710107	72836	2761	1	27	160			Φ14	RVI
	79300								
971012710117	79017	2761	1	27	175			Φ14	RVI
	72318								
971061011447	79044	2761	6	10	179	152		Φ14	SAF
	79337								
971061011437	79496	2761	6	10	179	140		Φ14	
971011031207	79259	2761	1	10	165			Φ14	Kassbohrer
971032630357	79511	2761	3	26	175			Φ14	Tatra
971012733507	79466	2761	1	27	160			Φ14	RVI
	79684								

SORL	Cross	Cast	Control Arm No.	Spline Teeth	L1	L2	L3	Bush Dia	Applic.
971012711257	72633	2761	1	27	175			Φ14	RVI
971061011277	79450	2761	6	10	165			Φ14	
971061011287	79143	2761	6	10	178	153		Φ14	
971012830107	72740	2761	1	28	160			Φ14	RVI
	79288								
971012713517	79001	2761	1	27	175			Φ14	RVI
	79307								
971012833507	79305	2761	1	28	160			Φ14	RVI
	72998								
971061021457	79029	2761	6	10	203	179	151	Φ14	Stefen

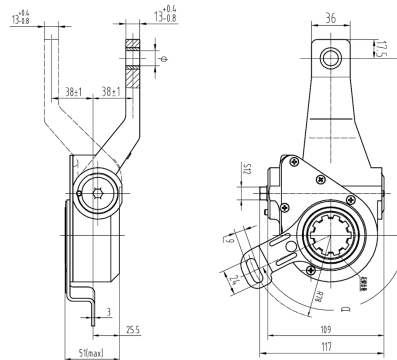

SORL	Cross	Cast	Control Arm No.	Spline Teeth	L1	Bush Dia	Applic.
254031031507	10868	2760	3	10	140	Φ14	DAF
254021030005	10937	2760	2	10	140	Φ12.7	Dennis
254021020007	72586	2760	2	10	140	Φ14	DAF
254011030007	12116	2760	1	10	152	Φ14	
254031021307	12141	2760	3	10	140	Φ14	
254031040305	70647	2760	3	10	152	Φ12.7	Volvo
	72806						
254031040315	70649	2760	3	10	140	Φ12.7	Volvo
	72912						
254032830305	72431	2760	3	28	152	Φ12.7	Steyr
254031031107	70824	2760	3	10	140	Φ14	DAF, ROR
254031021107	72917						
254031050755	70893	2760	3	10	140	Φ12.7	Dana, MCW
254031050757	72815	2760	3	10	140	Φ14	DAF
254041053305	70977	2760	4	10	152	Φ12.7	Volvo
254031921355	12254	2760	3	19	150	Φ12.7	Hino
254031061355	70987	2760	3	10	152	Φ12.7	Leyland
254021031557	72107	2760	2	10	140	Φ14	DAF
254021021557	72523						
254031050505	72147	2760	3	10	140	Φ12.7	Dennis, MCW
254021023397	72525	2760	2	10	140	Φ14	DAF
254021053395	79158	2760	2	10	152	Φ12.7	GKN
254031951457	72591	2760	3	19	150	Φ14	Kassbhrer
254011020967	79467	2760	1	10	145	Φ14	
254021430655	79493	2760	2	14	150	Φ12.7	Meinoku

SORL	Cross	Cast	Control Arm No.	Spline Teeth	L1	Bush Dia	Applic.
255031031507	10869	2761	3	10	140	Φ14	DAF
255021030005	10938	2761	2	10	140	Φ12.7	Dennis
255011030007	12117	2761	1	10	152	Φ14	
255021020007	72587	2761	2	10	140	Φ14	DAF
255031021307	12142	2761	3	10	140	Φ14	Fruehauf
255031921355	12255	2761	3	19	150	Φ12.7	Hino
255031061355	70988	2761	3	10	152	Φ12.7	Leyland
255031040305	70646	2761	3	10	152	Φ12.7	Volvo
	72805						
255031040315	70648	2761	3	10	140	Φ12.7	Volvo
	72911						
255032830305	72430	2761	3	28	152	Φ12.7	Steyr
255031031107	70825	2761	3	10	140	Φ14	DAF, ROR
255031021107	72918						
255031050755	70894	2761	3	10	140	Φ12.7	Dana, MCW
255031050757	72816	2761	3	10	140	Φ14	DAF
255041053305	70978	2761	4	10	152	Φ12.7	Volvo
255021031557	72108	2761	2	10	140	Φ14	DAF
255021021557	72524						
255031050505	72148	2761	3	10	140	Φ12.7	Dennis, MCW
255031951457	72592	2761	3	19	150	Φ14	Kassbohrer
255021053395	79159	2761	2	10	152	Φ12.7	GKN
255021023397	72526	2761	2	10	140	Φ14	DAF
255011020967	79468	2761	1	10	145	Φ14	
255021430655	79494	2761	2	14	150	Φ12.7	Meihoku

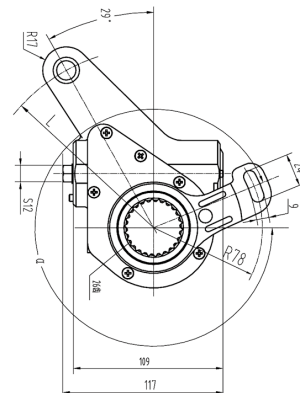
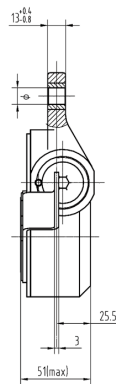

SORL	Cross	Cast	Control Arm No.	Spline Teeth	L1	Bush Dia	Applic.
993012630617	70706	3078	1	26	115	Φ14	DC, N, Neoplan
993022633427		3078	2	26	128	Φ14	
993022633387	72213	4037	2	26	130	Φ14	DC

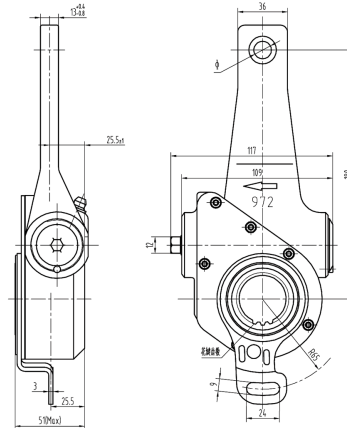

SORL	Cross	Cast	Control Arm No.	Spline Teeth	L1	L2	L3	L4	Bush Dia	Applic.
972011950007	70764	2752	1	19	180		135		Φ14	Saurer
972031020007	12307	2752	3	10	180		150		Φ14	TMM
972031020017	72249	2752	3	10	203	152	178		Φ14	Scania
972031043597	72103	2752	3	10	200	118	142		Φ14	Fruehauf
972031063595	70787	2752	3	10	203		151		Φ12.7	Leyland
972031043585	70886	2752	3	10	190		140		Φ12.7	ROR
972031060005	70945	2752	3	10	180				Φ12.7	Leyland
972031050005	72563									
972031020015	70576	2752	3	10	203	178	152	127	Φ12.7	ROR, SAB
972031040015	70882									
972031060025	72086	2752	3	10	203		171		Φ12.7	Leyland
972031040035	72031	2752	3	10	200	118	142		Φ12.7	Fruehauf
972033740005	70979	2752	3	37	203	152	178		Φ12.7	Fruehauf
972031440005	79533	2752	3	14	180				Φ12.7	
972060831555	72419	2752	6	8	180				Φ12.7	Sicra
972061931557	72709	2752	6	19	180				Φ14	Iveco Regaso
972033741557	70989	2752	3	37	180				Φ14	Kassbohrer
972011071107	70752	2752	1	10	180				Φ14	Bergische
972031021107	70678	2752	3	10	180	120	150		Φ14	BPW
972031041117	72554	2752	3	10	203				Φ14	SAF
972031041097	72448	2752	3	10	210	150	180		Φ14	BPW
972031021127	72334	2752	3	10	200	130	155		Φ14	SAF
972031030708	70598	2752	3	10	165				Φ16	Scania
972031930705	79532	2752	3	19	190		150		Φ12.7	
972031420705	79427	2752	3	14	190		150		Φ12.7	Leyland
972031061355	70634	2752	3	10	179				Φ12.7	Kassbohrer
972033740907	70687	2752	3	37	180	150			Φ14	
972022550907	79255	2752	2	25	190	160	130		Φ14	Yosoki
972022520907	79626									
972010830905	70919		1	8	180				Φ12.7	Sicca
972011950507	70762	2752	1	19	180	135			Φ14	Saurer
972011020467	70804	2752	1	10	210	180	150	120	Φ14	
972011010457	79328	2752	1	10	210	180	150	125	Φ14	SAF
	72710									

SORL	Cross	Cast	Control Arm No.	Spline Teeth	L1	L2	L3	L4	Bush Dia	Applic.
972031021405	70842	2752	3	10	203	178	152	127	Φ12.7	Fruehauf
972013720107	70854	2752	1	37	210	180	150	125	Φ14	Fruehauf
972013721007	70959	2752	1	37	210	180	155	130	Φ14	Fruehauf
972011020207	79502	2752	1	10	210	180	150	125	Φ14	SAF, BPW
	72053									
972031040605	72115	2752	3	10	200	142	118		Φ12.7	Frue hauf
972031040615	70887	2752	3	10	203	178	152	127	Φ12.7	SAB
972031050625	72143	2752	3	10	190				Φ12.7	Mil
972021053395	72144	2752	2	10	165				Φ12.7	Dana, MCW
972012711037	79303	2752	1	27	190				Φ14	RVI
	72840									
972032030757	79056	2752	3	20	175				Φ14	Raba
972052833255	79082	2752	5	28	165				Φ12.7	Marshall
972031080305	79735	2752	3	10	155	127			Φ12.7	GKN
972010830125	70891	2752	1	8	170				Φ12.7	Fiat
972031010127	79342	2752	3	10	203	178	152	127	Φ14	SAF
	79090									
972022510055	79104	2752	2	25	155	129			Φ12.7	
972061011277	79444	2752	6	10	203				Φ14	Comauto
972022530035	79544	2752	2	25	185	155	129		Φ12.7	
972022520035	79545									
972022521445	79541	2752	2	25	155	129			Φ12.7	
972011031277	79595	2752	1	10	180	155	130		Φ14	
972011021277	79574									
972022520565	79543	2752	2	25	155	129			Φ12.7	
972011930247	72408	2752	1	19	180				Φ14	Enasa
972022530237	79652	2752	2	25	195	165			Φ14	Nissan
972032021357	72928	4085	3	20	155	127			Φ14	Raba
972021050635	79071	2752	2	10	165				Φ12.7	Dana
972121020695	4W1235	2752	12	10	190	165	140		Φ12.7	
972121020685	4W1235-1	2752	12	10	165	140			Φ12.7	
972111020605	79685	2752	11	10	190	165	140		Φ12.7	Dong

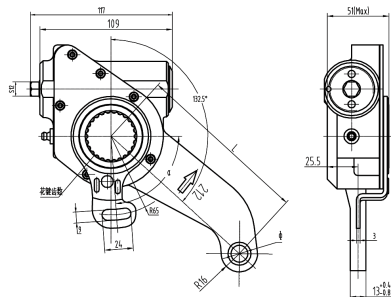

SORL	Cross	Cast	Control Arm No.	Spline Teeth	L1	Bush Dia	Applic.
212022630757	70867	3177	2	26	145	Φ14	DC MAN
	72308						
	72322						
	79212						
	72972						
212012630867	70954	4024	1	26	145	Φ14	DC

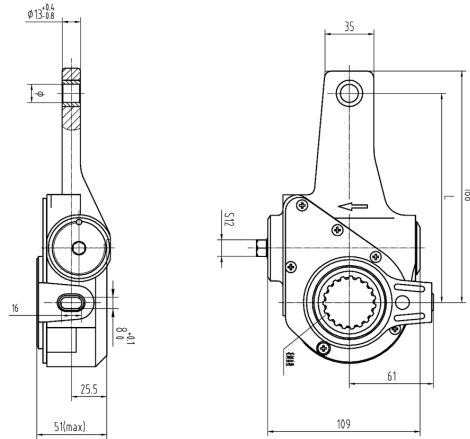

SORL	Cross	Cast	Control Arm No.	Spline Teeth	L1	Bush Dia	Applic.
256031920005	12256	2752	3	19	150	Φ12.7	Hino
256031040015	79169	2752	3	10	140	Φ12.7	Foden
256031430005	79460	2752	3	14	150	Φ12.7	
256031440005	79490						
256031420005	79516 79553						
256031070755	70573	2752	3	10	140	Φ12.7	Scania
256012631107	72967	2752	1	26	145	Φ14	MAN
	79207						
	72208						
256021053505	72149	2752	2	10	140	Φ12.7	Bedtord
256032840905	72376	2752	3	28	145	Φ12.7	Kassbohrer
256031041505	70941	2752	3	10	152	Φ12.7	Volvo
256031041515	70946	2752	3	10	140	Φ12.7	Volvo
256031040155	72363	2752	3	10	140	Φ12.7	Dennis
256012730157	79011	2752	1	27	150	Φ14	RVI
	72099						
256031040905	72905	2752	3	10	127	Φ12.7	Volvo
	70740						
256012631357	72865	2752	1	26	145	Φ14	MAN
	79695						
256031920305	72697	2752	3	19	150	Φ12.7	Nishaiami
256031080305	72517	2752	3	10	145	Φ12.7	Volvo
256012631187	72989	2752	1	26	145	Φ14	MAN
	79227						
	72578						
256031920705	72698	2752	3	19	150	Φ12.7	Nishaiami
256021430655	79437	2752	2	14	150	Φ12.7	
256031420705	79436	2752	3	14	150	Φ12.7	
256011030007	70905	2752	1	10	152	Φ14	Van Hool
256031920457	70720	2752	3	19	145	Φ14	Kassbohrer
256012530408	72858	2752	1	25	150	Φ16	HMC, TATA
256032530408	79416	2752	2	25	150	Φ16	Daewoo

SORL	Cross	Cast	Control Arm No.	Spline Teeth	L1	Bush Dia	Applic.
256011930507	72326	2752	1	19	152	Φ14	ZF
256010820757	79234	2752	1	8	145	Φ14	
256032410005	1A222822	2752	3	24	140	Φ12.7	
256103720665	40010213	2752	10	37	140	Φ12.7	Trailer
256041021725	72726	2752	4	10	152	Φ12.7	Volvo
256011020517	79487	2752	1	10	145	Φ14	
256010821477	79469	2752	1	8	145	Φ14	

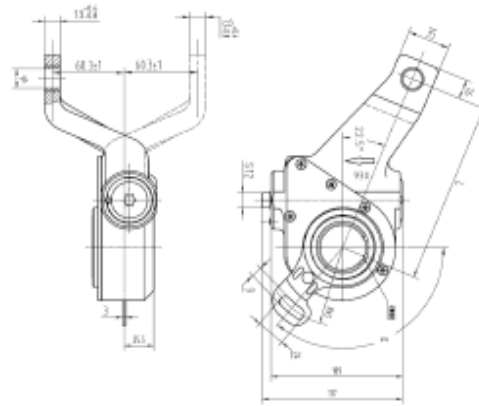

SORL	Cross	Cast	Control Arm No.	Spline Teeth	L1	Bush Dia	Applic.
929031921355	10283	2901	3	19	150	Φ12.7	Hino
929031231355	11031	2901	3	12	150	Φ12.7	
929031241355	79434						
929032511308	79480	2901	3	25	150	Φ16	
929032531308	79414						
929012531308	72856	2901	1	25	150	Φ16	HMC, Daewoo
929021033395	72344	2901	2	10	151	Φ12.7	
929022511447	72583	2901	2	25	145	Φ14	JPB
929022531447	79659						
929011930905	79422	2901	1	19	150	Φ12.7	
929012621137	79377	2901	1	26	155	Φ14	
929032530408	79412	2901	3	25	150	Φ16	
929011210685	72818	2901	1	12	150	Φ12.7	
930031921355	10284	2902	3	19	150	Φ12.7	
930031241355	79435	2902	3	12	150	Φ12.7	
930031231355	11032						
930021033395	72345	2902	2	10	151	Φ12.7	
930022511447	72584	2902	2	25	145	Φ14	Jemsa JPB
930022531447	79660						
930012531308	72857	2902	1	25	150	Φ16	HMC, Daewoo
930032531308	79415	2902	3	25	150	Φ16	Daewoo
	79759						
	79481						
930011930905	79423	2902	1	19	150	Φ12.7	
930012621137	79378	2902	1	26	155	Φ14	
930032530408	79413	2902	3	25	150	Φ16	
930011210685	72819	2902	1	12	150	Φ12.7	

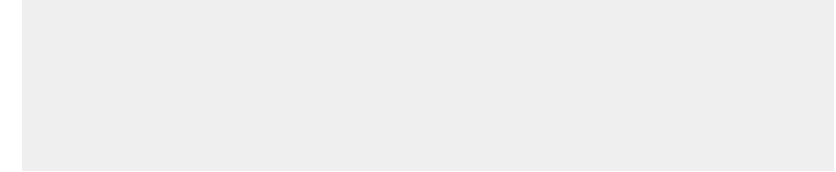

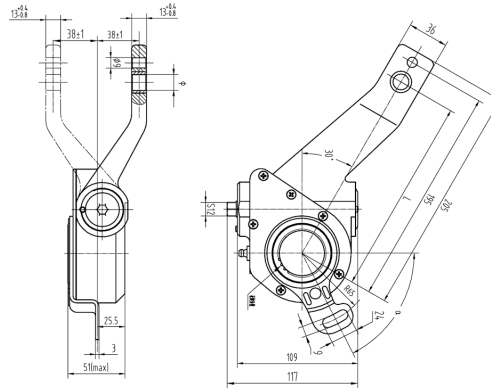

SORL	Cross	Cast	Control Arm No.	Spline Teeth	L1	Bush Dia	Applic.
983032731557	79007	4008	3	27	175	Φ14	RVI
	72005						
983032711557	79009	4008	3	27	175	Φ14	RVI
	72089						
983062711557	79015	4008	6	27	175	Φ14	RVI
	72162						
983062711567	79256	4008	6	27	160	Φ14	RVI
	79535						
983011030637	79650	4008	1	10	165	Φ14	Kynos
983012710647	72738	4008	1	27	160	Φ14	RVI
	79286						
983012710637	72160	4008	1	27	175	Φ14	RVI
	79013						
983012730637	79312	4008	1	27	175	Φ14	RVI
	79124						
983012710907	79020	4008	1	27	175	Φ14	RVI
	72346						
983012711357	79301	4008	1	27	160	Φ14	RVI
	72838						
983012711007	79525	4008	1	27	175	Φ14	RVI
982032731557	72006	4009	3	27	175	Φ14	RVI
	79008						
982032711557	79010	4009	3	27	175	Φ14	RVI
	72090						
982062711557	72163	4009	6	27	175	Φ14	RVI
	79016						
982062711567	79257	4009	6	27	160	Φ14	RVI
	79536						
982012710907	72347	4009	1	27	175	Φ14	RVI
	79021						
982012711357	72839	4009	1	27	160	Φ14	RVI
	79302						

SORL	Cross	Cast	Control Arm No.	Spline Teeth	L1	Bush Dia	Applic.
982012710637	72161	4009	1	27	175	Φ14	RVI
	79014						
982012730637	79313						
	79125						
982012710627	79287	4009	1	27	160	Φ14	RVI
	72739						
982012711007	79526	4009	1	27	175	Φ14	RVI
982011030637	79651	4009	1	10	165	Φ14	Kynos

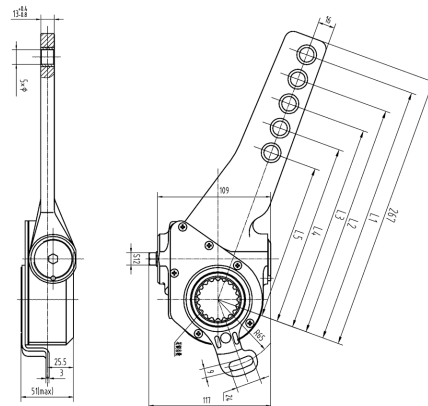

SORL	Cross	Cast	Control Arm No.	Spline Teeth	L1	L2	L3	L4	L5	Bush Dia	Applic.
888031020507	12252	4032	3	10	250	180	155		125	Φ14	
888031021297	72066	4032	3	10	230	178	140			Φ14	Trailer
888031021307	72253	4032	3	10	250	180	150	120		Φ14	BPW
	72263										
	72353										
888031021305	72278	4032	3	10	250	180	150		120	Φ12.7	Eaton
888031011327	72250	4032	3	10	250	210	180	150	125	Φ14	SAF
	79321										
888031011337	72863	4032	3	10	215	181	153	103	129	Φ14	SAF
888031021337	72261	4086	3	10	215	181	153	103	129	Φ14	Trailer/samro Montracon
888031011287	72254	4032	3	10	210	180	150		125	Φ14	SAF
888031021277	72271	4032	3	10	250	195	165		135	Φ14	Kassbohrer
	72416										
888033731107	72252	4032	3	37	250	180	150	120		Φ14	Kassbohrer
888031941287	12356	4032	3	19	130					Φ14	Gorica, Jehz
888030821057	72733	4032	3	8	250	180	155		125	Φ14	Raba/Panav
888012020707	72614	4032	1	20	250	225	200	175	150	Φ14	Retbilds
	72888										
888021020007	79067	4032	2	10	203	127					Retbilds
888111011307	72948	4032	11	10	250	210	180	150	125	Φ14	SAF
888031021375	811014	4032	3	10	203.2	177.8	152	127		Φ12.7	
888033721375	810242	4032	3	37	203.2	177.8	152	127		Φ12.7	
888013720606		4032	1	37	210	180	150	125		Φ12	

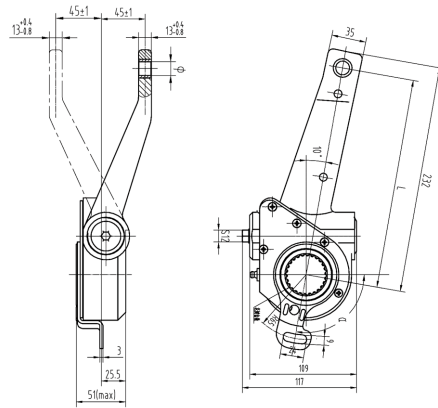

SORL	Cross	Cast	Control Arm No.	Spline Teeth	L1	Bush Dia	Applic.
991012631007	72509	3071	1	26	215	Φ14	MAN
	79224						
	72986						
992012631007	72508	3070	1	26	215	Φ14	MAN
	72985						
	79223						

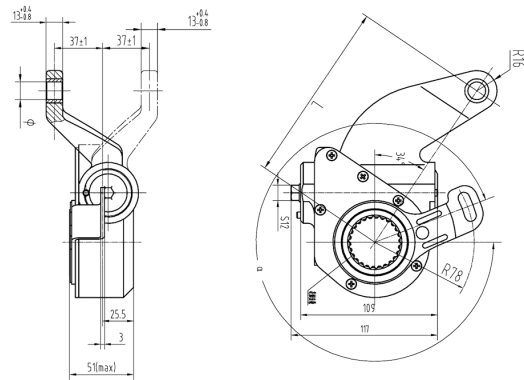

SORL	Cross	Cast	Control Arm No.	Spline Teeth	L1	Bush Dia	Applic.
995022633397	72063	4018	2	26	145	Φ14	D-C
	72235						
	72594						
	79572						
995022633497	79036	4018	2	26	145	Φ14	
996022633397	72062	4019	2	26	145	Φ14	D-C
	72234						
	72593						
	79573						
996022633497	79037	4019	2	26	145	Φ14	

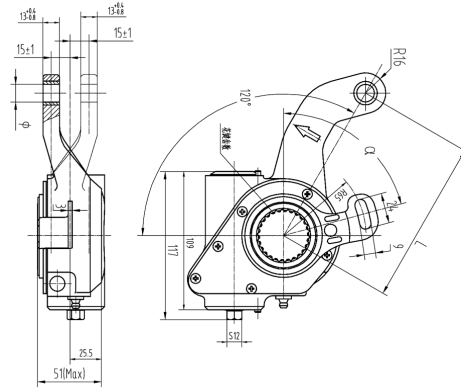

SORL	Cross	Cast	Control Arm No.	Spline Teeth	L1	Bush Dia	Applic.
988142630757	72513	3523	1	26	130	Φ14	MAN
	72988						
	79226						
988012810857	79547	3523	1	28	130	Φ14	Albion
988012630947	79607	3523	1	26	130	Φ14	MAN
987142630757	72512	3522	1	26	130	Φ14	MAN
	72987						
	79225						
987012810857	79546	3522	1	28	130	Φ14	Albion
987012630947	79606	3522	1	26	130	Φ14	MAN

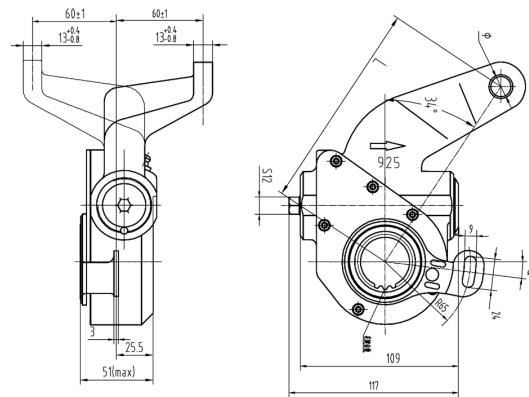

SORL	Cross	Cast	Control Arm No.	Spline Teeth	L1	Bush Dia	Applic.
925012630077	72038	4004	1	26	145	Φ14	D-C
925061031507	72772	4004	6	10	145	Φ14	HMC
925102511517	41910822	4004	10	25	145	Φ14	HMC
926012630077	72039	4005	1	26	145	Φ14	D-C
926061031507	72773	4005	6	10	145	Φ14	HMC
926102511517	41910823	4005	10	25	145	Φ14	HMC

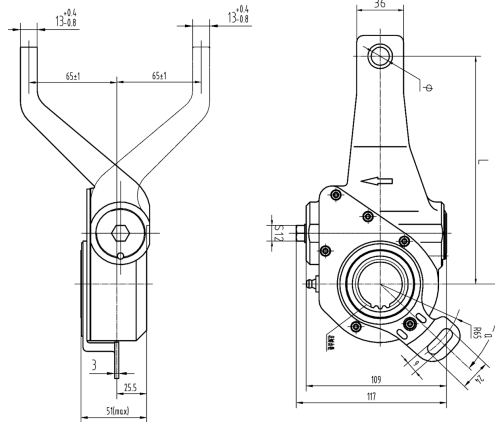

SORL	Cross	Cast	Control Arm No.	Spline Teeth	L1	Bush Dia	Applic.
927011040628	72851	4083	1	10	165	Φ16	Scania
927011041408	72995	4083	1	10	165	Φ16	Scania
	79550						
927011040848	79033	4083	1	10	165	Φ16	Scania
	79442						
927032040907	79245	4083	3	20	165	Φ14	Skoda
928011040628	72852	4084	1	10	165	Φ16	Scania
928011041408	72996	4084	1	10	165	Φ16	Scania
	79551						
928011040848	79034	4084	1	10	165	Φ16	Scania
	79443						
928032040907	79246	4084	3	20	165	Φ 14	Skoda

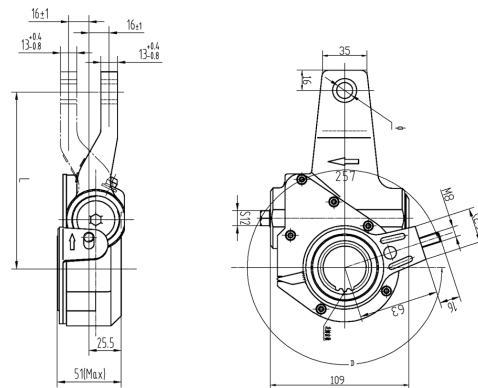

SORL	Cross	Cast	Control Arm No.	Spline Teeth	L1	Bush Dia	Applic.
257092413425	1A222824		9	24	140	Φ12.7	
258092413425	1A222823		9	24	140	Φ12.7	

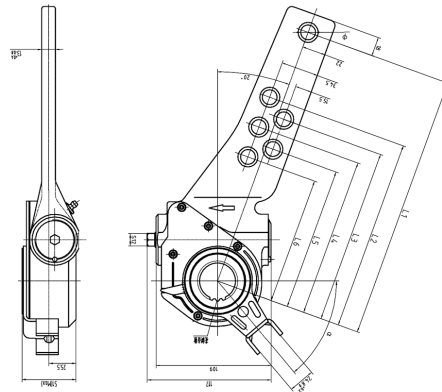

SORL	Cross	Cast	Control Arm No.	Spline Teeth	L1	L2	L3	L4	L5	L6	L7	Bush Dia	Applic.
999031020457	72645	4076	3	10	250	180	130	110				Φ14	SAF/BPW
	79325												
999031021507	72883	4076	3	10	250	180	165	150	135	120		Φ14	SAF/BPW
999031011507	72889												
999030811307	72871	4076	3	8	250	220	200	170					Babelsberger
999031011307	72702	4076	3	10	250	180	155	140	125	105		Φ14	SAF/ROR Volvo
	79326												
999031021307	79160												
999033731107	72758	4076	3	37	250	180	165	150	135		120		Kassbohrer
999031021107	72763	4076	3	10	250	180	165	150	135		120		SAF
999031020507	79327	4076	3	10	250	180	165	150	135	120		Φ14	SAF/BPW
	72703												
999033620507	72861	4076	3	36	250	180	165	150	135		120		Stadtwerke Lausane
999111020507	72875	4076	11	10	250	152	165	150	135	120		Φ14	BPW
999111021107	72876	4076	11	10	250	180	165	150	135	120		Φ14	BPW
999111021117	79649	4076	11	10	250	180	165	150	135	120	105	Φ14	SAE
999110820607	79111	4076	11	8	250	180	165	150	135	120		Φ14	Cardi
999111010617	79619	4076	11	10	238	203	178	140	152	127	114	Φ14	ROR/VH
999111010607	79109	4076	11	10	250	180	155	140	125	105		Φ14	ROR Montenegro
999111020607	79112												
999111031307	79346	4076	11	10	250	180	140	155	125	105		Φ14	SAE/SAF
999111021307	79149												
999111011307	79331												
	79005												
999111011317	79552	4076	11	10	238	203	152	178	140	127	114	Φ14	
960111010627	79235	4076	11	10	205	153	140	127	115			Φ14	ROR
	72788												

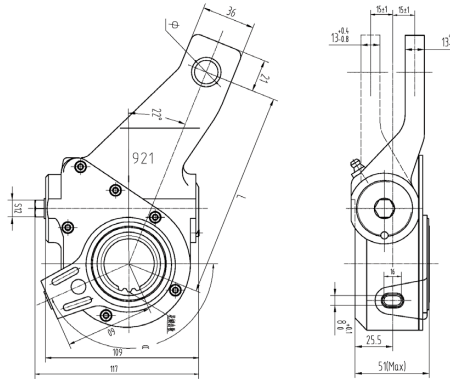

SORL	Cross	Cast	Control Arm No.	Spline Teeth	L1	Bush Dia	Applic.
920031011568	40910820	10078	3	10	140	Φ16	
921031011568	40910819	10077	3	10	140	Φ16	

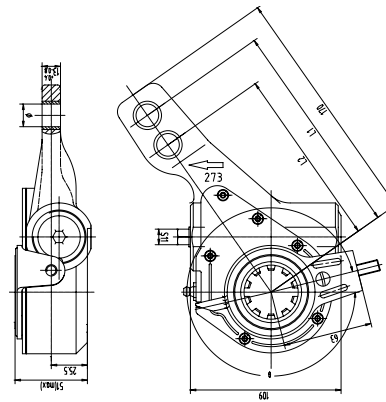

SORL	Cross	Cast	Control Arm No.	Spline Teeth	L1	Bush Dia	Applic.
273091033478M	40010143	10271	9	10	139.7	Φ16	
273091033468M	40010142	10271	9	10	152.4, 127	Φ16	
273092833468M	40010140	10271	9	28	152.4, 127	Φ16	
273092833478M	40010154M1D	10271	9	28	139.7	Φ16	

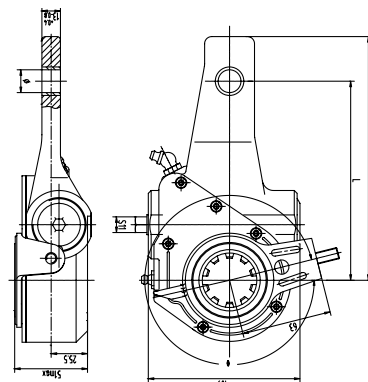

SORL	Cross	Cast	Control Arm No.	Spline Teeth	L1	Bush Dia	Applic.
274091033468M	40010155	10268	9	10	139.7	Φ16	

