



July 4<sup>th</sup> 2018

## ➤ **Electric Air Compressors**

- Lubricated reciprocating air compressors
- Oil free reciprocating air compressors

## ➤ **Electric Power Steering Pumps**

## ➤ **Electric Water Pumps**

**48%** China Domestic OEM Market Share



Electric Air Compressor



Electric Power  
Steering Pump



Electric Water Pump

- Proposed Air braking system for New Energy Vehicles
- Product Range
- SORL Product advantages
- Third party inspection report & Certificates
- Customers
- Application

## 瑞立集团推荐新能源气制动管路

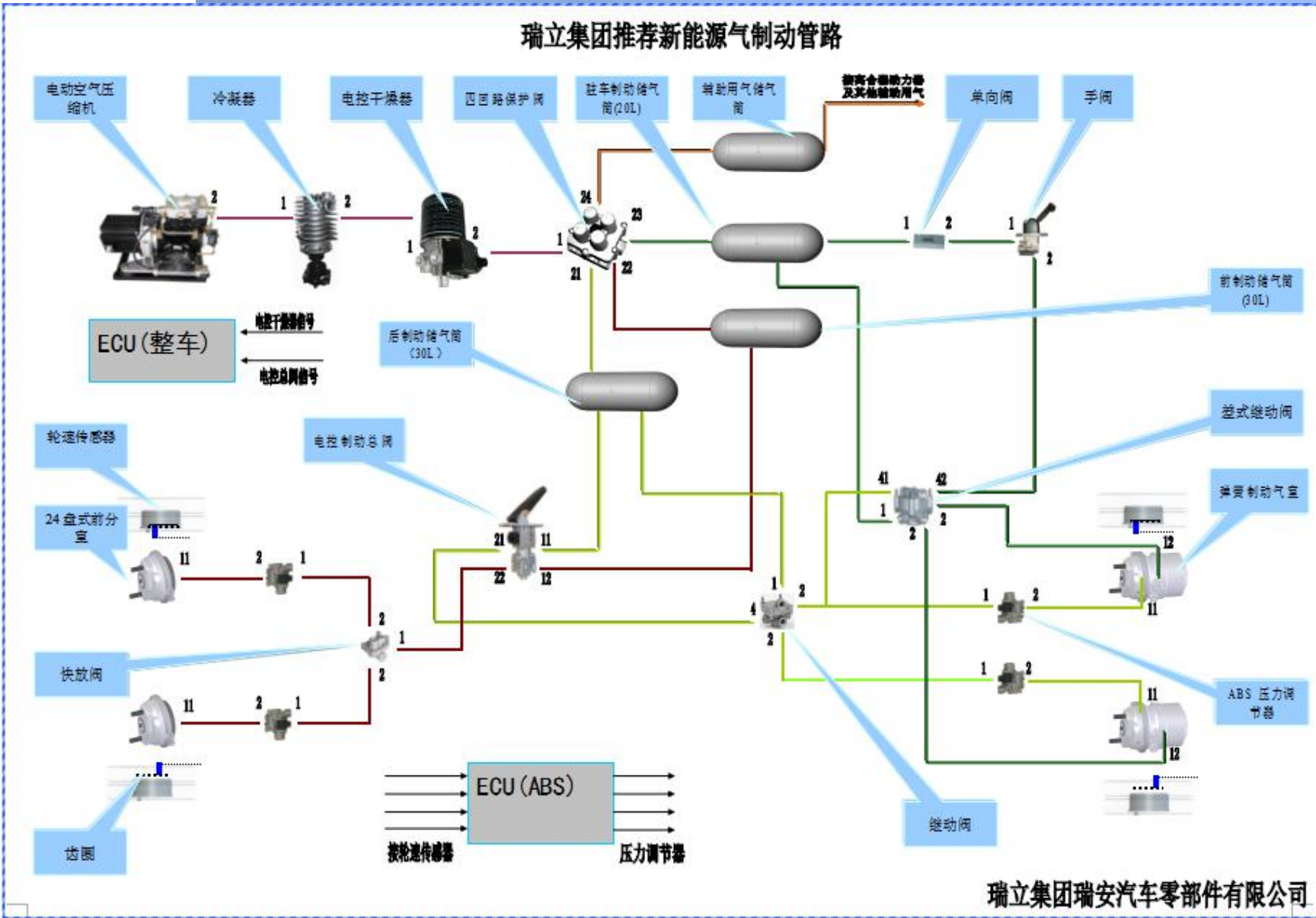

## ➤ **Electric Air Compressors**

- **Lubricated reciprocating air compressors**
- Oil free reciprocating air compressors

## ➤ **Electric Power Steering Pumps**

## ➤ **Electric Water Pumps**



3KW Compressor  
permanent magnet motor



4KW Compressor 3-phase  
asynchronous motor



2.2~3KW Compressor 3-  
phase asynchronous motor

Different types available, with air capacity 170 cm<sup>3</sup>, 240 cm<sup>3</sup>,  
380 cm<sup>3</sup>

## Configuration I

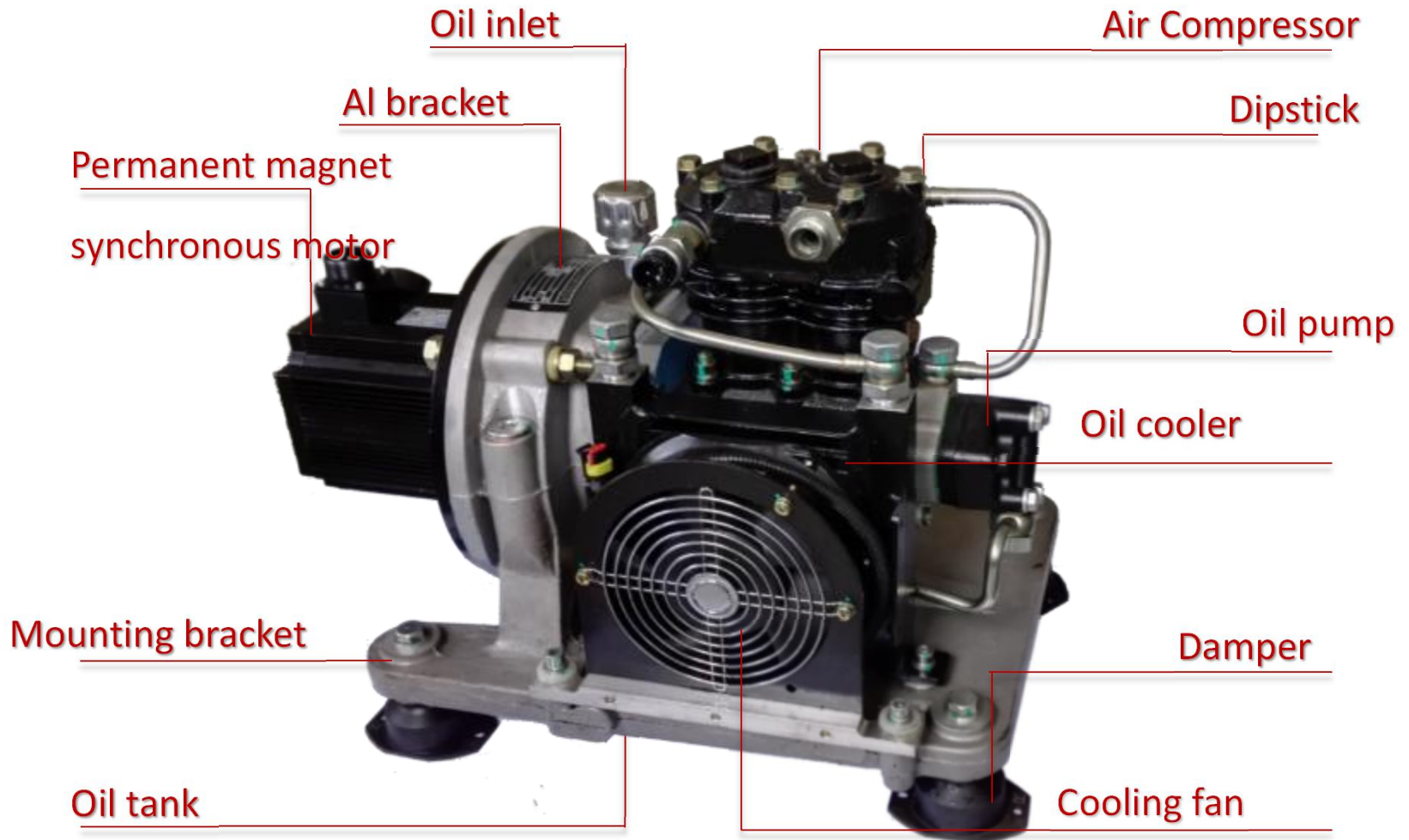



## Configuration I features (permanent magnet)



1. FAD 380 L/min
2. Max delivery pressure 1.0 Mpa
3. Max. delivery temp. <math>< 100^{\circ}\text{C}</math>
4. Noise level  $\leq 72$  dB
5. Allowed working temp.  $-35 \sim 65^{\circ}\text{C}$
6. Weight 76kg
7. Specification of inlet hose with inner dia.  $\varnothing 25$
9. Exhaust connector M22x1.5 Sleeve type
10. Voltage 380V AC/24V DC

### Permanent magnet motor

Rated power : 4KW

Rated current (A) : 7A

Rated frequency (Hz) : 100Hz

Rated voltage(V): Y-type connecting 3\*380V

Pole number : 4

Rated speed : 1500r/min

Insulation grade : H

Protection grade : IP67

## Configuration II (Synchronous) - Features

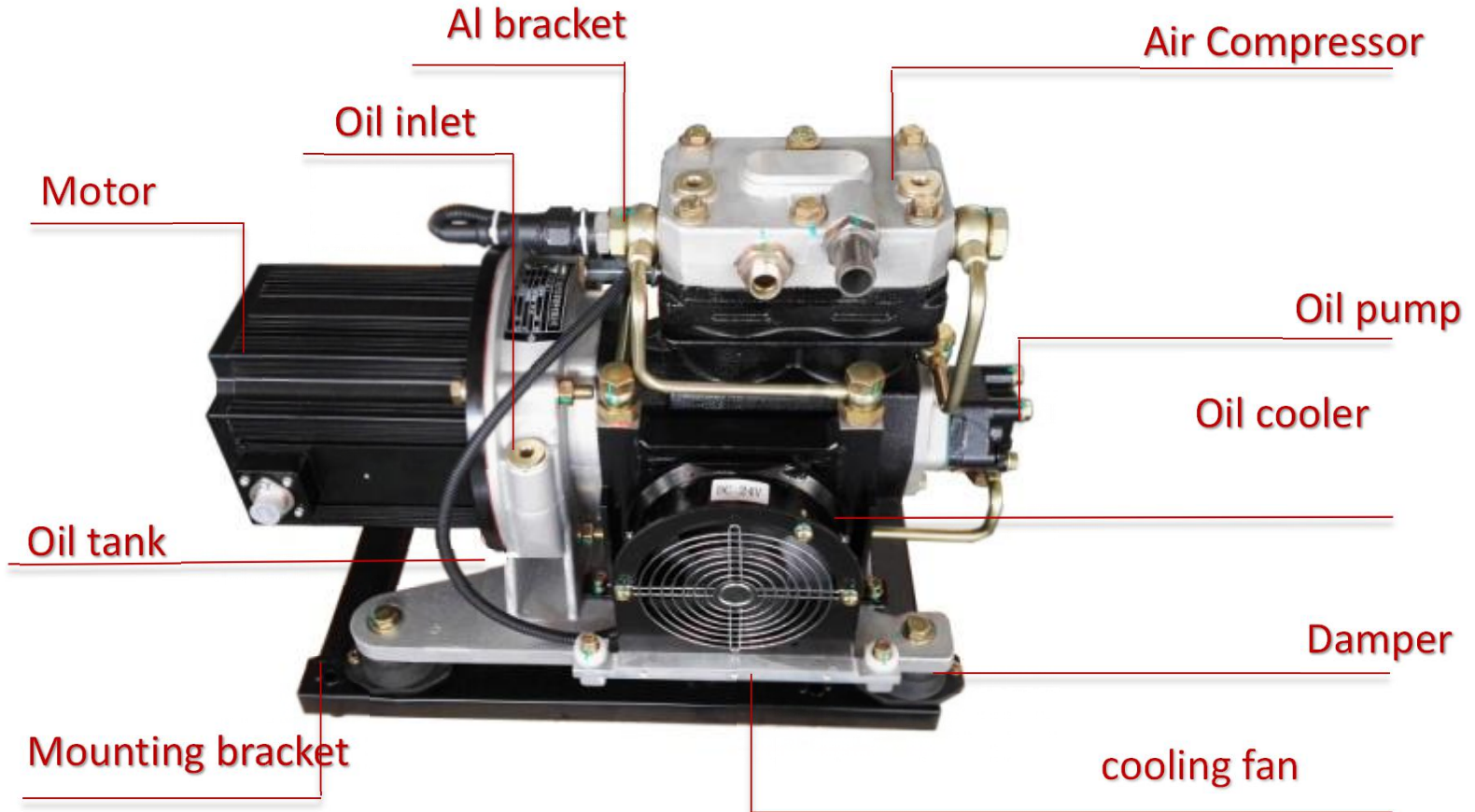

## Configuration II (Synchronous)

- |  |                     |
|--|---------------------|
| 1. FAD   | 380L/min            |
| 2. Max delivery pressure                       | 1.0 Mpa             |
| 3. Max. delivery temp.                         | <100°C              |
| 4. Noise level                                 | 72 dB               |
| 5. Allowed working temp.                       | -35~ 65 °C          |
| 6. Weight                                      | 76kg                |
| 7. Specification of inlet hose with inner dia. | ∅ 25                |
| 9. Exhaust connector                           | M22x1.5 Sleeve type |
| 10. Voltage                                    | 380V AC/24V DC      |



**Permanent magnet synchronous motor**  
 Rated power : 4KW  
 Rated current (A) : 7A  
 Rated frequency (Hz) : 100Hz  
 Rated voltage(V): Y-type connecting 3\*380V  
 Pole number : 4  
 Rated speed : 1500r/min  
 Insulation grade : H  
 Protection grade : IP67

## Configuration II (Synchronous)

1. Capacity 170-240 L/min
2. Max exhausting pressure 1.1Mpa
3. Max. exhausting temp.  $< 90^{\circ}\text{C}$
4. Noise level 72 dB
5. Allowed working temp.  $-35 \sim 65^{\circ}\text{C}$
6. Weight 60kg
7. Specification of inlet hose with inner dia.  $\varnothing 25$
9. Exhaust connector M22x1.5 Sleeve type
10. Voltage 380V AC/24V DC



### Permanent magnet synchronous motor

- Rated power : 2.3KW  
Rated current (A) : 5.3A  
Rated frequency (Hz) : 100Hz  
Rated voltage(V): 380V AC  
Pole number : 4  
Rated speed : 1500r/min  
Insulation grade : H  
Protection grade : IP67

## Installation example

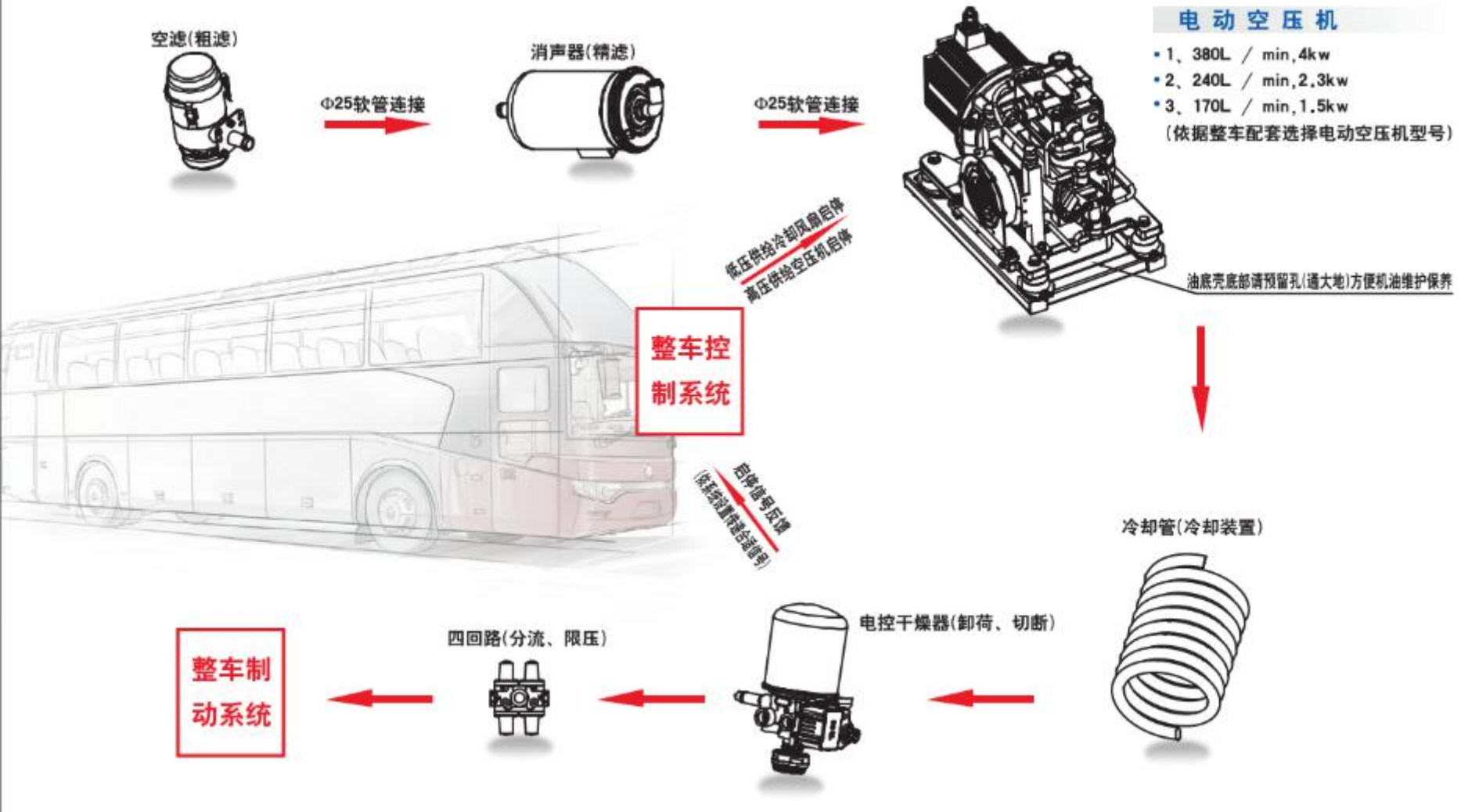

## Control Logic scheme

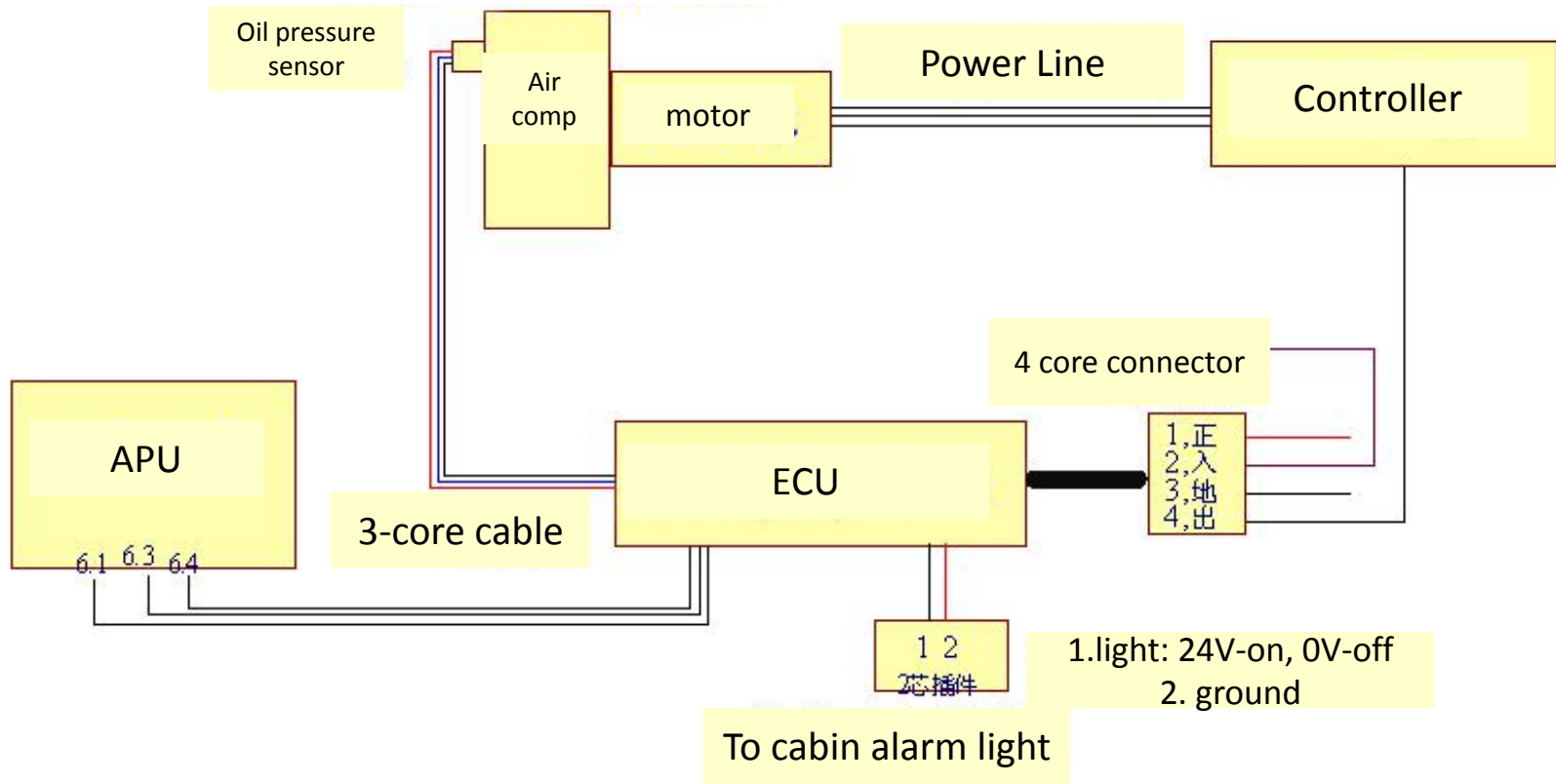

## Advantages

- Long service life: Compressor main body part has the same lifespan as vehicle, having passed 500,000 cycles fatigue test, some field test still on-going, while long time working of rotary vane compressor would cause temperature increase and oil pumping failures.
- Braking security: due to low DAT, the compressor has no risk of blocking braking pipeline due to oil carry over and consequent oil cracking due to high temperature. While screw or scroll types must use emulsifier, high risk of oil carry over generated by emulsion, costs to waste emulsion, and high chances to cause brake parts failures.
- Lower maintenance costs: SORL piston type only needs routine maintenance when up to 30000 kilometers (replacement of filters), no need large-scale maintenance during 3 years warranty period, only need to check individual parts. Rotating machines at 10000 kilometers need a thorough maintenance, perform compulsory maintenance with higher annual maintenance costs.
- Cost: strong manufacturing standardization of SORL compressor, after-sales lower costs, performance/ratio of these units is higher than rotary machines.
- SORL air compressor guarantees energy consumption half of rotary machines of comparable size and FAD.
- SORL as System supplier: providing vehicle braking air system solutions, avoid the waste of electric energy and pressure control logic error

## Comparisons

Item	SORL Reciprocating Type	Screw Rotary Type Oil-less	Screw Rotary Type	Scroll Rotary Type
Type of Lubricant	Standard diesel engine oil	Not needed	Dedicated lubricant	Dedicated lubricant
Lubricant compatibility with sealing	OK	-	Possible poor compatibility with NBR sealing (swelling and aging)	
Oil consumption	Oil Carry Over (limited)	No	Large	Large
Deterioration of lubricant due to emulsification	None	-	Possible	Possible
Oil and gas separator	Not needed	Not needed	Necessary	Necessary
Cost	Low	Very high	High	High



## Comparisons

Item	SORL Reciprocating Type	Screw Rotary Type Oil-less	Screw Rotary Type	Scroll Rotary Type
Delivery pressure (nominal)	8,5 bar	-	-	-
Max. pressure	10 bar	10 bar only if multi-stage	<10 bar	Lower
Electrical wiring	Simple, only three-phase AC		Complex, AC and DC	Complex, AC and DC
Vibration	Due to Piston and Con-Rod reciprocating motion	Balanced	Balanced	Balanced
Noise	Higher SPL	Limited	Limited	Limited
Special maintenance experience required	No	Limited	Required	Required
Maintenance costs in use	Low	Limited	High	High

## Third Party Inspection Report

第 1 页 共 12 页  
Page 1/12

 中国认可  
 中国电子科技集团公司第二十七研究所  
 The 27th Research Institute of China Electronics Technology Group Corporation  
 计量检测中心  
 Metric Inspection Center

### 检测报告

TEST REPORT

报告编号: J300-20160713  
Report No.

---

委托单位: 瑞立集团瑞安汽车零部件有限公司  
*Customer*

地址: 瑞安经济开发区开拓区瑞立工业园  
*Address*

送检产品名称: 电动空压机  
*Item*

型号: 35080108000                      编号: 2016060301020883  
*Type*    *Serial No.*

制造商: 瑞立集团瑞安汽车零部件有限公司  
*Manufacturer*

---

检测人:  <i>Testing performed by</i>	接收日期: 2016年 07月 04日 <i>Date of receipt</i>
检验人:  <i>Report inspected by</i>	检测日期: 2016年 07月 14日 <i>Date of issue</i>
批准人:  <i>Written approval of</i>	检测单位 (专用章) <i>Issued by (Stamp)</i>



地址 (Addr.): 河南省郑州市郑东新区博学路 36 号  
 电话 (Tel.): 0371-61270918 传真 (Fax): 0371-61270931 邮编 (Post Code): 450047  
 电子邮箱 (E-mail):

Vibration test, salt spray test, waterproof test, dust proof test, insulation and noise intensity test are included.

## Third Party EMC Test Report



## EMC 检测报告

**Nanjing RongCe Testing  
Technology Ltd.**

报告编号: CDSJ160101502      2016/1/18  
发布日期

委托方: 瑞立集团瑞安汽车零部件有限公司

委托方地址: 浙江省瑞安市经济开发区八十亩 瑞立集团

样品名称: 油压监控 ECU

型号: 3509 D10

编制: 林龙伟      审核: 陈凯      签发: 沈学其

林龙伟 (工程师)      陈凯 (技术负责人)      沈学其 (主任)



**南京容测检测技术有限公司**  
Nanjing RongCe Testing Technology Ltd.

## Water-protection Test

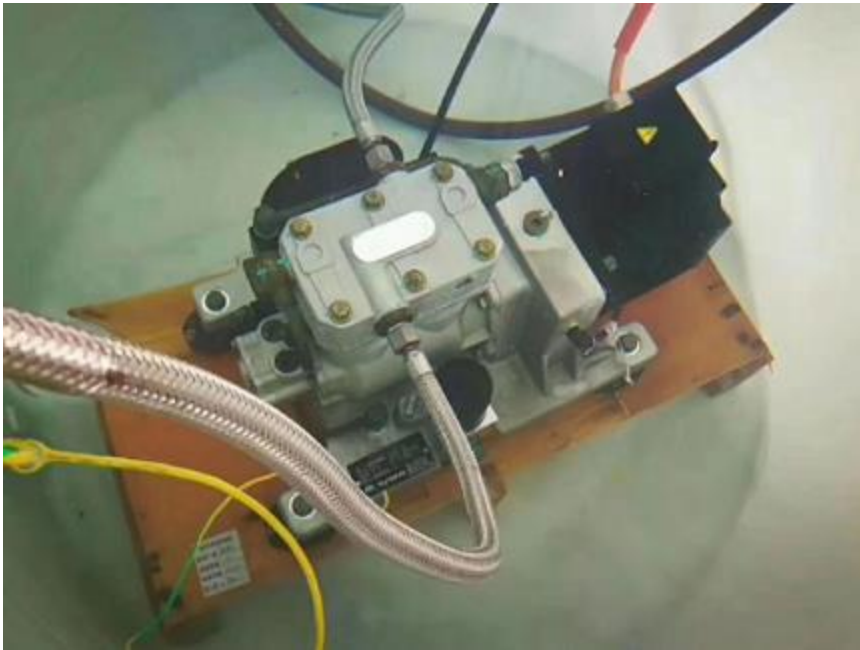

The electric air compressor passed GB 4208-2008/IEC 60529-2001 “shell protection grade (IP68 grade)” (diving 24 h underwater with normal operation)

## Patents

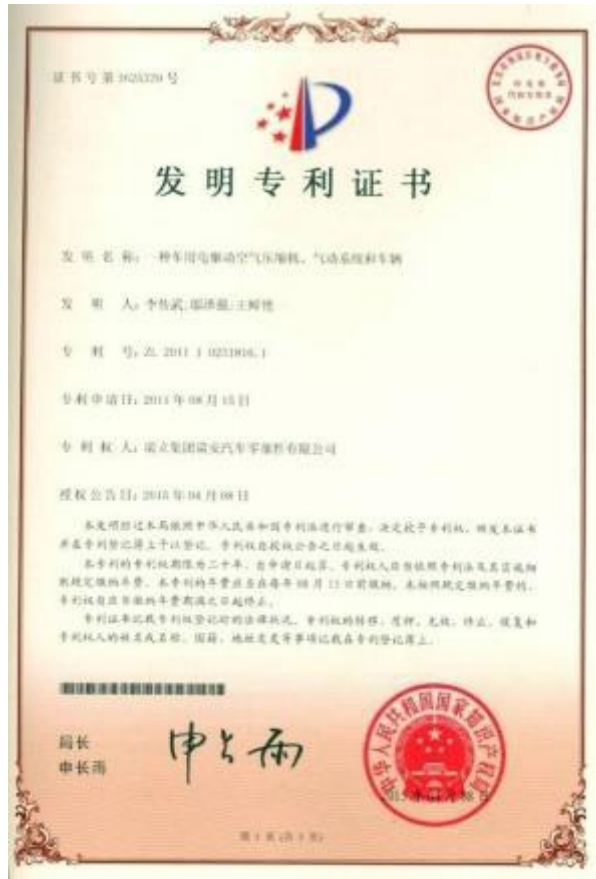

## OEM Customers

SORL is OEM supplier for Yutong,, Zhongtong Bus, Xiamen Kinglong, Golden Dragon, Yaxing Coach, Shanghai Shenlong, Suzhou Kinglong, Ankai Bus, Chongqing Hengtong Bus, Jinhua YoungMan, etc. In international market, we supplier to SEA, Mahindra, EDI, Emoss etc.

Besides this, SORL also provides OEM services to city bus in Shenzhen, Guangzhou, Tianjin, Shanghai, Wuhan, Dalian, Jinan, Suzhou, Chongqing, Changsha, Xi'an, Huizhou, Qingdao, Baoding etc dozens of cities.



## Applications

SORL electric air compressors are mainly used for pure electric/hybrid electric vehicles.

And in electric air compressors, SORL is not only OEM supplier for almost all China brand bus manufacturers, but also plays an important role in providing OEM service for Chinese social activities, such as Beijing Olympics city bus in 2008, 60<sup>th</sup> National Holiday Anniversary of military parades, Shanghai Expo in 2010, Guangzhou Asia Games, Shanghai Disney Resort in 2016 and new energy buses. During these events all the Buses for public transport were equipped with SORL Electric Air Compressors.



## Applications Yutong Buses



Yutong Bus mainly located in Guangdong, Henan, Jiangsu, Zhejiang, Hebei, Inner Mongolia, Qinghai, Shanghai and so on, covering almost all over the China







## Applications Zhongtong Buses



## Applications BYD Buses

BYD Buses with SORL electric air compressor mainly located in Tianjin, Shenzhen, Guangzhou, Baotou and Chengde.



## Applications Shanghai Sunwin



## Sales Volume

- First study started in 2008
- Series development started officially on 2010
- SOP on December 2012
- Sales increased significantly in 2015.

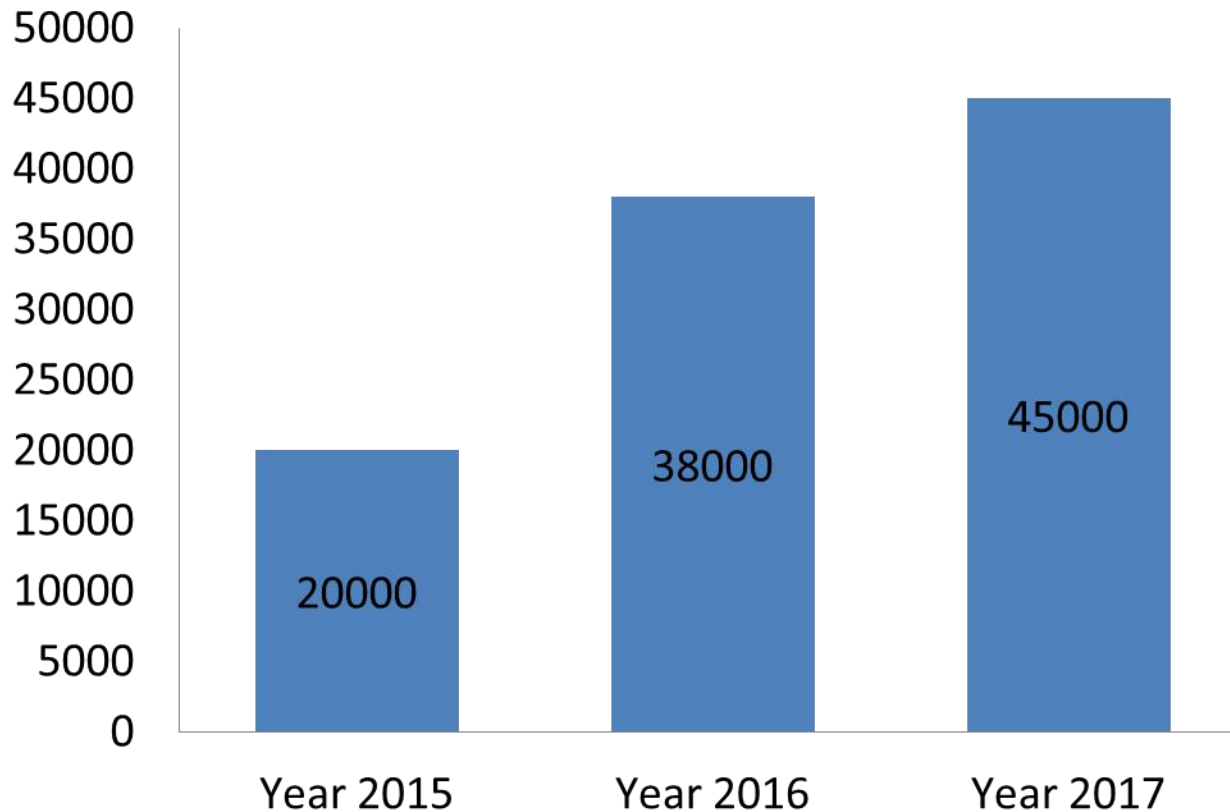

## ➤ **Electric Air Compressors**

- Oil reciprocating air compressors
- **Oil free reciprocating air compressors**

## ➤ **Electric Power Steering Pumps**

## Contents

- Product Range
- SORL Product Comparison and Customer Concerns
- Validation Tests

# Oil-free reciprocating Air Compressors



Several types available, with capacity 66 L/min, 120 L/min, 240 L/min, 380 L/min. (2-stages type)

## Configurations

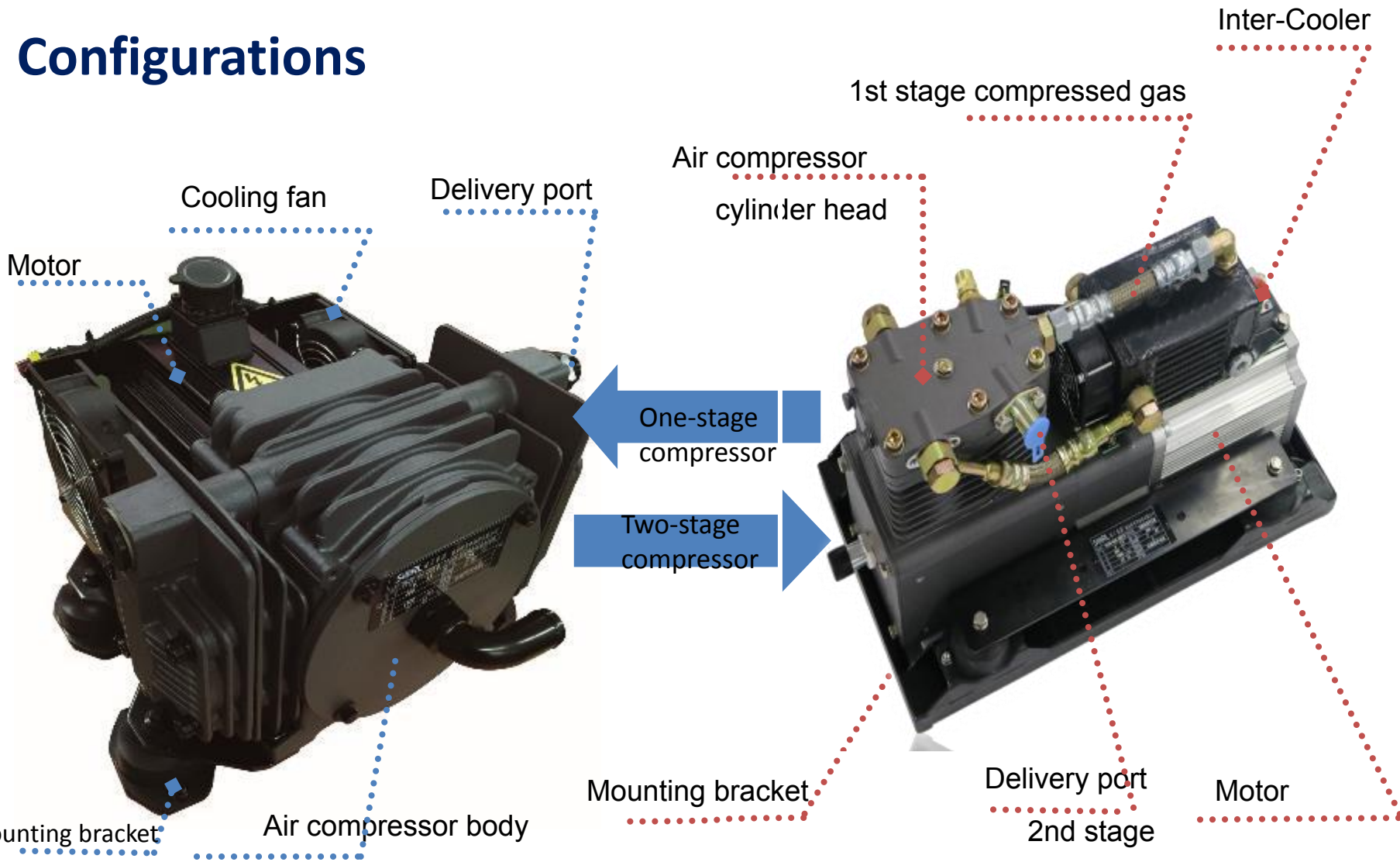



## Technical Features – type 1



Oil free single stage, single cylinder

Suitable for light truck, urban logistics vehicles.

Cylinder bore	Φ70mm Single cylinder	Motor Power	0.85KW
Stroke	22mm	Dimensions	285x253x219
Working volume	85 cm <sup>3</sup>	weight	15Kg
Rated discharge pressure	0.85 MPa	Operating temperature	-40°C~ +60°C
Rated air capacity	60 L/min	Noise	≤72dB(A)

## Technical Features - type 2

Suitable for mini bus with length less than 6m, light truck, logistics vehicle

Cylinder bore	Φ70mm twin-cylinder	Motor Power	1.5KW
Stroke	22mm	Dimensions	350x355x265
Swept volume	169 cm <sup>3</sup>	Weight	25Kg
Rated discharge pressure	0.85 MPa	Operating temperature	-40°C~+60°C
Rated air capacity	110 L/min	Noise	≤72dB(A)



Oil-free single stage, twin-cylinder

## Technical Features - type 3



**Oil-free two-stage twin cylinder electric air compressor**

**Suitable for mini bus with length less than 9 m, light truck, logistics vehicles.**

Rated air capacity	240L/m in	Motor Power	3KW
Rated discharge pressure	1Mpa	weight	48Kg
Max . delivery pressure	1.2Mpa	Noise	≤72dB(A)
Dimensions	500x28 5x320m m	Protection level	IP67

## Technical Features - type 4

Suitable for mini bus with length less than 9 m, light truck, logistics vehicles

Rated air capacity	380L/min	Motor Power	4KW
Rated discharge pressure	1Mpa	weight	65Kg
Max . exhaust pressure	1.2Mpa	Working temperature	-40°C~ +60°C
Dimensions	560x335x370mm	Noise	≤72dB(A)

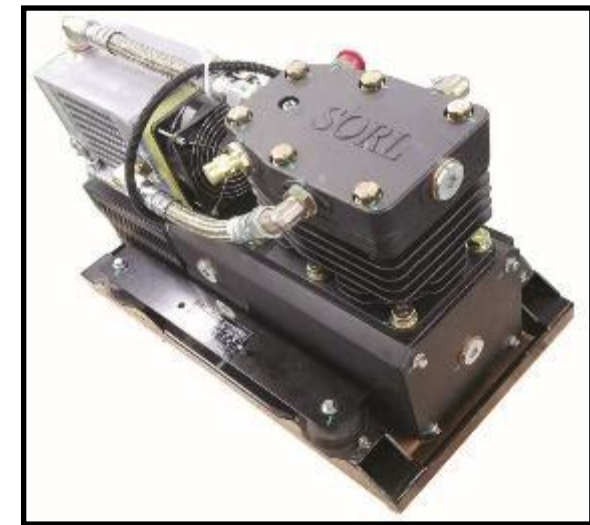

**Oil-free two-stage twin cylinder electric air compressor**

## Advantages

Self-lubricating material, no oil carry-over, no pollution

Two-stage compression of high efficiency, low energy consumption and strong reliability

Low noise, fully meet the needs of users

Compact structure, convenient installation (no lubricant circuit and filter) and convenient chassis layout

Shock absorber implemented, smooth operation, small vibration

IP67 class dustproof, waterproof

Total oil - free design, simple maintenance, low cost

Wide scope of application and strong versatility

## Comparisons

Items	Ruili oil-free piston air compressor	Screw type air compressor	Vane type	
Lubricant type	No lubricant	Special screw oil	Special rotary vane oil	
Lubricating oil consumption		large	large	
Lubricant emulsification deterioration degree		easy	easy	
Lubricant environment adaptability		Easy to be polluted	Easy to be polluted	
Oil/air separator		Must use and have a short life	Must use and have a short life	
Lubricant temperature control		Necessary	Necessary	
Lubricants impact on vehicle safety			If the maintenance is not timely, the braking system will be polluted, will cause the rubber parts to swell and deteriorate, which will easily cause the braking system to fail	

# Oil-free reciprocating Air Compressors

<b>Comparisons</b>	<b>SORL oil-free piston air compressor</b>	<b>Oil-free scroll air compressor of competitors</b>
Delivery pressure	The rated discharge pressure can be reached regardless of capacity; New national standard in 2017 requires > 1MPa delivery pressure	Due to the limitations of working chamber seals and component strength conditions, resulting in low exhaust pressure, it is impossible to reach 1mpa for a long time.
Structural seal	Straight connection between motor and pump head, simple structure; simple and reliable sealing method	Request sever sealing condition as the moving parts need to maintain a certain movement gap to achieve sealing, which is complex sealing structures, result in leakage easily if no good .
Environmental adaptability	Strong environmental adaptability, even normal operation in poor environments (low temperature, high temperature, high altitude, etc.)	The moving parts are mostly curved surfaces, and the processing requirements of the curved surfaces are relatively high. The upper and lower end surfaces of the movable and stationary disks require high sealing, resulting in high requirements on the environment.
Machine cooling	The whole machine adopts air-cooled/air-cooled+cooler combination, which has better cooling effect	Due to the fact that its internal working chamber cannot be externally cooled, its internal heat is difficult to be extracted, resulting in high requirements for heat dissipation.
Maintenance	Easy maintenance, no special requirements for the maintenance of air compressors	High requirements on the seal, leading to the need for regular maintenance of the seal by disassemble the air pump
Service life	Due to its strong environmental adaptability, it has a long service life	Due to its structural seal effect, its service life is greater than its environmental impact <b>39</b>

# Oil-free reciprocating Air Compressors

## Comparisons

	Ruili oil-free piston air compressor 2-stage)	Screw type air compressor	Vane type
Compression efficiency	High	General	High
Space needed	Small	General	Small
Weight	Light	Light	Light
Energy consumption	normal	General	High
Protection level	IP67	IP56	IP56
Operating temperature	-40°C ~+60°C	-50°C ~+50°C	-25°C ~+45°C
Noise	General	General	Small
Air quality	Good	Compressed air quality is poor, with high gas discharge	
Service life	Long	General	Short
Maintenance experience	No special maintenance experience required	High maintenance experience required	
Maintenance cost	Low	High	High



## Validation Tests

Power consumption test; Specific power test;

Durability test; Vibration endurance test;

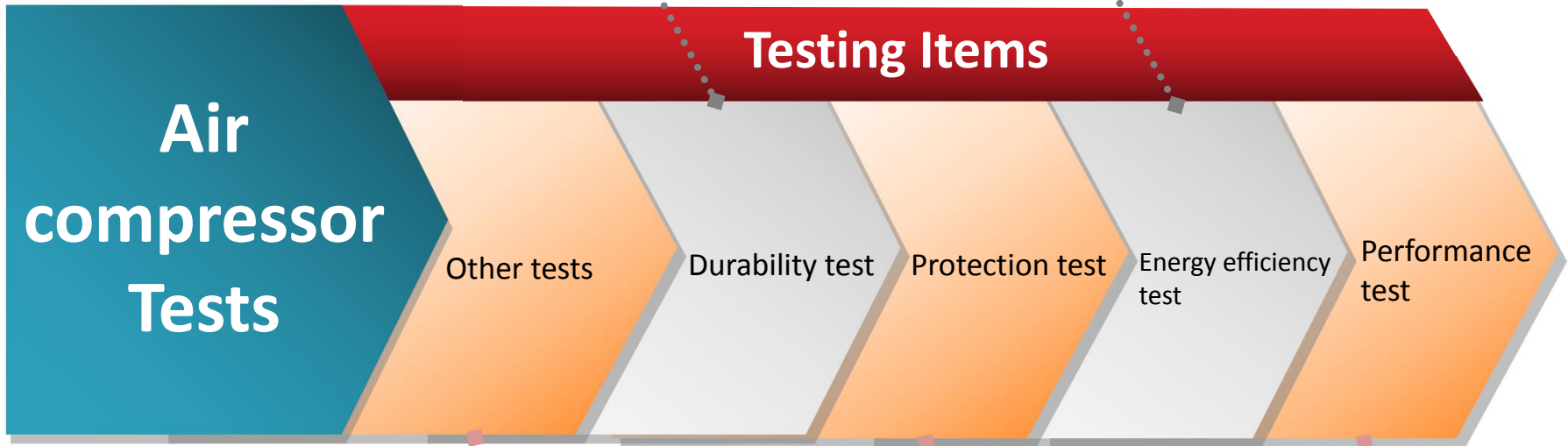

Leakage test; cleanliness test;

IP67 waterproof and dustproof test; corrosion resistance test;

Air capacity test; volumetric efficiency test; high/low temperature test; noise test; DAT measurement.

## Applications



FAW Liberation Tiger V



7.2 m new energy bus



Karry new energy truck



Altria light truck



Dongfeng light truck



11m passenger car



10.5 m / 12m  
pure electric  
new energy bus



## ➤ **Electronic Air Compressors**

- Oil reciprocating air compressors
- Oil free reciprocating air compressors

## ➤ **Electric Power Steering Pumps**

## Contents

- Applications
- Product Range
- Advantages

## Applications

In electric Power Steering Pumps, SORL is OEM supplier for Shenzhen Wuzhoulong Motors, Yantai Shuchi Bus, Zhengzhou Yutong, Zhuhai GT Bus, GAC Group, Jinhua YoungMan, Anhui ANKAI, Chongqing Wuzhoulong Motors, Chongqing Hengtong, Yuchai Group, Shaolin Bus etc.



## Applications

S No.	Customer	Vehicles	Motor Power
1	Shenzhen Wuzhoulong Motors	City bus, branch bus	4KW, 3KW, 2.2KW, 1.5KW
2	Yantai Shuchi Bus	City bus	3KW
3	Zhengzhou Yutong	City bus	3KW
4	Zhuhai GT Bus	Two-layer bus	4KW, 3KW
5	GAC Group	City bus	3KW, 2.2KW
6	Jinhua YoungMan	City bus	4KW, 3KW
7	Anhui ANKAI	City bus	4KW, 1.5KW
8	Chongqing Wuzhoulong Motors	City bus	4KW, 3KW, 2.2KW
9	Chongqing Hengtong	City bus	3KW(permanent magnet synchronous )
10	Shaolin Bus	City bus	3KW, 2.2KW
11	Yuchai Group	City bus	3KW(permanent magnet synchronous)

## Applications

Development officially started in 2010, electric power steering pump got first OEM order in 2012.

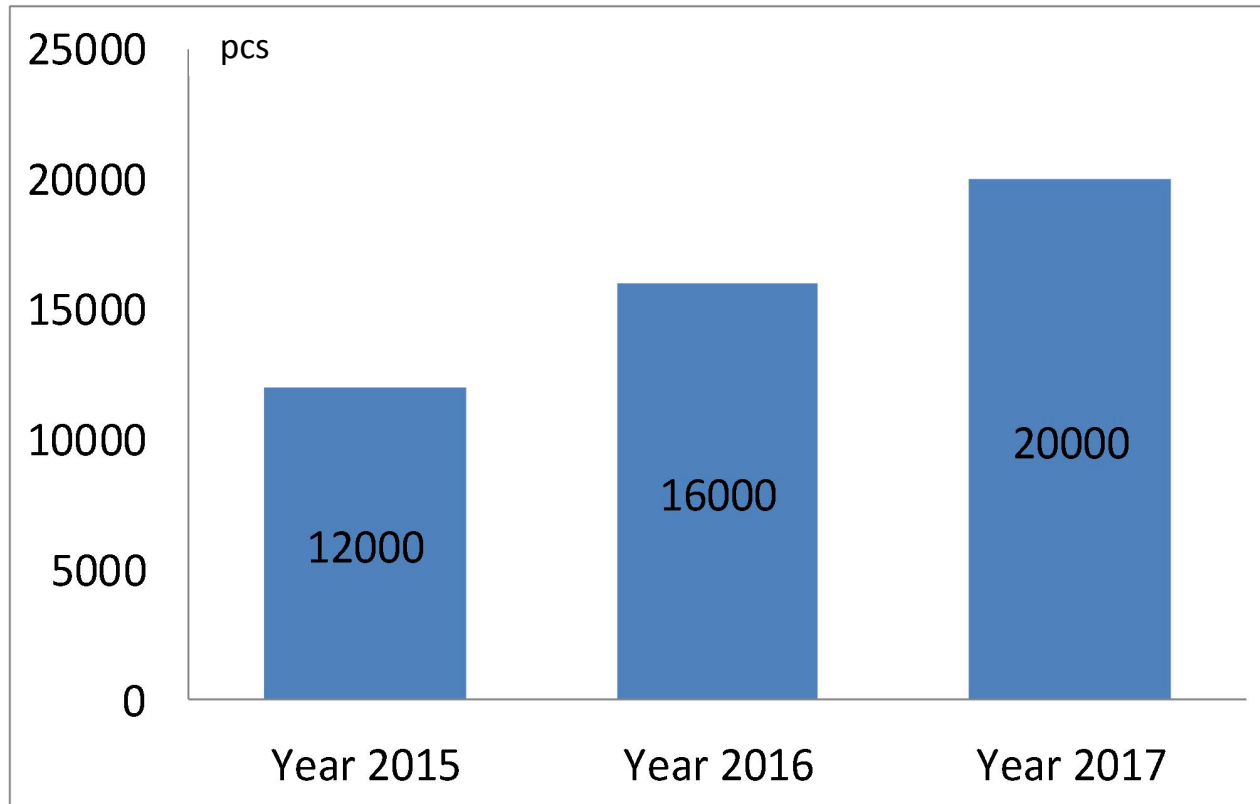

## Types

More than 30 products variants. Several motors available (4KW, 3KW, 2.2KW, 1.5KW etc.); types are three-phase asynchronous, variable frequency adjustable speed three-phase asynchronous, DC brushless, permanent-magnet synchronous motor.



4KW Electric PSP



3KW Electric PSP  
permanent magnet synchronous motor



2.2KW Electric PSP



## Types

- Electric PSP adopts squirrel-cage three-phase asynchronous motor, with advantages of good performance, simple structure, high reliability, strong overload capability, small current, low energy consumption.
- Motor directly connected to the oil pump, this lead to high transmission efficiency, compact structure, secure and reliable installation.
- Oil pump and motor outside shell are made of high strength Al alloy, this decreases weight and ensures robustness.
- 100% noise test at end of line testing with high standards (noise shall be less than 72dBA in empty load, SPL measured at 150 mm distance from product).
- Motor rotating speed can be read through vehicle CAN wire, and controlled by steering wheel or ECU current, this can increase oil pump output flow. When steering servo-assistance is not needed the ECU would lower the speed to idle, thus decreasing energy consumption.

## ➤ **Electronic Air Compressors**

- Oil reciprocating air compressors
- Oil free reciprocating air compressors

## ➤ **Electric Power Steering Pumps**

## ➤ **Electric Water Pumps**

- Development History
- Customers
- Product Range
- Advantages vs. Competitors
- Test Details

## Development History

Ruili studied Electronic Water Pump since 2016:

- 1) Determined product performance and test STDs.
- 2) Independently developed Hall plate and drive plate of EWP.
- 3) Buy EWP performance test bench.
- 4) Sampling and test since 2017.

## Customers



## Product Range



## Advantages

1. Compact structure, easy installation, reliable performance;
2. Low noise, high efficiency;
3. High efficiency brushless DC motor drive, low thermal power, motor efficiency up to 90%, longer life;
4. Pump locked-rotor protection: EWP would stop when stuck i.e. by alien particles, and would run when removed;
5. Reverse connection protection: protect reverse connection of pins;
6. Pump dry run protection;
7. Overvoltage, undervoltage, overcurrent, undercurrent protection;

## Reliability Test



Test Chamber

### Test Standard

- Test voltage:  $27 \pm 0.5V$  DC
- Medium temp:  $90^{\circ}$  C
- Test time:  $> 2000$  hrs



## Vibration Test



Vibration test bench

### Test standard: GB/T 28046.3-2011

- Test acceleration (PSD);
- Vibration type: random;
- Test time: 96h, includes vertical vibration 32h, horizontal vibration 32h, longitudinal vibration 32h;
- Test temp: ambient

## Endurance Vibration Test



Test tank Vibration tooling

Test standard:

- Mount pump on special vibration equipment, water inlet from suction cup every 5S, 10S drop for free vibration, 15S/cycle, 3000 cycles/day, continuous load (in operating point state) operation
- Medium temp: ambient
- Ambient hum: often wet
- Test voltage: 24V DC
- Test time: 2000 hrs

## Under-Voltage Operation Test



Test bench

Test standard:

- Test voltage: 18V DC
- Medium temp: 60° C
- Test time: >100 hrs

## Over-Voltage Operation Test



Test standard:

- Test voltage: 32V DC
- Medium temp: ambient
- Ambient hum: often wet
- Test time: > 100 hrs

Life test tank DC regulated power

## On-Off Life Test



DC Power Test Tank

Test standard:

- Test voltage: 24V DC
- Medium temp: ambient
- Ambient hum: often wet
- Cycle: 1min ON,10S OFF
- Test period: 300.000 cycles

## Noise Test



Microphone Acceleration Sensor

### Test standard:

- Test method: Sound level meter microphone installed at a 45 ° angle above pump, 1.0m from pump center, distance less than 1.0 m between center of microphone and wall, ground, roof to reduce impact of reflection; background noise during test should be 10dB lower than noise of device under test; begin test after motor stable running (current stable, no significant abnormal noise).
- Test requirements:  $\leq 61\text{dB(A)}$

## IP68 Protection Test

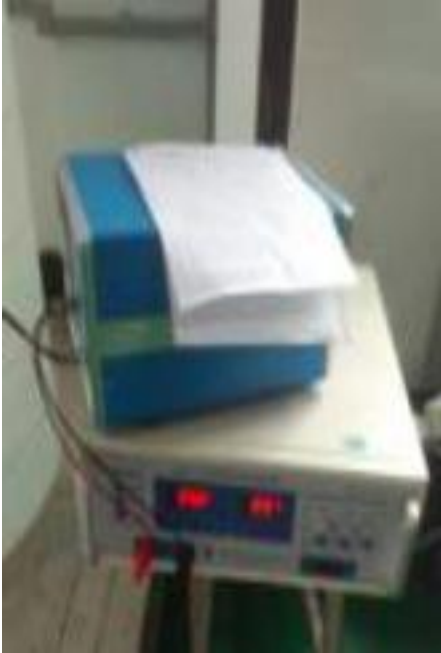

### Test standard:

- Test voltage: 24V DC
- Test STD: GB/T4942.1-2001
- Test depth: 1 m below water level
- Test time: 1000 hrs

DC Power Cistern Height 1.2m

## High Temperature Test



### Test standard:

- Test temp: +125°C
- Test requirements: Pump running, test results meet characteristic requirements after 94h high temp and 2h ambient temp

High Temperature Box



## Low Temperature Test



DC Power

### Test standard:

- Test temp:  $-50^{\circ}\text{C}$
- Test requirements: 8h low temperature, then 2h normal operation with  $85 \pm 5^{\circ}\text{C}$  hot water, able to work after 50 cycles

## Anti-dry Characteristics Test

Motor of EWP runs normally within 15 min no-load power (DC24V), stops running and starts self-protection after 15 min.

THANK YOU!



## **RUILI GROUP CHINA**

No. 2666, KaiFaqu Avenue, Ruian  
Economic Development Zone,

Zhejiang, 325200, China

Tel: +86-577-6500 8000

E-mail: [info@sorl.com.cn](mailto:info@sorl.com.cn)

<http://www.sorl.cn>