

COUPLING CATALOGUE

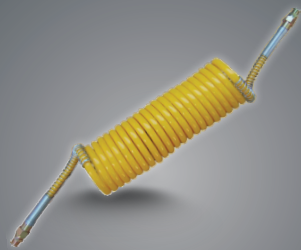

Tubes & Cables & Fittings



Headquarters

SORL Auto Parts, Inc.

No.2666, KaiFaqu Avenue, Ruian Economic Development Zone, Zhejiang Province, 325200, China
Tel: 0086-577-6500 8000, 6560 9583
Fax: 0086-577-6592 2008
E-mail: info@sorl.com.cn
<http://www.sorl.com.cn>

Local distributor



Overseas branches

Global SORL Auto & Truck Parts Inc. (USA)

1200 E. Gene Autry Way
Anaheim CA 92805
Tel: 001-714-634 1888
Fax: 001-714-634 1886
E-mail: mike@globalsorl.com

Golden Dragon Auto Spare Parts (Dubai)

P.O. Box 56306, Dubai, U.A.E.
Tel: 00971-4-2278556
Fax: 00971-4-2278552
E-mail: sorl@emirate.net.ae

SORL International Holding Ltd. (HongKong)

Unit 06,19/F, Laurels Industrial Centre, No. 32
Tai Yau Street, San Po Kong, Kowloon, HK
Tel: 00852-3188 4246, 3188 4247
Fax: 00852-3188 4248
E-mail: info@sorl.com.cn

SORL Bulgaria Ltd. (Bulgaria)

West Industrial zone
Ex brewery factory
9000 Varna, Bulgaria
Tel: 0035-9899 193801
E-mail: g.petrov@sorl-europe.bg





Straight Tubes 1

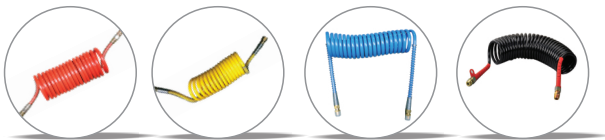

Coiled Tubes 3



Electric Cables 8



Standard Connectors 9



Quick Connectors 14



Nylon Air Brake Tubing PA 6/12/11, 25/50/100m,



Straight tubes

Application: only for auxiliary circuits, Standard: DIN 73378, Dot Certification AXL15

SORL #	∅ t	↔ l [m]	Colour	Material
081 000 31BK	1/8	25	Black	PA12
163 000 31BK	3/16	25	Black	PA12
041 000 31BK	1/4	25	Black	PA12
165 000 31BK	5/16	25	Black	PA12
083 000 31BK	3/8	25	Black	PA12
D083 000 31BK	3/8	25	Black	PA12(Double)
021 000 31BK	1/2	25	Black	PA12
D021 000 31BK	1/2	25	Black	PA12(Double)
085 000 31BK	5/8	25	Black	PA12
D085 000 31BK	5/8	25	Black	PA12(Double)
043 000 31BK	3/4	25	Black	PA12
D043 000 31BK	3/4	25	Black	PA12(Double)
004 100 31BK	4x1	25	Black	PA12
005 100 31BK	5x1	25	Black	PA12
006 100 31BK	6x1	25	Black	PA12
008 100 31BK	8x1	25	Black	PA12
D008 125 31BK	8x1.25	25	Black	PA12(Double)
D008 150 31BK	8x1.5	25	Black	PA12(Double)
009 150 31BK	9x1.5	25	Black	PA12
D009 150 31BK	9x1.5	25	Black	PA12(Double)
010 100 31BK	10x1	25	Black	PA12
010 125 31BK	10x1.25	25	Black	PA12



Nylon Air Brake Tubing PA 6/12/11, 25/50/100m,



Straight tubes



Application: only for auxiliary circuits, Standard: DIN 73378, Dot Certification AXL15

SORL #	∅ t	↔ l [m]	Colour	Material
D010 125 31BK	10x1.25	25	Black	PA12(Double)
010 150 31BK	10x1.5	25	Black	PA12
D010 150 31BK	10x1.5	25	Black	PA12(Double)
011 150 31BK	11x1.5	25	Black	PA12
D011 150 31BK	11x1.5	25	Black	PA12(Double)
012 150 31BK	12x1.5	25	Black	PA12
D012 150 31BK	12x1.5	25	Black	PA12(Double)
014 150 31BK	14x1.5	25	Black	PA12
D014 150 31BK	14x1.5	25	Black	PA12(Double)
015 150 31BK	15x1.5	25	Black	PA12
D015 150 31BK	15x1.5	25	Black	PA12(Double)
015 200 31BK	15x2	25	Black	PA12
D015 200 31BK	15x2	25	Black	PA12(Double)
016 200 31BK	16x2	25	Black	PA12
D016 200 31BK	16x2	25	Black	PA12(Double)
018 200 31BK	18x2	25	Black	PA12
D018 200 31BK	18x2	25	Black	PA12(Double)

Coiled tubes

Application: air braking systems, Standard: ISO 7375, $\varnothing 12$ , $\varnothing 100$ 





SORL #	 Thread	Coils	Colour	Material
RLD5-F027A	 NPT1/2	16	Yellow	PA12
RLD5-F027DM16	 M16x1.5	16	Yellow	PA12(Double)

Coiled tubes

Application: air braking systems, Standard: ISO 7375, $\varnothing 12$ , $\varnothing 100$ 





SORL #	 Thread	Coils	Colour	Material
RLD5-F012	 M22x1.5	17	Red	PA12
RLD5-F013	 M22x1.5	17	Yellow	PA12

Coiled tubes

Application: air braking systems, Standard: ISO 7375, $\varnothing 12$ , $\varnothing 100$ 









SORL #	 Thread	Coils	Colour	Material
RLD5-F028M16	 M16x1.5	18	Red	PA12
RLD5-F028DM22	 M22x1.5	18	Yellow	PA12(Double)

Coiled tubes

Application: air braking systems, Standard: ISO 7375, $\varnothing 12$ , $\varnothing 100$ 









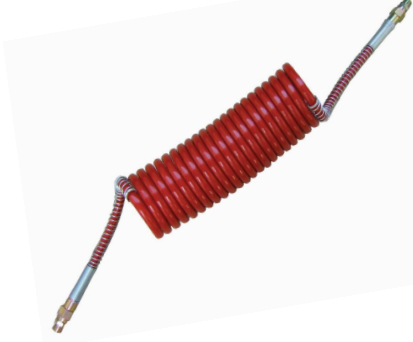



SORL #	 Thread	Coils	Colour	Material
RLD5-F017	 M16x1.5	20	Yellow	PA12
RLD5-F017A	 NPT1/2	20	Red	PA12
RLD5-F017B	 M16x1.5	20	Blue	PA12
RLD5-F019	 M22x1.5	20	Black	PA12
RLD5-F019A	 M22x1.5	20	Black	PU
RLD5-F029C	 NPT1/2	20	Red	PA12(Double)

Coiled tubes

Application: air braking systems, Standard: ISO 7375, $\varnothing 12$ , $\varnothing 100$ 







SORL #	 Thread	Coils	Colour	Material
RLD5-F006	 M16x1.5	22	Blue	PA12
RLD5-F007	 M16x1.5	22	Red	PA12
RLD5-F007A	 NPT1/2	22	Red	PA12
RLD5-F007B	 M22x1.5	22	Red	PA12
RLD5-F007H	 NPT3/8	22	Red	PA12
RLD5-F008	 M16x1.5	22	Yellow	PA12
RLD5-F008A	 NPT1/2	22	Yellow	PA12
RLD5-F008B	 M22x1.5	22	Yellow	PA12
RLD5-F030C	 NPT1/2	22	Red	PA12(Double)

Coiled tubes

Application: air braking systems, Standard: ISO 7375, $\varnothing 12$ , $\varnothing 100$ 







SORL #	 Thread	Coils	Colour	Material
RLD5-F031	 NPT1/2	24	Red	PA12
RLD5-F031AM22	 M22x1.5	24	Yellow	PA12
RLD5-F031C	 NPT1/2	24	Red	PA12(Double)

Coiled tubes

Application: air braking systems, Standard: ISO 7375, $\varnothing 12$ , $\varnothing 100$ 







SORL #	 Thread	Coils	Colour	Material
RLD5-F032	 NPT1/2	26	Red	PA12
RLD5-F032AM22	 M22x1.5	26	Yellow	PA12
RLD5-F032CM16	 M16x1.5	26	Red	PA12(Double)

Coiled tubes

Application: air braking systems, Standard: ISO 7375, $\varnothing 12$ , $\varnothing 100$ 







SORL #	 Thread	Coils	Colour	Material
RLD5-F033	 NPT1/2	28	Red	PA12
RLD5-F033AM22	 M22x1.5	28	Yellow	PA12
RLD5-F033CM16	 M16x1.5	28	Red	PA12(Double)

Coiled tubes

Application: air braking systems, Standard: ISO 7375, $\varnothing 12$ , $\varnothing 100$ 







SORL #	 Thread	Coils	Colour	Material
RLD5-F034C	 M16x1.5	25	Black	PA12
RLD5-F034D	 M18x1.5	22	Black	PA12
RLD5-F034B	 M22x1.5	25	Black	PA12

Coiled tubes

Application: air braking systems, Standard: ISO 7375, $\varnothing 12$ , $\varnothing 100$ 



SORL #	 Thread	Coils	Colour	Material
RLD5-F034F	 M16x1.5	25	Black	PA12
RLD5-F034G	 M18x1.5	22	Black	PA12
RLD5-F034E	 M22x1.5	25	Black	PA12

Coiled tubes

 Application: air braking systems, Standard: ISO 7375, $\varnothing 12$, $\varnothing 100$

SORL #	Thread	Coils	Colour	Material
RLD5-F020A	NPT1/2	16	Blue	PA12
RLD5-F020BM22	M22x1.5	16	Red	PA12(Double)
RLD5-F020DM16	M16x1.5 Copper	16	Red	PA12(Double)

Coiled tubes

 Application: air braking systems, Standard: ISO 7375, $\varnothing 12$, $\varnothing 100$

SORL #	Thread	Coils	Colour	Material
RLD5-F021	NPT1/2	18	Red	Pa12
RLD5-F021AM22	M22x1.5	18	Blue	PA12
RLD5-F021DM16	M16x1.5 Copper	18	Red	PA12(Double)

Coiled tubes

 Application: air braking systems, Standard: ISO 7375, $\varnothing 12$, $\varnothing 100$

SORL #	Thread	Coils	Colour	Material
RLD5-F022	NPT1/2	20	Red	PA12
RLD5-F022BM22	M22x1.5	20	Red	PA12(Double)
RLD5-F022EM16	M16x1.5 Copper	20	Blue	PA12(Double)

Coiled tubes





 Application: air braking systems, Standard: ISO 7375, $\varnothing 12$, $\varnothing 100$

SORL #	Thread	Coils	Colour	Material
RLD5-F023M16	M16x1.5	22	Red	PA12
RLD5-F006DM22	M22x1.5	22	Blue	PA12(Double)
RLD5-F007D	NPT1/2 Copper	22	Red	PA12(Double)



Coiled tubes





Application: air braking systems, Standard: ISO 7375, $\varnothing 12$ , $\varnothing 100$ 

SORL #	 Thread	Coils	Colour	Material
RLD5-F024	 NPT1/2	24	Red	PA12
RLD5-F024BM22	 M22x1.5	24	Red	PA12(Double)
RLD5-F024DM16	 M16x1.5 Copper	24	Red	PA12(Double)



Coiled tubes





Application: air braking systems, Standard: ISO 7375, $\varnothing 12$ , $\varnothing 100$ 

SORL #	 Thread	Coils	Colour	Material
RLD5-F025	 NPT1/2	26	Red	PA12
RLD5-F025BM22	 M22x1.5	26	Red	PA12(Double)
RLD5-F025DM16	 M16x1.5 Copper	26	Red	PA12(Double)



Coiled tubes

Application: air braking systems, Standard: ISO 7375, $\varnothing 12$ , $\varnothing 100$ 

SORL #	 Thread	Coils	Colour	Material
RLD5-F026	 NPT1/2	28	Red	PA12
RLD5-F026CM22	 M22x1.5	28	Blue	PA12(Double)
RLD5-F026DM16	 M16x1.5 Copper	28	Red	PA12(Double)



Electric Cable

Application: air braking systems, Standard: ISO 7375, $\varnothing 12$ , $\varnothing 100$ 

SORL #	Thread	Coils	Colour	Material
RLD5-QX002	7 Pin	16	Balck	PA12
RLD5-QX004	7 Pin	18	Balck	PA12
RLD5-QX006	7 Pin	20	Balck	PA12
RLD5-F005	7 Pin	22	Balck	PA12
RLD5-QX010	7 Pin	24	Balck	PA12
RLD5-QX012	7 Pin	26	Balck	PA12
RLD5-QX014	7 Pin	28	Balck	PA12



Electric Cable

Application: air braking systems, Standard: ISO 7375, $\varnothing 12$ , $\varnothing 100$ 

SORL #	Thread	Coils	Colour	Material
RLD5-QX001	7 Pin	16	Balck	PA12
RLD5-QX003	7 Pin	18	Balck	PA12
RLD5-QX005	7 Pin	20	Balck	PA12
RLD5-F010	7 Pin	22	Balck	PA12
RLD5-QX009	7 Pin	24	Balck	PA12
RLD5-QX011	7 Pin	26	Balck	PA12
RLD5-QX013	7 Pin	28	Balck	PA12



Electric Cable

Application: air braking systems, Standard: ISO 7375, $\varnothing 12$ , $\varnothing 100$ 

SORL #	Thread	Coils	Colour	Material
RLD5-F005A	7 Pin	22	Black	PA12





Electric Cable

Application: air braking systems, Standard: ISO 7375, $\varnothing 12$ , $\varnothing 100$ 

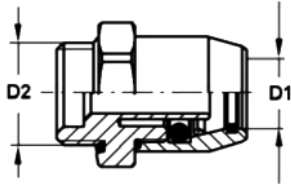
SORL #	Thread	Coils	Colour	Material
RLD5-F010A	7 Pin	22	Black	PA12



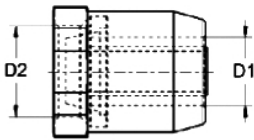
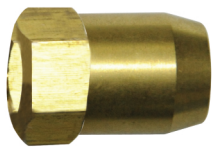

Standard Connectors

SORL #	Pipe Ø D1	 D2	 SW	Material
RL31 011 5	6x1.0	M 12x1.5	18	Br
RL31 013 5	6x1.0	M 16x1.5	22	Br
RL31 014 5	8x1.0	M 10x1.0	18	Br
RL31 018 5	8x1.0	M 22x1.5	28	Br
RL31 020 5	10x1.0	M 12x1.5	20	Br
RL31 021 5	10x1.0	M 14x1.5	20	Br
RL31 026 5	10x1.25	M 22x1.5	28	Br
RL31 033 5	12x1.5	M 16x1.5	22	Br
RL31 040 5	16x2.0	M 12x1.5	26	Br



Standard Connectors

SORL #	Pipe Ø D1	 D2	 SW	Material
RL31 092 5	6x1.0	M 12x1.5	15	CuZn
RL31 093 5	8x1.0	M 14x1.5	17	CuZn
RL31 094 5	10x1.0	M 16x1.5	19	CuZn
RL31 095 5	12x1.5	M 18x1.5	22	CuZn

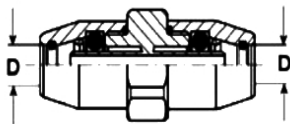

Standard Connectors

SORL #	Pipe Ø D1	Pipe Ø D1	Material
RL31 096 5	4x1.0	4x1.0	Br
RL31 097 5	6x1.0	6x1.0	Br
RL31 098 5	8x1.0	8x1.0	Br
RL31 099 5	10x1.0	10x1.0	Br
RL31 100 5	10x1.25	10x1.25	Br
RL31 101 5	10x1.5	10x1.5	Br
RL31 102 5	11x1.5	11x1.5	Br
RL31 103 5	12x1.5	12x1.5	Br
RL31 104 5	15x1.5	15x1.5	Br
RL31 105 5	15x2	15x2	Br
RL31 106 5	16x2	16x2	Br
RL31 107 5	18x2	18x2	Br

Standard Connectors

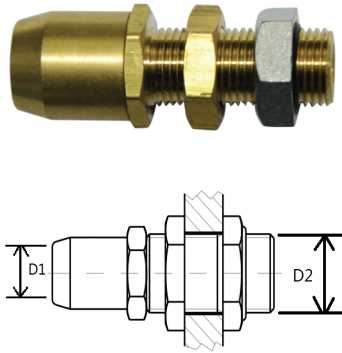

SORL #	Pipe Ø D1	≡ D2	Material
RL31 049 5	6x1.0	M 14x1.5	Br
RL31 053 5	8x1.0	M 12x1.5	Br
RL31 059 5	10x1.0	M 12x1.5	Br
RL31 065 5	10x1.25	M 16x1.5	Br
RL31 071 5	10x1.5	M 16x1.5	Br
RL31 078 5	12x1.5	M 22x1.5	Br
RL31 082 5	15x1.5	M 26x1.5	Br
RL31 087 5	16x2.0	M 16x1.5	Br
RL31 090 5	18x2.0	M 22x1.5	Br

Standard Connectors

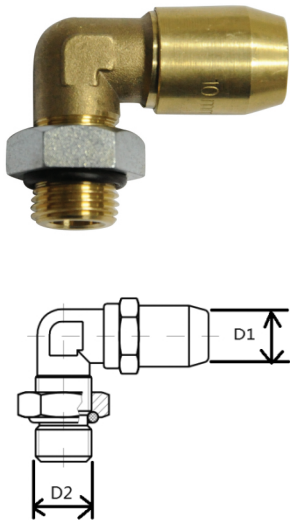

SORL #	Pipe Ø D1	≡ D2	Material
RL32 002 5	6x1.0	M 12x1.5	Br
RL32 007 5	8x1.0	M 12x1.5	Br
RL32 013 5	10x1.0	M 12x1.5	Br
RL32 018 5	10x1.25	M 14x1.5	Br
RL32 024 5	10x1.5	M 14x1.5	Br
RL32 028 5	12x1.5	M 10x1.0	Br
RL32 034 5	15x1.5	M 16x1.5	Br
RL32 037 5	15x2.0	M 16x1.5	Br
RL32 040 5	16x2.0	M 14x1.5	Br
RL32 045 5	18x2.0	M 26x1.5	Br

Standard Connectors

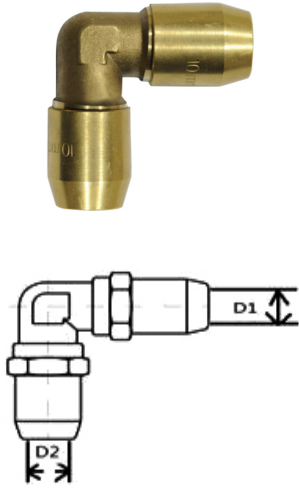

SORL #	Pipe Ø D1	Pipe Ø D1	Material
RL32 046 5	6x1.0	6x1.0	Br
RL32 047 5	8x1.0	8x1.0	Br
RL32 048 5	9x1.5	9x1.5	Br
RL32 049 5	10x1.0	10x1.0	Br
RL32 050 5	11x1.5	11x1.5	Br
RL32 051 5	12x1.5	12x1.5	Br
RL32 052 5	15x1.5	15x1.5	Br
RL32 053 5	16x2.0	16x2.0	Br
RL32 054 5	18x2.0	18x2.0	Br

Standard Connectors

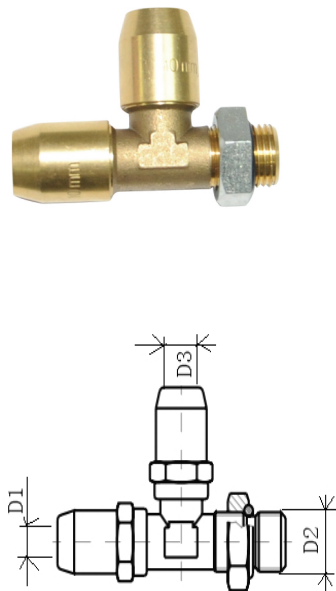

SORL #	Pipe Ø D1	≡ D2	Pipe Ø D3	Material
RL33 004 5	6x1.0	M 12x1.5	6x1.0	Br
RL33 007 5	6x1.0	M 22x1.5	6x1.0	Br
RL33 010 5	8x1.0	M 14x1.5	8x1.0	Br
RL33 015 5	10x1.0	M 12x1.5	10x1.0	Br
RL33 018 5	10x1.0	M 22x1.5	10x1.0	Br
RL33 021 5	10x1.25	M 16x1.5	10x1.25	Br
RL33 025 5	10x1.5	M 14x1.5	10x1.5	Br
RL33 031 5	12x1.5	M 14x1.5	12x1.5	Br
RL33 035 5	15x1.5	M 16x1.5	15x1.5	Br
RL33 040 5	16x2.0	M 12x1.5	16x2.0	Br
RL33 045 5	18x2.0	M 22x1.5	18x2.0	Br

Standard Connectors

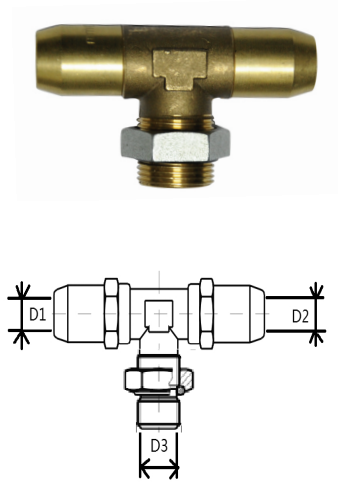

SORL #	Pipe Ø D1	Pipe Ø D2	≡ D3	Material
RL33 048 5	6x1.0	6x1.0	M 12x1.5	Br
RL33 054 5	8x1.0	8x1.0	M 14x1.5	Br
RL33 060 5	10x1.0	10x1.0	M 14x1.5	Br
RL33 063 5	10x1.25	10x1.25	M 12x1.5	Br
RL33 071 5	10x1.5	10x1.5	M 16x1.5	Br
RL33 077 5	12x1.5	12x1.5	M 16x1.5	Br
RL33 081 5	15x1.5	15x1.5	M 22x1.5	Br
RL33 085 5	16x2.0	16x2.0	M 12x1.5	Br
RL33 088 5	16x2.0	16x2.0	M 22x1.5	Br

Standard Connectors

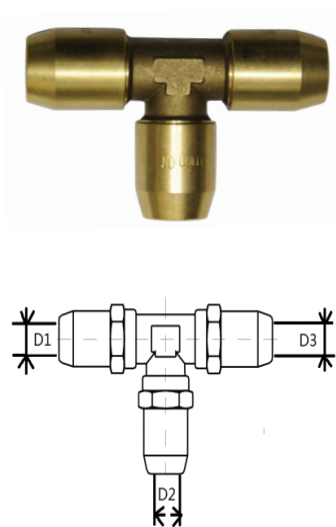

SORL #	Pipe Ø D1	Pipe Ø D2	Pipe Ø D3	Material
RL33 092 5	6x1.0	6x1.0	6x1.0	Br
RL33 093 5	8x1.0	8x1.0	8x1.0	Br
RL33 094 5	9x1.5	9x1.5	9x1.5	Br
RL33 095 5	10x1.0	10x1.0	10x1.0	Br
RL33 096 5	10x1.25	10x1.25	10x1.25	Br
RL33 097 5	10x1.5	10x1.5	10x1.5	Br
RL33 098 5	11x1.5	11x1.5	11x1.5	Br
RL33 099 5	12x1.5	12x1.5	12x1.5	Br
RL33 100 5	15x1.5	15x1.5	15x1.5	Br
RL33 101 5	15x2.0	15x2.0	15x2.0	Br
RL33 102 5	16x2.0	16x2.0	16x2.0	Br
RL33 103 5	18x2.0	18x2.0	18x2.0	Br

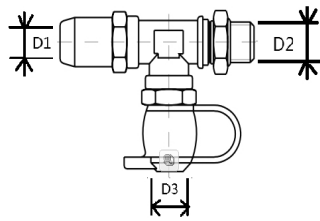

Standard Connectors

SORL #	Pipe Ø D1	≡ D2	≡ D3	Material
RL33 106 5	6x1.0	M 22x1.5	M 12x1.5	Br
RL33 109 5	8x1.0	M 22x1.5	M 12x1.5	Br
RL33 113 5	10x1.0	M 22x1.5	M 12x1.5	Br
RL33 116 5	10x1.25	M 22x1.5	M 12x1.5	Br
RL33 122 5	12x1.5	M 16x1.5	M 16x1.5	Br
RL33 129 5	16x2.0	M 22x1.5	M 16x1.5	Br
RL33 133 5	18x2.0	M 22x1.5	M 16x1.5	Br



Quick Connectors

SORL #	Tube Size	Tube Size	Material
RL31 108 5	4x1.0	4x1.0	Br with nickel plating
RL31 109 5	6x1.0	6x1.0	Br with nickel plating
RL31 110 5	8x1.0	8x1.0	Br with nickel plating
RL31 111 5	9x1.5	9x1.5	Br with nickel plating
RL31 113 5	10x1.25	10x1.25	Br with nickel plating
RL31 114 5	10x1.5	10x1.5	Br with nickel plating
RL31 115 5	11x1.5	11x1.5	Br with nickel plating
RL31 116 5	12x1.5	12x1.5	Br with nickel plating
RL31 117 5	15x1.5	15x1.5	Br with nickel plating
RL31 118 5	15x2.0	15x2.0	Br with nickel plating
RL31 119 5	16x2.0	16x2.0	Br with nickel plating
RL31 120 5	18x2.0	18x2.0	Br with nickel plating



Quick Connectors

SORL #	Tube Size	Tube Size	Material
RL32 138 5	4x1.0	4x1.0	Br with nickel plating
RL32 139 5	6x1.0	6x1.0	Br with nickel plating
RL32 140 5	8x1.0	8x1.0	Br with nickel plating
RL32 141 5	9x1.5	9x1.5	Br with nickel plating
RL32 142 5	10x1.0	10x1.0	Br with nickel plating
RL32 143 5	10x1.25	10x1.25	Br with nickel plating
RL32 144 5	10x1.5	10x1.5	Br with nickel plating
RL32 145 5	11x1.5	11x1.5	Br with nickel plating
RL32 146 5	12x1.5	12x1.5	Br with nickel plating
RL32 147 5	15x1.5	15x1.5	Br with nickel plating
RL32 148 5	15x2.0	15x2.0	Br with nickel plating
RL32 149 5	16x2.0	16x2.0	Br with nickel plating
RL32 150 5	18x2.0	18x2.0	Br with nickel plating

Quick Connectors



SORL #	Thread Size	Tube Size	Material
RL32 057 5	3/8 NPT	4x1.0	Br with nickel plating
RL32 062 5	M 16x1.5	4x1.0	Br with nickel plating
RL32 066 5	1/2 NPT	6x1.0	Br with nickel plating
RL32 071 5	M 22x1.5	6x1.0	Br with nickel plating
RL32 079 5	M 16x1.5	8x1.0	Br with nickel plating
RL32 094 5	M 22x1.5	10x1.0	Br with nickel plating
RL32 099 5	M 12x1.5	10x1.25	Br with nickel plating
RL32 104 5	3/8 NPT	10x1.5	Br with nickel plating
RL32 110 5	M 16x1.5	10x1.5	Br with nickel plating
RL32 115 5	1/2 NPT	12x1.5	Br with nickel plating
RL32 120 5	M 16x1.5	12x1.5	Br with nickel plating
RL32 126 5	M 16x1.5	15x1.5	Br with nickel plating
RL32 133 5	M 16x1.5	16x2.0	Br with nickel plating
RL32 136 5	M 22x1.5	18x2.0	Br with nickel plating

Quick Connectors



SORL #	Tube Size	Tube Size	Tube Size	Material
RL33 219 5	4x1.0	4x1.0	4x1.0	Br with nickel plating
RL33 220 5	6x1.0	6x1.0	6x1.0	Br with nickel plating
RL33 221 5	8x1.0	8x1.0	8x1.0	Br with nickel plating
RL33 222 5	9x1.5	9x1.5	9x1.5	Br with nickel plating
RL33 223 5	10x1.0	10x1.0	10x1.0	Br with nickel plating
RL33 224 5	10x1.25	10x1.25	10x1.25	Br with nickel plating
RL33 225 5	10x1.5	10x1.5	10x1.5	Br with nickel plating
RL33 226 5	11x1.5	11x1.5	11x1.5	Br with nickel plating
RL33 227 5	12x1.5	12x1.5	12x1.5	Br with nickel plating
RL33 228 5	15x1.5	15x1.5	15x1.5	Br with nickel plating
RL33 229 5	15x2.0	15x2.0	15x2.0	Br with nickel plating
RL33 230 5	16x2.0	16x2.0	16x2.0	Br with nickel plating
RL33 231 5	18x2.0	18x2.0	18x2.0	Br with nickel plating



Quick Connectors

SORL #	Thread Size	Tube Size	Tube Size	Material
RL33 151 5	M 16x1.5	6x1.0	6x1.0	Br with nickel plating
RL33 161 5	M 22x1.5	8x1.0	8x1.0	Br with nickel plating
RL33 164 5	3/8 NPT	9x1.5	9x1.5	Br with nickel plating
RL33 178 5	1/2 NPT	10x1.25	10x1.25	Br with nickel plating
RL33 187 5	3/4 NPT	10x1.5	10x1.5	Br with nickel plating
RL33 195 5	3/8 NPT	12x1.5	12x1.5	Br with nickel plating
RL33 196 5	1/2 NPT	12x1.5	12x1.5	Br with nickel plating
RL33 199 5	M 12x1.5	12x1.5	12x1.5	Br with nickel plating
RL33 201 5	M 16x1.5	12x1.5	12x1.5	Br with nickel plating
RL33 202 5	M 22x1.5	12x1.5	12x1.5	Br with nickel plating
RL33 204 5	1/2 NPT	15x1.5	15x1.5	Br with nickel plating
RL33 212 5	M 12x1.5	16x2.0	16x2.0	Br with nickel plating
RL33 217 5	M 22x1.5	18x2.0	18x2.0	Br with nickel plating



SORL #	Thread Size	Tube Size	Material
RL31 123 5	3/8 NPT	4x1.0	Br with nickel plating
RL31 128 5	M 16x1.5	4x1.0	Br with nickel plating
RL31 131 5	3/8 NPT	6x1.0	Br with nickel plating
RL31 137 5	M 22x1.5	6x1.0	Br with nickel plating
RL31 140 5	3/8 NPT	8x1.0	Br with nickel plating
RL31 145 5	M 16x1.5	8x1.0	Br with nickel plating
RL31 149 5	3/8 NPT	9x1.5	Br with nickel plating
RL31 157 5	M 12x1.5	10x1.0	Br with nickel plating
RL31 161 5	1/4 NPT	10x1.25	Br with nickel plating
RL31 167 5	M 16x1.5	10x1.25	Br with nickel plating
RL31 170 5	3/8 NPT	10x1.5	Br with nickel plating
RL31 177 5	M 22x1.5	10x1.5	Br with nickel plating
RL31 180 5	3/8 NPT	12x1.5	Br with nickel plating
RL31 192 5	M 16x1.5	15x1.5	Br with nickel plating
RL31 199 5	M 16x1.5	16x2.0	Br with nickel plating
RL31 203 5	M 22x1.5	18x2.0	Br with nickel plating
RL31 207 5	1/8 NPT	3/8"	Br with nickel plating
RL31 215 5	3/8 NPT	3/8"	Br with nickel plating
RL31 220 5	1/2 NPT	1/2"	Br with nickel plating

Quick Connectors



SORL #	Tube size	Tube Size	Material
RL31 008 3	4x1.0	4x1.0	Plastic
RL31 009 3	6x1.0	6x1.0	Plastic
RL31 010 3	8x1.0	8x1.0	Plastic
RL31 012 3	10x1.0	10x1.0	Plastic
RL31 013 3	10x1.25	10x1.25	Plastic
RL31 014 3	10x1.5	10x1.5	Plastic
RL31 016 3	12x1.5	12x1.5	Plastic
RL31 017 3	15x1.5	15x1.5	Plastic
RL31 018 3	15x2.0	15x2.0	Plastic
RL31 019 3	16x2.0	16x2.0	Plastic
RL31 020 3	18x2.0	18x2.0	Plastic
RL31 021 3	1/8"	1/8"	Plastic
RL31 022 3	1/4"	1/4"	Plastic
RL31 023 3	3/8"	3/8"	Plastic
RL31 024 3	1/2"	1/2"	Plastic
RL31 025 3	1/8"	1/8"	Plastic



SORL #	Tube size	Tube Size	Material
RL32 001 3	4x1.0	4x1.0	Plastic
RL32 002 3	6x1.0	6x1.0	Plastic
RL32 003 3	8x1.0	8x1.0	Plastic
RL32 005 3	10x1.0	10x1.0	Plastic
RL32 006 3	10x1.25	10x1.25	Plastic
RL32 007 3	10x1.5	10x1.5	Plastic
RL32 009 3	12x1.5	12x1.5	Plastic
RL32 010 3	15x1.5	15x1.5	Plastic
RL32 011 3	15x2.0	15x2.0	Plastic
RL32 012 3	16x2.0	16x2.0	Plastic
RL32 013 3	18x2.0	18x2.0	Plastic
RL32 014 3	1/8"	1/8"	Plastic
RL32 015 3	1/4"	1/4"	Plastic
RL32 016 3	3/8"	3/8"	Plastic
RL32 017 3	1/2"	1/2"	Plastic



Quick Connectors

SORL #	Thread Size	Tube Size	Material
RL32 030 3	4x1.0	4x1.0	Plastic
RL32 031 3	6x1.0	6x1.0	Plastic
RL32 032 3	8x1.0	8x1.0	Plastic
RL32 036 3	10x1.5	10x1.5	Plastic
RL32 039 3	15x1.5	15x1.5	Plastic
RL32 043 3	1/8 NPT	1/8 NPT	Plastic
RL32 049 3	1/4 NPT	1/4 NPT	Plastic
RL32 053 3	3/8 NPT	3/8 NPT	Plastic
RL32 057 3	1/2 NPT	1/2 NPT	Plastic



SORL #	Tube Size	Tube Size	Tube Size	Material
RL33 005 3	4x1.0	4x1.0	4x1.0	Plastic
RL33 006 3	6x1.0	6x1.0	6x1.0	Plastic
RL33 007 3	8x1.0	8x1.0	8x1.0	Plastic
RL33 009 3	10x1.0	10x1.0	10x1.0	Plastic
RL33 010 3	10x1.25	10x1.25	10x1.25	Plastic
RL33 011 3	10x1.5	10x1.5	10x1.5	Plastic
RL33 013 3	12x1.5	12x1.5	12x1.5	Plastic
RL33 014 3	15x1.5	15x1.5	15x1.5	Plastic
RL33 015 3	15x2.0	15x2.0	15x2.0	Plastic
RL33 016 3	16x2.0	16x2.0	16x2.0	Plastic
RL33 017 3	18x2.0	18x2.0	18x2.0	Plastic
RL33 018 3	1/8"	1/8"	1/8"	Plastic
RL33 019 3	1/4"	1/4"	1/4"	Plastic
RL33 020 3	3/8"	3/8"	3/8"	Plastic
RL33 021 3	1/2"	1/2"	1/2"	Plastic



Conventional Elbows

SORL #	D1	D2	Material
00 03002 142 831 4 02	NPT3/8	M14x1.5	Steel

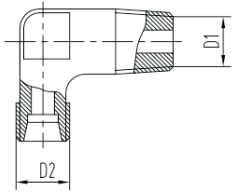

Conventional T Connectors

SORL #	D1	D2	Material
00 03161 142 142 4 02	M16x1.5	2xM14x1.5	Steel

